

Trademarks

Autel®, MaxiIM®, MaxiSys®, MaxiDAS®, MaxiScan®, MaxiTPMS®, MaxiRecorder®, and MaxiCheck® are trademarks of Autel Intelligent Technology Corp., Ltd., registered in China, the United States and other countries. All other marks are trademarks or registered trademarks of their respective holders.

Copyright Information

No part of this manual may be reproduced, stored in a retrieval system or transmitted, in any form or by any means, electronic, mechanical, photocopying, recording, or otherwise without the prior written permission of Autel.

Disclaimer of Warranties and Limitation of Liabilities

All information, specifications and illustrations in this manual are based on the latest information available at the time of printing.

Autel reserves the right to make changes at any time without notice. While information of this manual has been carefully checked for accuracy, no guarantee is given for the completeness and correctness of the contents, including but not limited to the product specifications, functions, and illustrations.

Autel will not be liable for any direct, special, incidental, indirect damages or any economic consequential damages (including the loss of profits).

IMPORTANT

Before operating or maintaining this unit, please read this manual carefully, paying extra attention to the safety warnings and precautions.

For Services and Support:



pro.autel.com
www.autel.com



1-855-288-3587/1-855-AUTELUS (North America)
0086-755-86147779 (China)



support@autel.com

For technical assistance in all other markets, please contact your local selling agent.

Safety Information

For your own safety and the safety of others, and to prevent damage to the device and vehicles upon which it is used, it is important that the safety instructions presented throughout this manual be read and understood by all persons operating or coming into contact with the device.

There are various procedures, techniques, tools, and parts for servicing vehicles, as well as in the skill of the person doing the work. Because of the vast number of test applications and variations in the products that can be tested with this equipment, we cannot possibly anticipate or provide advice or safety messages to cover every circumstance. It is the automotive technician's responsibility to be knowledgeable of the system being tested. It is crucial to use proper service methods and test procedures. It is essential to perform tests in an appropriate and acceptable manner that does not endanger your safety, the safety of others in the work area, the device being used, or the vehicle being tested.

Before using the device, always refer to and follow the safety messages and applicable test procedures provided by the manufacturer of the vehicle or equipment being tested. Use the device only as described in this manual. Read, understand, and follow all safety messages and instructions in this manual.

Safety Messages

Safety messages are provided to help prevent personal injury and equipment damage. All safety messages are introduced by a signal word indicating the hazard level.

DANGER

Indicates an imminently hazardous situation which, if not avoided, will result in death or serious injury to the operator or to bystanders.

WARNING

Indicates a potentially hazardous situation which, if not avoided, could result in death or serious injury to the operator or to bystanders.

Safety Instructions

The safety messages herein cover situations Autel is aware of. Autel cannot know, evaluate or advise you as to all of the possible hazards. You must be certain that any condition or service procedure encountered does not jeopardize your personal safety.

DANGER

When an engine is operating, keep the service area **WELL VENTILATED** or attach a building exhaust removal system to the engine exhaust system. Engines produce carbon monoxide, an odorless, poisonous gas that causes slower reaction time and can lead to serious personal injury or loss of life.

SAFETY WARNINGS

- Always perform automotive testing in a safe environment.
- Wear safety eye protection that meets ANSI standards.
- Keep clothing, hair, hands, tools, test equipment, etc. away from all moving or hot engine parts.
- Operate the vehicle in a well-ventilated work area, for exhaust gases are poisonous.
- Put the transmission in PARK (for automatic transmission) or NEUTRAL (for manual transmission) and make sure the parking brake is engaged.
- Put blocks in front of the drive wheels and never leave the vehicle unattended while testing.
- Be extra cautious when working around the ignition coil, distributor cap, ignition wires and spark plugs. These components create hazardous voltages when the engine is running.
- Keep a fire extinguisher suitable for gasoline, chemical, and electrical fires nearby.
- Do not connect or disconnect any test equipment while the ignition is on or the engine is running.
- Keep the test equipment dry, clean, free from oil, water or grease. Use a mild detergent on a clean cloth to clean the outside of the equipment as necessary.
- Do not drive the vehicle and operate the test equipment at the same time. Any distraction may cause an accident.
- Refer to the service manual for the vehicle being serviced and adhere to all diagnostic procedures and precautions. Failure to do so may result in personal injury or damage to the test equipment.
- To avoid damaging the test equipment or generating false data, make sure the vehicle battery is fully charged and the connection to the vehicle DLC is clean and secure.
- Do not place the test equipment on the distributor of the vehicle. Strong electro-magnetic interference can damage the equipment.

CONTENTS

1	USING THIS MANUAL	1
1.1	CONVENTIONS	1
1.1.1	<i>Bold Text</i>	1
1.1.2	<i>Notes and Important Messages</i>	1
1.1.3	<i>Hyperlink</i>	2
1.1.4	<i>Illustrations</i>	2
1.1.5	<i>Procedures</i>	2
2	GENERAL INTRODUCTION	3
2.1	MAXIIM IM508S TABLET	3
2.1.1	<i>Function Description</i>	3
2.1.2	<i>Power Sources</i>	5
2.1.3	<i>Technical Specifications</i>	5
2.1.4	<i>Accessory Kit</i>	6
2.2	XP200 KEY PROGRAMMER	7
2.2.1	<i>Components and Ports</i>	8
2.2.2	<i>Specifications</i>	15
2.2.3	<i>Accessories Included</i>	15
3	GETTING STARTED	16
3.1	POWERING UP	16
3.1.1	<i>Application Buttons</i>	17
3.1.2	<i>Locator and Navigation Buttons</i>	18
3.1.3	<i>System Status Icons</i>	19
3.2	POWERING DOWN	19
3.2.1	<i>Reboot System</i>	20
4	IMMO	21
4.1	GETTING STARTED	21
4.1.1	<i>Vehicle Menu Layout</i>	21
4.2	VEHICLE IDENTIFICATION	22
4.2.1	<i>Auto VIN Scan</i>	23
4.2.2	<i>Manual VIN Input</i>	23
4.2.3	<i>Automatic Selection</i>	24
4.2.4	<i>Manual Selection</i>	24
4.3	NAVIGATION	25

4.3.1	<i>IMMO Screen Layout</i>	25
4.3.2	<i>Screen Messages</i>	27
4.3.3	<i>Making Selections</i>	28
4.4	<i>IMMO</i>	28
4.4.1	<i>Automatic Selection</i>	28
4.4.2	<i>Manual Selection</i>	36
4.4.3	<i>System Selection</i>	36
5	PROGRAMMER	37
5.1	OPERATIONS	37
6	DIAGNOSTICS	41
6.1	DIAGNOSIS	41
6.1.1	<i>Auto Scan</i>	42
6.1.2	<i>Control Unit</i>	43
6.2	GENERIC OBDII OPERATIONS	55
6.2.1	<i>General Procedure</i>	56
6.2.2	<i>Function Descriptions</i>	57
6.3	EXITING DIAGNOSTICS	59
7	SERVICE	61
7.1	OIL RESET	61
7.2	ELECTRONIC PARKING BRAKE (EPB)	62
7.2.1	<i>EPB Safety</i>	62
7.3	BMS	62
7.4	STEERING ANGLE SENSOR (SAS)	63
7.5	TIRE PRESSURE MONITOR SYSTEM (TPMS)	64
7.6	IMMO KEYS	64
8	UPDATE	65
9	SETTINGS	67
9.1	UNIT	67
9.2	LANGUAGE	67
9.3	PRINTING SETTINGS	68
9.4	REPORT SETTINGS	69
9.5	FIRMWARE UPGRADE	69
9.6	AUTO UPDATE	70
9.7	VEHICLE LIST	70
9.8	SYSTEM SETTINGS	70

9.9	ABOUT	71
10	REMOTE DESKTOP	72
11	DATA MANAGER	74
11.1	VEHICLE HISTORY	75
11.1.1	<i>Historical Test</i>	76
11.2	IMAGE FILES	77
11.3	PDF FILES	78
11.4	REVIEW DATA	78
11.5	UNINSTALL APPS.....	79
11.6	DATA LOGGING	79
11.7	WORKSHOP INFORMATION.....	79
11.8	CUSTOMER.....	80
11.9	REPORT	82
12	MAXVIEWER.....	83
13	SUPPORT	84
13.1	PRODUCT REGISTRATION.....	84
13.2	SUPPORT SCREEN LAYOUT	85
13.2.1	<i>My Account</i>	85
13.2.2	<i>Data Logging</i>	85
13.2.3	<i>Training</i>	86
13.2.4	<i>FAQ</i>	86
14	QUICK LINK	87
15	MAINTENANCE AND SERVICE	88
15.1	MAINTENANCE INSTRUCTIONS.....	88
15.2	TROUBLESHOOTING CHECKLIST	88
15.3	ABOUT BATTERY USAGE	89
16	COMPLIANCE INFORMATION	91
17	WARRANTY	93

1 Using this Manual

This manual contains device usage instructions.

Some illustrations shown in this manual may contain modules and optional equipment that are not included in your system.

1.1 Conventions

The following conventions are used.

1.1.1 Bold Text

Bold text is used to highlight selectable items such as buttons and menu options.

Example:

- Tap **OK**.

1.1.2 Notes and Important Messages

Notes

A **NOTE** provides helpful information such as additional explanations, tips, and comments.

Example:

NOTE

The images and illustrations depicted in this manual may differ from the actual ones.

Important

IMPORTANT indicates a situation which, if not avoided, may result in damage to the tablet or vehicle.

Example:

IMPORTANT

Always reset the engine oil life to 100% after every oil change.

1.1.3 Hyperlink

Hyperlinks, or links, that take you to other related articles, procedures, and illustrations are available in electronic documents. Blue italic text indicates a selectable hyperlink and blue underlined text indicates a website link or an email address link.

1.1.4 Illustrations

Illustrations used in this manual are samples, the actual testing screen may vary for each vehicle being tested. Observe the menu titles and on-screen instructions to make correct option selection.

1.1.5 Procedures

An arrow icon indicates a procedure. For example:

➤ **To perform Manual Selection**

1. Tap **IMMO** application button on the MaxilM Job Menu.
2. Select the manufacturer icon of the test vehicle.
3. Tap **Manual Selection** and select the test vehicle information such as model, year, key type, etc. Select **OK** to confirm the vehicle information. Follow the on-screen instructions to display the function screen.

2 General Introduction

When it comes to ultra-portability, MaxiIM IM508S is your perfect companion. Installed with a fast quad-core processor, IM508S offers maximum convenience and swift diagnosis. The intuitive user screen makes using the device effortless through a 7-inch LCD touchscreen that displays at 1024 x 600 quality. Together with the ability to quickly read and clear DTCs for all available modules of the majority of the makes and models on the market, IM508S provides you with superior special functions, including Oil Reset, EPB (Electronic Parking Brake), SAS (Steering Angle Sensor), BMS (Battery Management System), DPF (Diesel Particulate Filter), IMMO, and TPMS (Tire Pressure Monitoring System). With the key programmer XP200, IM508S is capable of providing extraordinary functions for the immobilizer system.

This manual describes the construction and operation of the tools and how they work together to deliver diagnostics solutions.

2.1 MaxiIM IM508S Tablet

2.1.1 Function Description

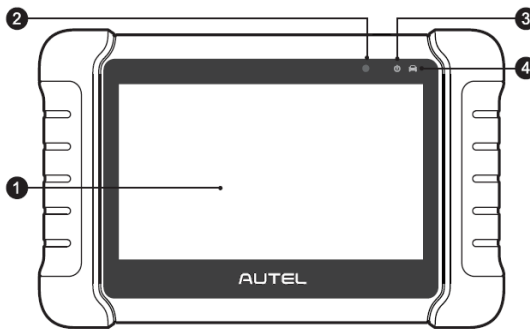

Figure 2-1 MaxiIM Tablet, Front View

1. 7.0" LCD Capacitive Touchscreen
2. Ambient Light Sensor — detects ambient brightness.
3. Power LED — indicates battery level & charging or system status.
4. Vehicle Communication LED — flashes green when the Tablet is communicating/linking with the vehicle's system.

The power LED displays green, yellow or red depending on the power level and operating status.

- A. Green
 - Illuminates green when the Tablet is charging and the battery level is above 90%.
 - Illuminates green when the Tablet is powered on and the battery level is above 15%.
- B. Yellow
 - Illuminates yellow when the Tablet is charging and the battery level is below 90%.
- C. Red
 - Illuminates red when the Tablet is powered on and the battery level is below 15%.

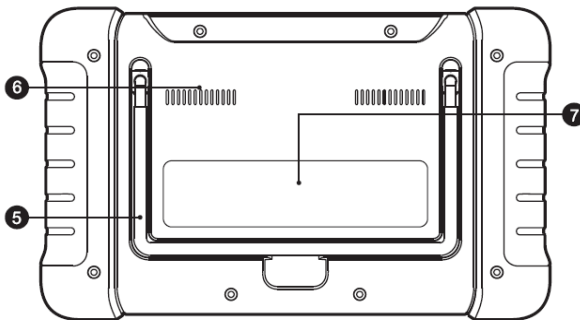

Figure 2-2 MaxilM Tablet, Back View

- 5. Collapsible Stand — extends from the back to allow hands-free viewing of the Tablet.
- 6. Heat Sink
- 7. Built-in Battery

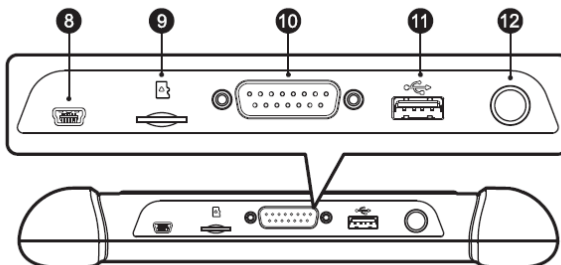

Figure 2-3 MaxilM Tablet, Top View

- 8. Mini USB Port
- 9. Micro SD Card Slot — holds the micro SD card.
- 10. DB15-Pin Port — connects the main cable.

11. USB Port

12. Power/Lock Button — turns the device on & off with long press, or locks the screen with short press.

2.1.2 Power Sources

The Tablet can receive power from any of the following sources:

- Internal Battery Pack
- External Power Supply

2.1.2.1 Internal Battery Pack

The Tablet can be powered with the internal rechargeable battery, which if fully charged can provide sufficient power for about 7 hours of continuous operation.

2.1.2.2 External Power Supply

The Tablet can be powered from a wall socket using the mini USB cable and USB external power adapter. The external power supply also charges the internal battery pack.

2.1.3 Technical Specifications

Table 2-1 Technical Specifications

Item	Description
Recommended Use	Indoor
Operating System	Android™ 11
Processor	Cortex®-A55 processor (1.8 GHz)
Memory	64 GB
Display	7-inch LCD capacitive touchscreen with 1024 x 600 resolution
Connectivity	<ul style="list-style-type: none">● Mini USB● USB 2.0● Wi-Fi● Micro SD card (supports up to 32 GB)
Sensors	Ambient light sensor
Audio Input/Output	<ul style="list-style-type: none">● Input: N/A● Output: buzzer
Power and Battery	<ul style="list-style-type: none">● 3.7 V/5000 mAh lithium-polymer battery

Item	Description
	<ul style="list-style-type: none"> Charges via 5 VDC power supply
Tested Battery Life	Around 7 hours of continuous use
Battery Charging Input	5 V/1.5 A
Power Consumption	500 mA (LCD on with default brightness, Wi-Fi on) @3.7 V
Operating Temp.	0 to 50 °C (32 to 122 °F)
Storage Temp.	-20 to 60 °C (-4 to 140 °F)
Operating Humidity	5 % - 95 % non-condensing
Dimensions (W x H x D)	237.8 mm (9.4") x 148.6 mm (5.9") x 35.5 mm (1.4")
Net Weight	788 g (2.42 lbs.)
Supported Automotive Protocols	ISO9141-2, ISO14230-2,ISO15765, K/L-Line, Flashing Code, SAE-J1850 VPW, SAE-J1850 PWM, ISO11898(Highspeed, Middlespeed, Lowspeed and Singlewire CAN,fault-tolerant CAN), SAE J2610,GM UART,UART Echo Byte Protocol, Honda Diag-H Protocol, TP2.0, TP1.6

2.1.4 Accessory Kit

2.1.4.1 Main Cable

The Main Cable connects the Tablet to the vehicle's data link connector (DLC).

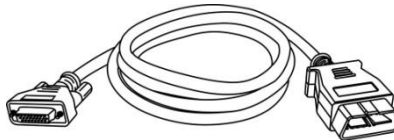

Figure 2-4 Main Cable

2.1.4.2 Other Accessories



Mazda-17 Adapter



KIA-10 Adapter



KIA-20 Adapter



Honda-3 Adapter



AAC001



Mini USB Cable

Connects the Tablet to the PC or DC external power adapter.



Power Adapter

Together with the mini USB cable, connects the Tablet to the external DC power port for power supply.

2.2 XP200 Key Programmer

The XP200 Key Programmer is specially designed to read Volkswagen vehicle key chip data, clone and generate exclusive keys, read/write on-board EEPROM data, and read/write Freescale 9S12 MCUs. By working with the Tablet and PC that are both loaded with programmer software, the XP200 Key Programmer can read/write key chip data quickly and accurately.

2.2.1 Components and Ports

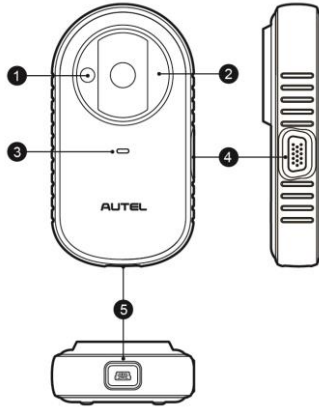

Figure 2-5 XP200 Views

1. Vehicle Key Chip Slot — holds the vehicle key chip to read and write vehicle key chip information.
2. Vehicle Key Slot — holds the vehicle key to read and write vehicle key information.
3. Status LED Light — indicates the current operating status.
4. Connection Port — connects the EEPROM Adapter and the EEPROM Clamp Integrated MC9S12 Cable.
5. Mini USB Port — provides data communication and power supply.

2.2.1.1 Status LED Light

The status LED of the XP200 Key Programmer indicates the operating status of the device. See the following table for detailed descriptions.

Table 2-3 Status LED Light

LED	Color	Description
Status LED	Red	<ul style="list-style-type: none"> • Lights red when the firmware is upgrading or an error has occurred. • Lights red briefly when the device is powered on and performing self-check.
	Green	<ul style="list-style-type: none"> • Flashes green when communicating via USB cable. • Lights green when the device is ready for use.

2.2.1.2 Connection Port

There are two accessories that can be paired with the connection port: EEPROM Clamp Integrated MC9S12 Cable and EEPROM Adapter.

EEPROM Clamp Integrated MC9S12 Cable

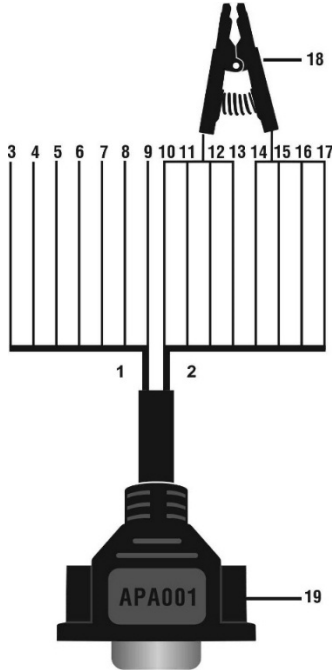

Figure 2-6 EEPROM Clamp Integrated MC9S12 Cable

1. MC9S12 Cable

Table 2-4 Definitions of MC9S12 Cable

No.	Color	Definition	Pin corresponding to DB15	Note
3	Green	TXCLKS	1	N/A
4	Black	GND	2	Shielded line
5	White	TOSC	6	Shielded line
6	Blue	TSW	7	N/A
7	Brown	GND	8	N/A

No.	Color	Definition	Pin corresponding to DB15	Note
8	Yellow	TRESET	11	N/A
9	Red	VDD	12	N/A

2. EEPROM Clamp Cable

Table 2-5 Definitions of EEPROM Clamp Cable

No.	Color	Definition	Pin corresponding to DB15	Note
10	White and Red	P1	5	Pin 1 is red
11	White and Purple	P2	15	N/A
12	White and Blue	P3	10	N/A
13	Grey	P4	4	N/A
14	White and Brown	P5	14	N/A
15	White and Green	P6	9	N/A
16	White and Orange	P7	3	N/A
17	White and Black	P8	13	Pin 8 is black

Here are the possible causes for EEPROM read/write failure and data error when connecting the clamp to the test board for EEPROM read/write:

- A. EEPROM read/write operations are affected by the circuit of the connected test board;
- B. EEPROM read/write operations of the test board are affected by the read/write operations of the clamp;
- C. The signal is damaged by large resistance. A large resistance will be generated when connecting the clamp to a fast communicating EEPROM or using a long cable for connection.

Therefore, it is recommended to dismantle the chip on the EEPROM, weld the EEPROM to the EEPROM Adapter or place in the EEPROM socket, and then insert it in the EEPROM Adapter.

18. EEPROM Clamp

19. DB15 VGA Port

EEPROM Adapter

The EEPROM Adapter is compatible with three 8-pin packaging TSSOP, SOP, DIP connections, and each packaging reserves three same ports, so the device will function properly when one port is damaged. For SOP8 packaging, the EEPROM Adapter can also work with the EEPROM socket. To do this, place the pins of the SOP8 EEPROM into the EEPROM accordingly and then insert them into the EEPROM Adapter.

2.2.1.3 EEPROM Read/Write Supported Types

Table 2-6 EEPROM Read/Write Supported Types

Chip Type	Name	Chip Type	Name
ATMEL	AT24C01	ST	M24C04
ATMEL	AT24C02	ST	M24C08
ATMEL	AT24C04	ST	M24C16
ATMEL	AT24C08	ST	M24C32
ATMEL	AT24C16	ST	M24C64
ATMEL	AT24C32	FAIRCHILD	NM24C16U
ATMEL	AT24C64	FAIRCHILD	NM24C16UT
ATMEL	AT24C128	FAIRCHILD	NM24C17U
ATMEL	AT24C256	FAIRCHILD	NM24C17UT
ATMEL	AT24C512	MICROCHIP	85C72
ATMEL	AT24C1024	MICROCHIP	85C82
ATMEL	AT24C128_1.8	MICROCHIP	85C92
ATMEL	AT24C256_1.8	NXP	PCF8582C
ATMEL	AT24C512_1.8	NXP	PCF8594C
ATMEL	AT24C01A	NXP	PCF8598C
ST	ST24x01/ST25x01	ATMEL	AT25010
ST	ST24x02/ST25x02	ATMEL	AT25020
ST	ST24x04/ST25x04	ATMEL	AT25040
ST	ST24x08/ST25x08	ATMEL	AT25080

Chip Type	Name	Chip Type	Name
ST	ST24x16/ST25x16	ATMEL	AT25160
ST	M24C01	ATMEL	AT25320
ST	M24C02	ATMEL	AT25640
ATMEL	AT25128	MICROCHIP	25xx080
ATMEL	AT25256	MICROCHIP	25xx160
ATMEL	AT25512	MICROCHIP	25xx320
ATMEL	AT25010_1.8	MICROCHIP	25xx640
ATMEL	AT25020_1.8	MICROCHIP	25xx040_TSSOP
ATMEL	AT25040_1.8	MICROCHIP	25xx320_TSSOP
ATMEL	AT25080_1.8	MICROCHIP	25xx640_TSSOP
ATMEL	AT25160_1.8	CATALYST	CAT25C01
ATMEL	AT25320_1.8	CATALYST	CAT25C02
ATMEL	AT25640_1.8	CATALYST	CAT25C04
ATMEL	AT25128_1.8	CATALYST	CAT25C08
ATMEL	AT25256_1.8	CATALYST	CAT25C16
ST	M95010	CATALYST	CAT25C32
ST	M95020	CATALYST	CAT25C64
ST	M95040	CATALYST	CAT25C128
ST	M95080	CATALYST	CAT25C256
ST	M95160	ST	M35080
ST	M95320	XICOR	X5043
ST	M95640	XICOR	X5045
ST	M95128	XICOR	X25043
ST	M95256	XICOR	X25045
ST	M95512	MICROCHIP	93C06
MICROCHIP	25xx040	NATIONAL	NM93C13
NATIONAL	NM93C14	NATIONAL	NM93CS06

Chip Type	Name	Chip Type	Name
NATIONAL	NM93C14TM8	NATIONAL	NM93CS46
MICROCHIP	93C46X	NATIONAL	NM93CS56
MICROCHIP	93C46A	NATIONAL	NM93CS66
MICROCHIP	93C46	FAIRCHILD	FM93CS46T
MICROCHIP	93C46AX	ST	M93C46
MICROCHIP	93C46BX_93C46CX	ST	M93C56
MICROCHIP	93C56A	ST	M93C66
MICROCHIP	93C56	ST	M93C76
MICROCHIP	93C66A	ST	M93C86
MICROCHIP	93C66	ST	M93S46
MICROCHIP	93C76A	ST	M93S56
MICROCHIP	93C76	ST	M93S66
MICROCHIP	93C86A	ATMEL	AT59C11
MICROCHIP	93C86	ATMEL	AT59C22
ATMEL	AT93C46A	ATMEL	AT59C13
ATMEL	AT93C46	OKI	MSM16911
ATMEL	AT93C46R	TMC	TMC93LC46
ATMEL	AT93C56	TMC	TMC93LC56
ATMEL	AT93C57	TMC	TMC93LC57
ATMEL	AT93C66	TMC	TMC93LC66
ATMEL	AT93C76	TMC	TMC93LC86
ATMEL	AT93C86	SONY	CXK1011
SONY	CXK1012	Seiko	S_24S45
SONY	CXK1013	TOSHIBA	TC89101
Seiko	S_24H30	TOSHIBA	TC89102
Seiko	S_24H30_SOP8	TOSHIBA	TC89121
Seiko	S_24H45	TOSHIBA	TC89122

Chip Type	Name	Chip Type	Name
Seiko	S_24H45_SOP8	Xicor	X24C44
Seiko	S_24S30		

2.2.1.4 *MC9S12 Read/Write Supported Types*

Table 2-7 MC9S12 Read/Write Supported Types

Chip Type	Name
FREESCALE	MC9S12DG128

2.2.2 Specifications

Table 2-2 Specifications

Item	Description
Operating Temperature	-10 to 50 °C (14 to 122 °F)
Storage Temperature	-20 to 60 °C (-4 to 140 °F)
Port	Mini USB, VGA_DB15
Input Voltage	5 VDC
Operating Current	< 250 mA
Maximum Consumption	1 W
Device Dimensions (L x W x H)	130 mm (5.1") x 68 mm (2.7") x 28 mm (1.1")
Package Dimensions (L x W x H)	201 mm (7.9") x 167 mm (6.6") x 75 mm (3")
Net Weight	466 g (1.03 lbs.)

2.2.3 Accessories Included



APB001 — EEPROM Adapter



APB002 — 68HC908 Adapter

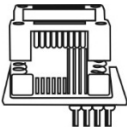

APA002 — EEPROM Socket

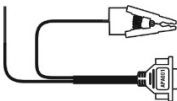

APA001 — EEPROM Clamp Integrated
MC9S12 Cable

3 Getting Started

Ensure the tablet is sufficiently charged or is connected to the external power supply (see [Power Sources](#)).

NOTE

The images and illustrations depicted in this manual may differ from the actual ones.

3.1 Powering Up

Long press the **Power/Lock** button on the top-right of the tablet to power on the unit. The power LED will illuminate green. The system boots up and displays the Lock screen. Swipe up to unlock the screen.

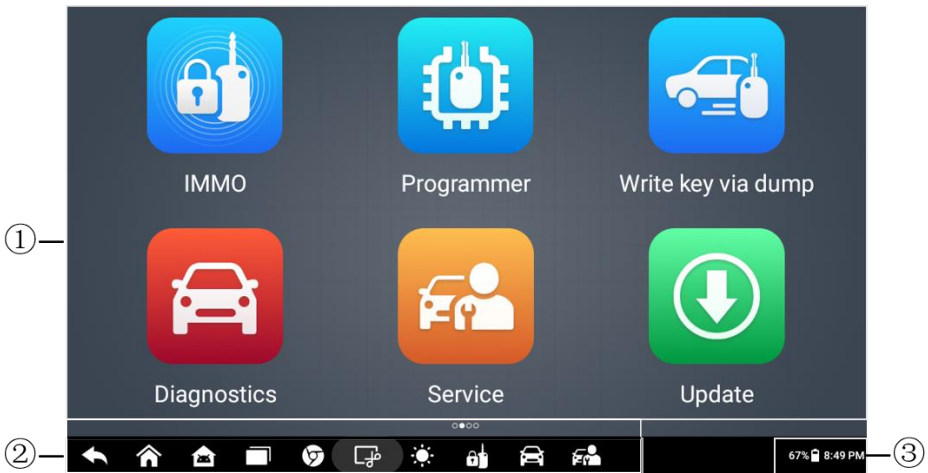

Figure 3-1 Job Menu

1. Application Buttons
2. Locator and Navigation Buttons
3. System Status Icons

NOTE





The tablet screen is locked by default after powered on. It is recommended to lock the screen to protect the information in the system and reduce the power consumption.

The touch screen navigation is menu-driven, which enables quick access to the functions by tapping on the application buttons and answering dialog windows. Detailed descriptions of the menu structures can be found in the application chapters.

3.1.1 Application Buttons

Descriptions of the tool applications are displayed in the table below.











Table 3-1 Applications

Button	Name	Description
	IMMO	Accesses the IMMO functions menu. See IMMO for details.
	Programmer	Accesses the Programming functions menu. See Programmer for details.
	Diagnostics	Accesses the diagnostics functions menu. See Diagnostics for details.
	Service	Accesses the special functions menu. See Service for details.
	Update	Checks and downloads the latest updates available for the MaxiIM system. See Update for details.
	Settings	Accesses MaxiIM system settings menu. See Settings for details.
	Remote Desktop	Configures the unit to receive remote support using the TeamViewer application program. See Remote Desktop for details.
	Data Manager	Accesses the organization system for saved data. See Data Manager for details.
	Support	Synchronizes Autel's online service database with the MaxiIM tablet. See Support for details.
	MaxiViewer	Provides a quick search for supported functions and/or vehicles. See MaxiViewer for details.
	Quick Link	Provides associated website bookmarks to allow quick access to product update, service, support, and other information. See Quick Link for details.

3.1.2 Locator and Navigation Buttons

Operations of the Navigation buttons at the bottom of the screen are described in the table below:

Table 3-2 Locator and Navigation Buttons

Button	Name	Description
	Locator	Indicates the location of the screen. Swipe the screen left or right to view the previous or next screen.
	Back	Returns the previous screen.
	MaxiIM Home	Enters MaxiIM job menu.
	Android Home	Enters Android System's home screen.
	Recent Apps	Displays a list of applications that are currently in use. Tap an app icon to launch. To remove an app, swipe it to the top or bottom.
	Chrome	Launches the Android built-in browser.
	Screenshot	Saves the displayed screen as an image.
	Brightness	Adjusts brightness of screen.
	IMMO Shortcut	Enters the IMMO screen.
	Diagnostic Shortcut	Enters the Diagnostics screen.
	Service Shortcut	Enters the Service screen.

3.1.3 System Status Icons







As the Tablet is working with the Android operating system, you may refer to Android documents for more information.

By sliding down from the top of the screen or tapping on the bottom right corner of the screen, a Shortcut Panel will be displayed, on which you are allowed to set various system settings of the tablet. Operations of each button on the panel are described in the table below:

 **NOTE**

The shortcut buttons will be highlighted when enabled and turn dimmed when disabled.

Table 3-3 Shortcut Panel Buttons

Button	Name	Description
	Wi-Fi	Enables/disables Wi-Fi when pressed.
	Do Not Disturb	Enables/disables Do-Not-Disturb mode.
	Battery	Displays battery status.
	Airplane Mode	Enables/disables Airplane Mode when pressed.
	Location	Enables/disables location recording function.
	Logger	Accesses Log Collection screen.
	System Settings	Launches the Android System Settings screen when pressed.

3.2 Powering Down

All vehicle communications must be terminated before shutting down the Tablet. A warning message displays if you attempt to shut down the Tablet when it is communicating with the vehicle. Forcing a shut-down while communicating may lead to ECM problems on some vehicles. Please exit the Diagnostics application before powering down.

➤ **To power down the tablet**

1. Long press the **Lock/Power** Button.
2. Tap **Power off** option and the tablet will turn off in a few seconds.

3.2.1 Reboot System

In case of a system crash, long press the **Power/Lock** button and tap **Restart** option to restart the system.

4 IMMO

The IMMO application provides Automatic Selection, Manual Selection, and System Selection to guide technicians to perform IMMO-related functions, including Key Learning, Remote Control Learning, Remote Control Add, etc.

4.1 Getting Started

Ensure a communication link is established between the test vehicle and the tablet via the main cable, and the XP200 is connected to the tablet with the supplied USB cable.

4.1.1 Vehicle Menu Layout

When the tablet is properly connected to the vehicle, the platform is ready to start vehicle diagnosis. Tap on the **IMMO** application button on the MaxiIM IM508S Job Menu to access the Vehicle Menu.













Figure 4-1 Vehicle Menu

1. Top Toolbar Buttons
2. Manufacturer Icons

4.1.1.1 Top Toolbar Buttons

The operations of the toolbar buttons at the top of the screen are listed and described in the table below:

Table 4-1 Top Toolbar Buttons

Button	Name	Description
	Home	Returns to the MaxiIM Job Menu.
	VID	Displays a dropdown list; tap Auto Detect for auto VIN detection; tap Manual Input to enter VIN manually.
	All	Displays all the vehicle makes in the vehicle menu.
	Favorites	Displays user-selected favorite vehicle makes.
	History	Displays stored test vehicle records.
	USA	Displays the USA vehicles menu.
	European	Displays the European vehicles menu.
	Asia	Displays the Asian vehicles menu.
	China	Displays the Chinese vehicles menu.
	Search	Displays a virtual keyboard to manually enter a specific vehicle make required.
	Cancel	Exits the search screen or cancels an operation.

4.1.1.2 Manufacturer Icons

Manufacturer Icons display a list of available vehicle brands for testing. Select a corresponding vehicle manufacturer to enter the IMMO program.

4.2 Vehicle Identification

The MaxiIM IMMO system generally supports four methods for Vehicle Identification.

1. Auto VIN Scan
2. Manual VIN Input

3. Automatic Selection
4. Manual Selection

4.2.1 Auto VIN Scan

The MaxiIM IMMO system features the latest VIN-based Auto VIN Scan function to identify vehicles, which is applied to IMMO, Programmer, Diagnostic and Service applications.

➤ **To perform Auto VIN Scan**

1. Tap the **IMMO** application button on the MaxiIM Job Menu. The Vehicle Menu displays.
2. Tap the **VID** button on the top toolbar to open a dropdown list.



Figure 4-2 Auto VIN Screen

3. Select **Auto Detect**. Once the test vehicle is successfully identified, the screen will display the vehicle profile. Tap **OK** at the bottom right to confirm the vehicle profile.
4. Tap **Yes** to confirm the vehicle profile or **No** if the information is not correct.
5. The tablet establishes communication with the vehicle and reads the IMMO control unit information.

4.2.2 Manual VIN Input

For vehicles that not supporting the Auto VIN Scan function, you may manually enter the vehicle VIN.

➤ **To perform Manual VIN Input**

1. Tap the **IMMO** application button on the MaxiIM Job Menu. The Vehicle Menu displays.
2. Tap the **VID** button on the top toolbar.
3. Select **Manual Input**.

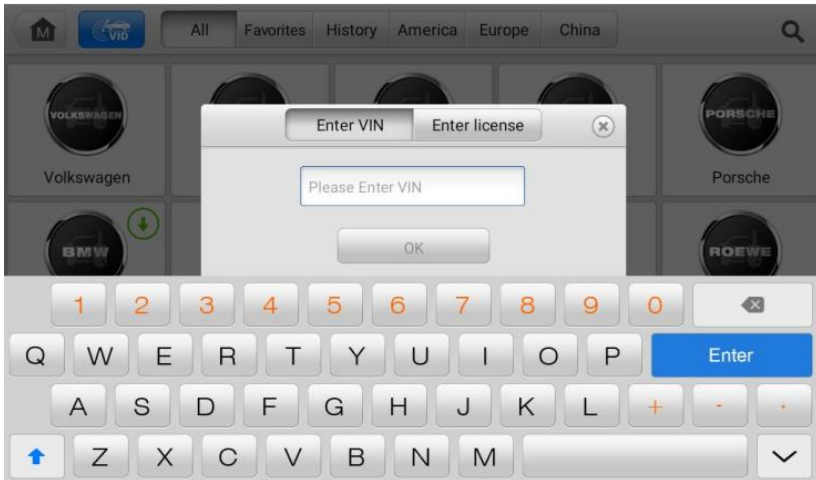

Figure 4-3 Enter VIN Screen

4. Tap the input box and enter the correct VIN.
5. Tap **OK** to complete or tap **X** at the upper-right corner of the pop-up to exit Manual Input.

4.2.3 Automatic Selection

The Automatic Selection can be selected after selecting the test vehicle manufacturer.

➤ **To perform Automatic Selection**

1. Tap the **IMMO** application button on the MaxiIM Job Menu. The Vehicle Menu displays.
2. Tap the manufacturer button of the test vehicle.
3. Tap **Automatic Selection** and the VIN information will be automatically acquired. Follow the on-screen instruction to display the function screen.

4.2.4 Manual Selection

When the vehicle's VIN is not automatically retrievable through the vehicle's ECU, or the specific VIN is unknown, the vehicle can be manually selected.

This mode of vehicle selection is menu driven, repeat the first two steps from the automatic selection operation and tap **Manual Selection**. Through a series of on-screen prompts and selections, the test vehicle is chosen. Press the **ESC** button at the bottom-right corner of the screen to return to the previous screen if needed.

4.3 Navigation

Navigating the IMMO interface and selecting test are described in this section.

4.3.1 IMMO Screen Layout

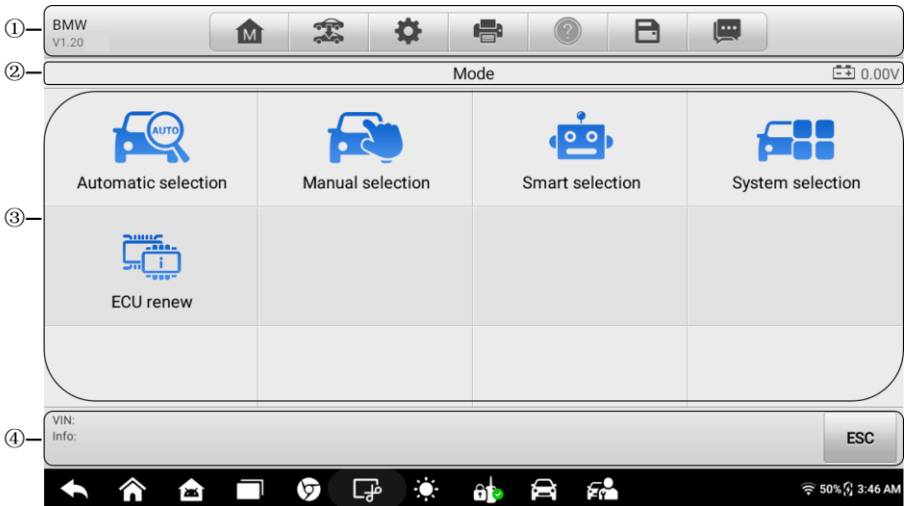

Figure 4-4 IMMO Screen Layout







The IMMO screens typically include four sections:

1. Operation Toolbar
2. Status Information Bar
3. Main Section
4. Function Buttons

4.3.1.1 Operation Toolbar

The Operation Toolbar contains a number of buttons such as print and save. The table below provides a brief description of the operations.

Table 4-2 Operation Toolbar Buttons

Button	Name	Description
	Home	Returns to the MaxiIM Job Menu.
	Vehicle Swap	Exits the diagnostic session of the currently identified test vehicle and returns to the vehicle
	Settings	Opens the settings screen. See Settings .
	Print	Prints a copy of the displayed data. See Printing Settings for additional information.
	Help	Displays operational instructions or tips.
	Save	Tap to open a sub menu, then tap Take a Screenshot to save this screen. All saved data is stored in the Data Manager application for later review. See Data Manager .
	Data Logging	Records the communication data and ECU information of the test vehicle. The saved data can be reported and sent to the technical center via the Internet. You can go to the Support application to follow up the processing progress, see Data Logging for detailed information.

➤ **To print data**

1. Tap the **IMMO** application button from the MaxiIM Job Menu.
2. Tap **Print**. A drop-down menu displays. The **Print** button on the toolbar is available throughout the IMMO operations.
3. Tap **Print This Page** to print a screenshot of the current screen.
4. A temporary file will be created and sent to the connected computer for printing.
5. When the file is transferred successfully, a confirmation message displays.

➤ **To submit Data Logging reports**

1. Tap the **IMMO** application button on the MaxiIM Job Menu.
2. Tap the **Data Logging** button to display the error options. The **Data Logging** button on the toolbar is available throughout the IMMO operations.

3. Select a specific error and tap **OK**. A submission form will display to let you fill in the report information.
4. Tap **Send** to submit the report form via the Internet. A confirmation message displays when sent successful.

4.3.1.2 *Status Information Bar*

The Status Information Bar at the top of the Main Section displays the following items:

1. Menu Title — displays the menu heading of the Main Section.
2. Voltage Icon — displays the vehicle's voltage status.

4.3.1.3 *Main Section*

The Main Section of the screen varies depending on the stage of operations and vehicle brands. The Main Section can display vehicle identification selections, the main menu, test data, messages, instructions, and other information.

4.3.1.4 *Function Buttons*

The displayed Function Buttons vary depending on the stage of operations. They can be used to navigate menus, save or clear data, exit scanning, and perform a number of other control functions. The use of these buttons will be introduced in details in the following sections of the corresponding test operations.

4.3.2 **Screen Messages**

Screen messages appear when additional input is needed before proceeding. There are three main types of on-screen messages: Confirmation, Warning, and Error.

4.3.2.1 *Confirmation Messages*

This type of messages usually displays as an "Information" screen to inform the user that a selected action cannot be reversed or when an action has been initiated and confirmation is needed to continue.

When a user-response is not required to continue, the message displays briefly.

4.3.2.2 *Warning Messages*

This type of messages displays a warning that a selected action may result in an irreversible change or loss of data. An example of this type of message is the "Erase Codes" message.

4.3.2.3 *Error Messages*

Error messages display when a system or procedural error has occurred. Examples of possible errors include a disconnection or communication interruption.

4.3.3 Making Selections

The IMMO application is a menu driven program that presents a series of choices. As a selection is made, the next menu in the series displays. Each selection narrows the focus and leads to the desired test. Tap the screen to make menu selections.

4.4 IMMO

The IMMO application requires a data link to the IMMO electronic control system of the test vehicle for diagnosis via OBDII connection. The application retrieves vehicle IMMO information and performs IMMO-related functions, including Key Learning, Remote Control Learning, and Remote Control Add. There are three available modes when accessing the IMMO section:

1. Automatic Selection
2. Manual Selection
3. System Selection

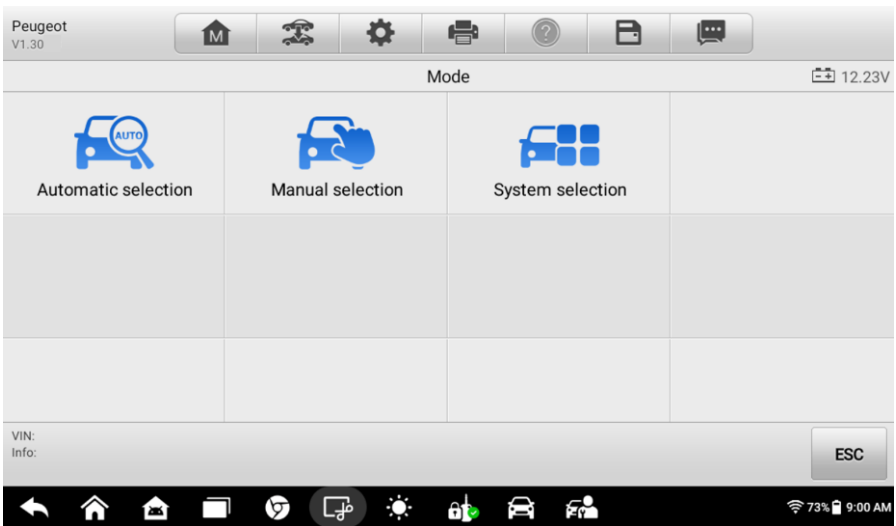

Figure 4-5 IMMO Modes Screen

The available modes displayed on the screen may vary between different vehicle brands.

4.4.1 Automatic Selection

The Automatic Selection provides guided functions with step-by-step instructions. Once the VIN is acquired, a vehicle profile will appear and select **Yes** to continue. There are four main options available when accessing the Automatic Selection:

1. IMMO Status Scan
2. Control Unit
3. Hot Function
4. Vehicle IMMO Information

4.4.1.1 IMMO Status Scan

The IMMO Status Scan function performs a comprehensive scanning over all the systems on the vehicle's IMMO ECU in order to locate fault systems and retrieve DTCs. The sample operation interface of the IMMO Status Scan displays as below.

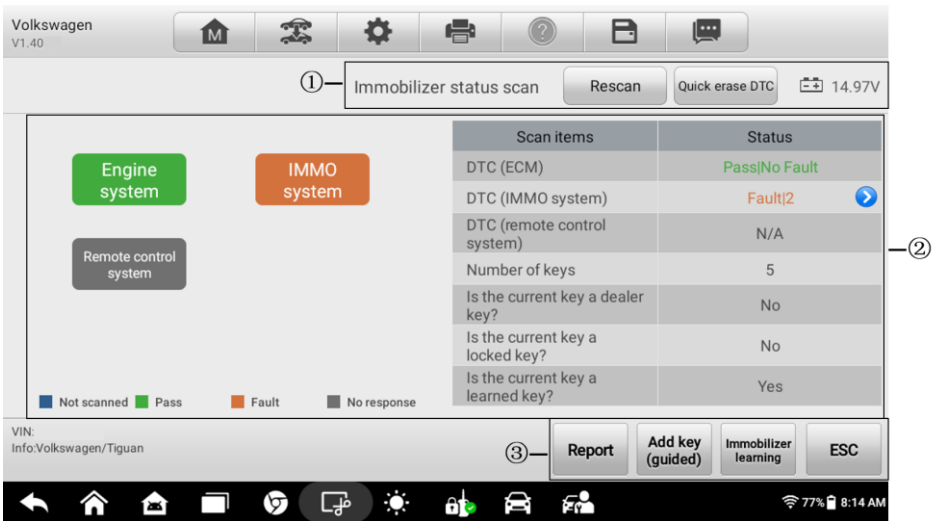

Figure 4-6 IMMO Status Scan Screen

1. Navigation Bar
2. Main Section
3. Function Buttons

Navigation Bar

The Navigation Bar shows the heading of the screen and vehicle's voltage status. There are two options available:

- Rescan — tap to scan the IMMO system for DTCs again.
- Quick erase DTC — tap to erase the fault codes.

Main Section

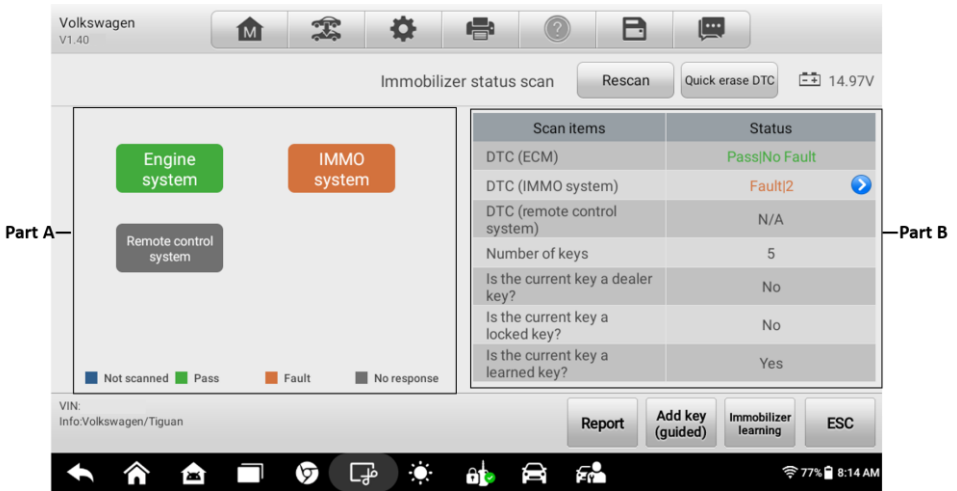

Figure 4-7 Main Section of IMMO Status Scan

Part A displays the scanned systems highlighted in different colors. Each color represents varied status, which you can check on the screen.

Part B displays scan results with the left column showing scan items and the right displaying the diagnostic marks, which indicate different conditions of the test result.

- -!-: indicates that the scanned system may not support the code reading function, or there is a communication error between the tablet and the control system.
- -?-.: indicates that the vehicle control system has been detected, but the tablet cannot accurately locate it.
- Fault | #: Indicates there is/are detected fault code(s) present; “#” indicates the number of the detected faults.
- Pass | No Fault: Indicates the system has passed the scanning process and no fault has been detected.
- Unknown Status: Indicates the system has not been scanned.
- Not Responded: Indicates the system has not received a response.
- N/A: The system is not selected.
- Unselected System: The system is not selected for testing.
- Selected: The system is selected for testing.
- Not Scanned: Indicates the system has not been scanned.
- No Response: Indicates the system has not received a response.

Table 4-3 Function Buttons

Button	Description
Report	Displays the diagnostic data in the report form.
Add Key (guided)	Enters the guided function of the Add Key .
Immobilizer Learning	Enters the Immobilizer Learning function.
ESC	Returns to the previous screen or exits the IMMO Status Scan.

4.4.1.2 Control Unit

This option allows you to manually locate a required IMMO control system for testing through a series of choices. Simply follow the menu-driven procedure and make proper selection each time. The program will guide you to the IMMO function menu after a few choices you have made.

The control unit menu options vary from different vehicles. The function menu may include:

- Immobilizer
- Remote System
- Engine
- IMMO Adaptation

Follow the on-screen instructions to select the correct IMMO part.

Take **Add Key** as an example.

1. Choose **Immobilizer** on the Control Unit screen.

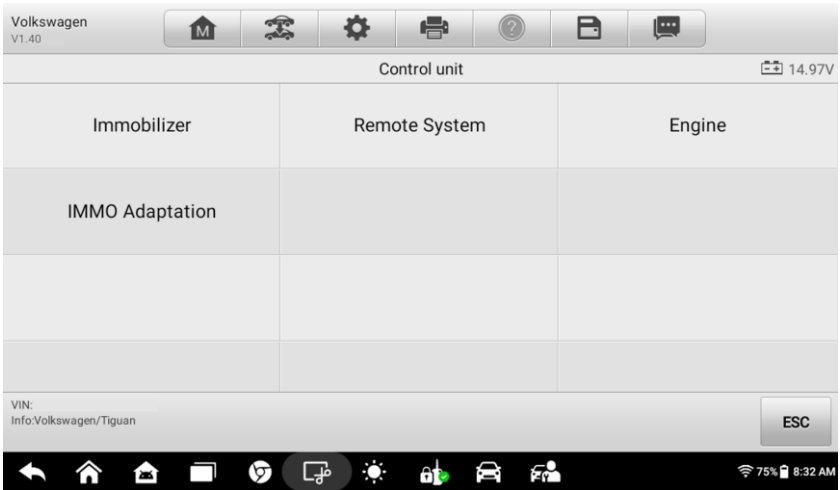

Figure 4-8 Control Unit Screen

2. Tap **Conti CAN Ins (NEC+24C64) - Immobilizer**.



Figure 4-9 Immobilizer Screen

3. Tap **Add Key** on the Instrument Cluster.

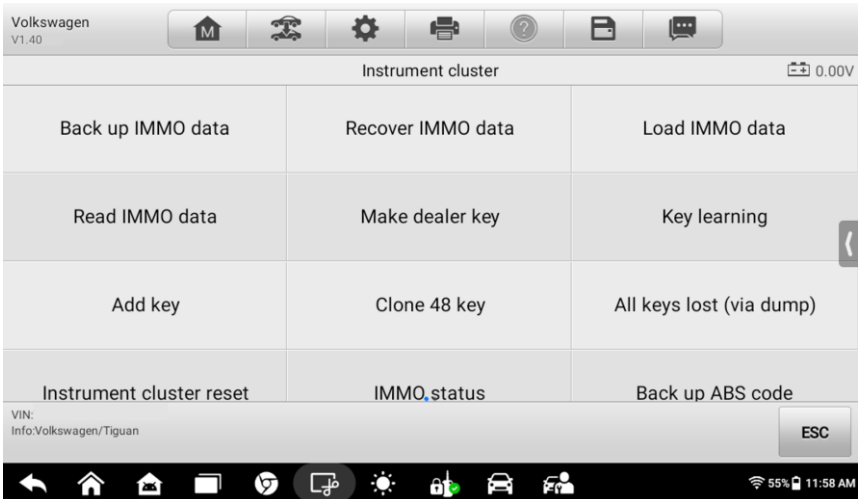

Figure 4-10 Instrument Cluster Screen

4. The following Information screen will display. Tap **Yes** to go on.

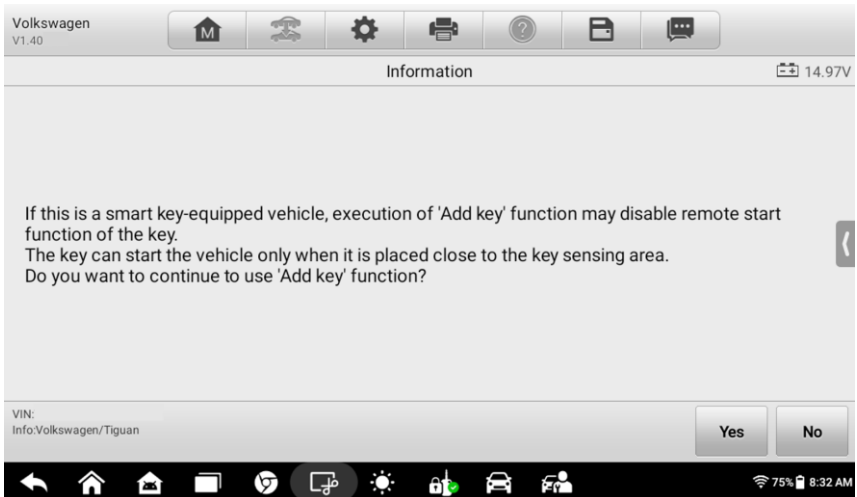

Figure 4-11 Information Screen 1

- A message will appear, reminding you to place the dealer key into the key slot of the programmer. Tap **OK** after the key is placed.

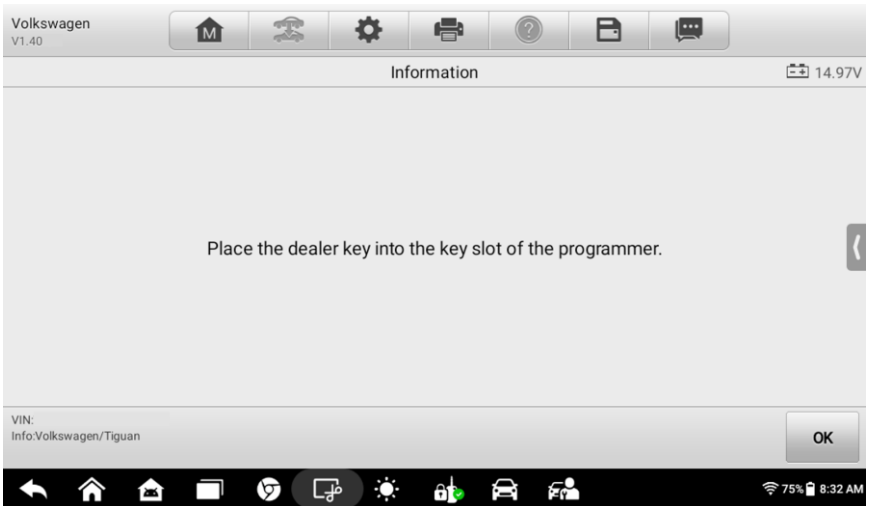

Figure 4-12 Information Screen 2

- The screen will display that “Key added successfully”. Tap **OK** to complete the operation.

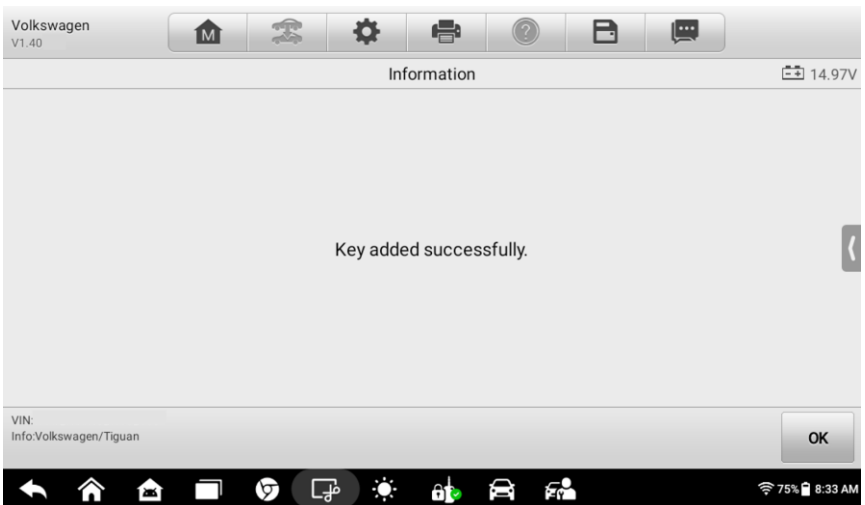

Figure 4-13 Information Screen 3

4.4.1.3 Hot Function

Hot function consists of guided functions with step-by-step instructions. The available functions may vary depending on the test vehicle. The function may include Add Key (guided). Follow the corresponding on-screen instructions to complete the operation.



Figure 4-14 Hot Function Screen

4.4.1.4 Vehicle IMMO Information

This function displays the specific information of the tested vehicle, including key programming information, key information, and OBD position.

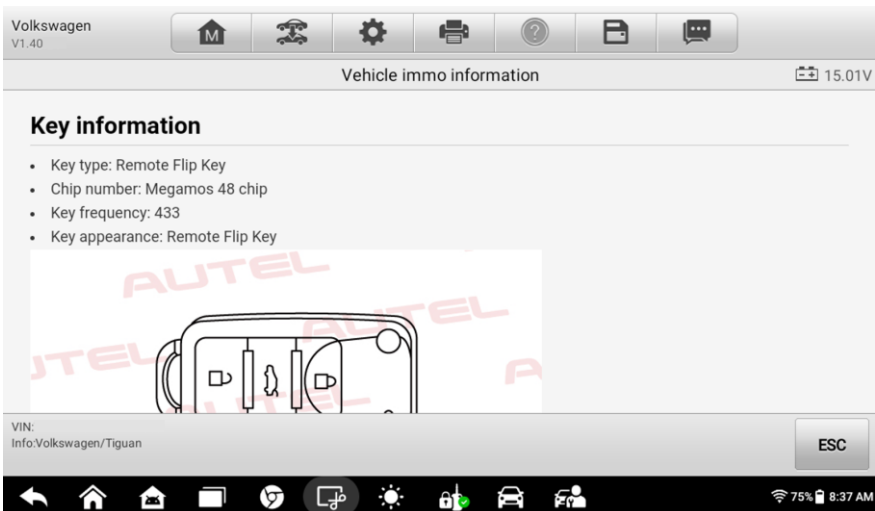

Figure 4-15 Vehicle IMMO Information

4.4.2 Manual Selection

The Manual Selection operation has been described in the Section 4.2.4. After the vehicle information is confirmed, the screen will appear containing [IMMO Status Scan](#), [Control Unit](#), [Hot Function](#) and [Vehicle IMMO Information](#). Click the above links for further details.

4.4.3 System Selection

The System Selection provides direct access to the vehicles' immobilizer systems. The selections may include Immobilizer, Engine, and BSI Clone. Follow the on-screen instructions to complete the operation.

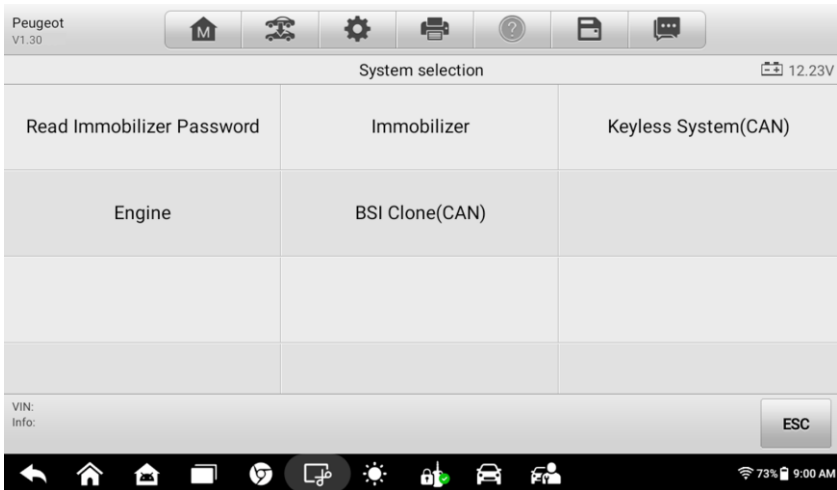

Figure 4-16 System Selection Screen

5 Programmer

The Programmer application requires connection between the tablet and the XP200, and no vehicle connection is required. This application can read, retrieve, and write key information, as well as other key related functions after accessing the key chip.

5.1 Operations

Select the vehicle manufacturer in the vehicle menu, and then follow the on-screen instructions to select the instrument information to display the function menu.

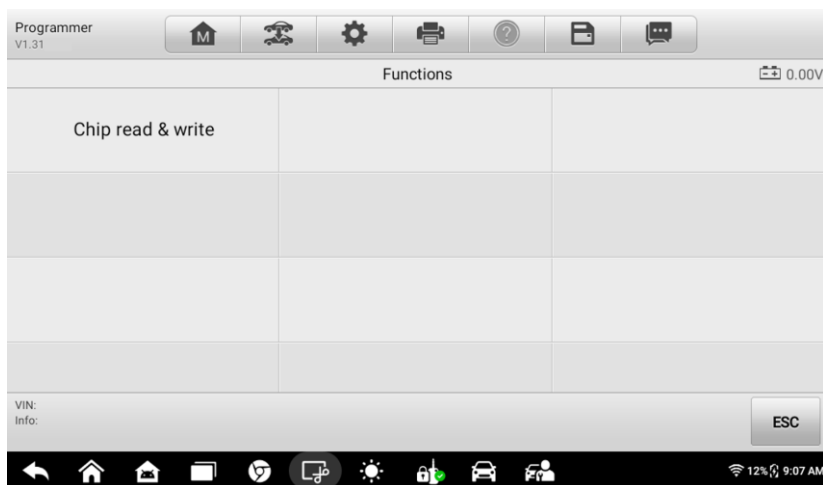

Figure 5-1 Programmer Function Menu

Take **Chip Read & Write** as an example.

1. Select **Chip Read & Write** from the menu.
2. Select the chip type if needed. In this case, **EEPROM** has been selected.



Figure 5-2 Chip Read & Write Screen

3. Select **Read** on the next menu.

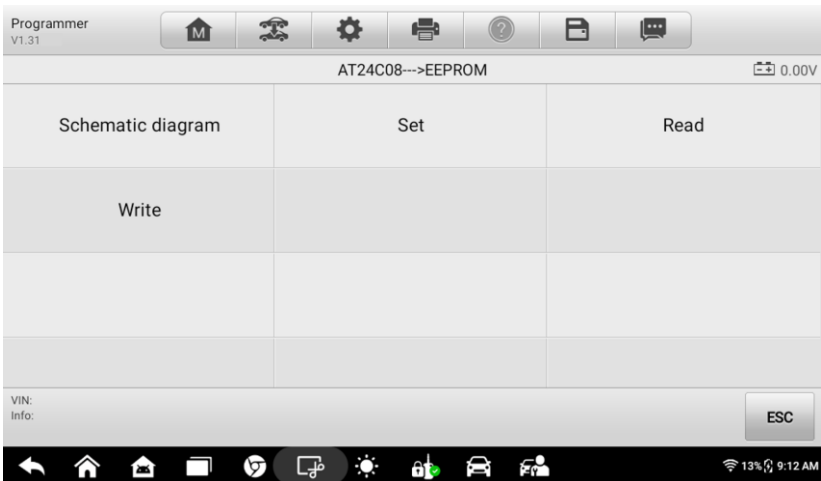

Figure 5-3 Operations Menu

- The Chip Data screen displays. Select **Save** to save the data, or select **Cancel** to exit.

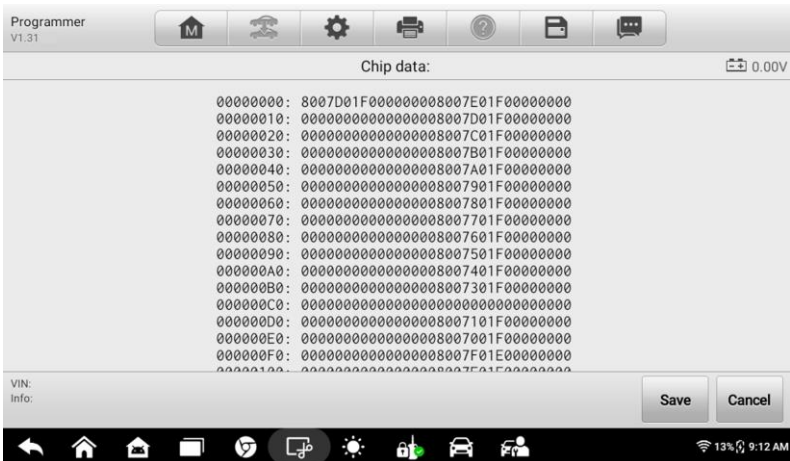

Figure 5-4 Read Operation Screen

- Enter the file name and select **Save** and the chip data will be saved on the tablet. And a “File saved successfully.” Message displays.

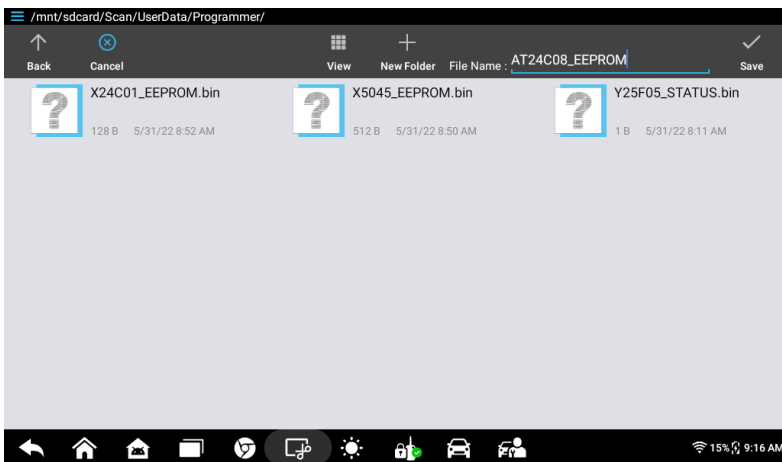

Figure 5-5 Save Data Screen

6. Select **Write** from the operations menu. The tablet will open the default folder, then select the saved data and click **OK** to write it into a black chip.

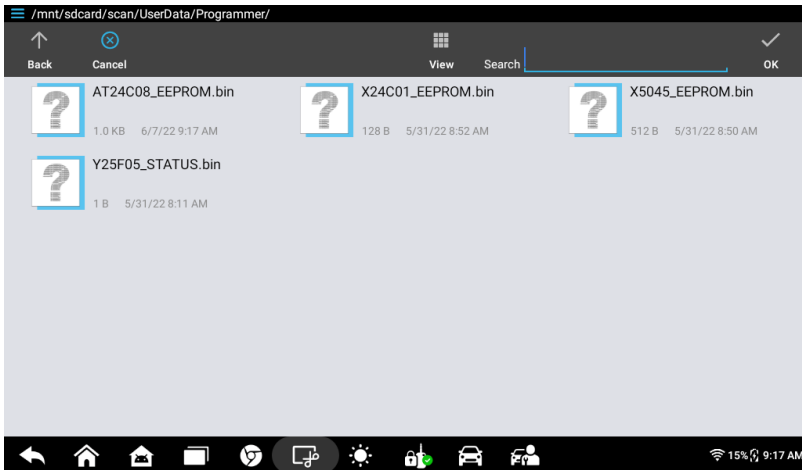

Figure 5-6 Write Operation Screen

6 Diagnostics

The Diagnostics application can retrieve electronic control unit (ECU) information, read & erase DTCs, and view live data. The Diagnostics application can access the electronic control unit (ECU) for various vehicle control systems, including engine, transmission, antilock brake system (ABS), and airbag system (SRS).

6.1 Diagnosis

The Diagnostics application enables a data link to the electronic control system of the test vehicle for vehicle diagnosis via OBDII connection. The application performs function tests, and retrieves vehicle diagnostic information such as trouble and event codes and live data for various vehicle control systems.

There are two options available when accessing the Diagnosis section:

1. Auto Scan — starts auto scanning for all the available systems on the vehicle.
2. Control Unit — displays a selection menu of all the available control units of the test vehicle.

After a section is made and the tablet establishes communication with the vehicle, the corresponding function menu or selection menu displays.

6.1.1 Auto Scan

The Auto Scan function performs a comprehensive scanning over all the ECUs in the vehicle to locate systems' faults and retrieve DTCs. An example of the Auto Scan interface is pictured below:

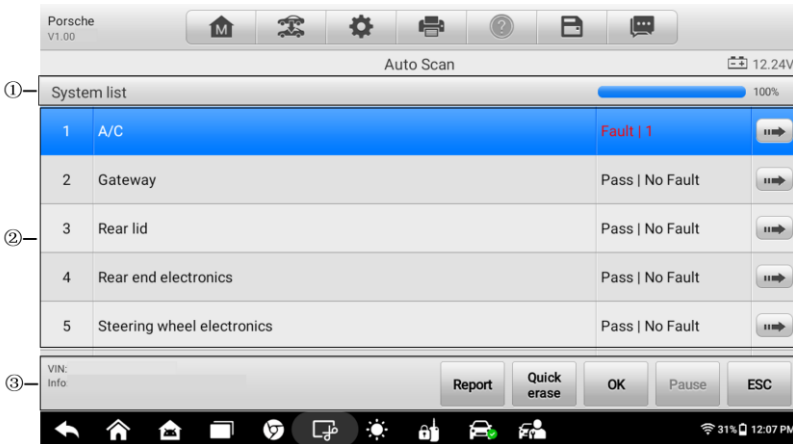

Figure 6-1 Sample Auto Scan Operation Screen

1. Status Bar
2. Main Section
3. Function Buttons

6.1.1.1 Status Bar

List Tab — displays the scanned data in list format.

Progress Bar — indicates the scanning progress.

6.1.1.2 Main Section

Column 1 — displays the sequence numbers.

Column 2 — displays the scanned systems.

Column 3 — displays the diagnostic indicators describing test results.

These indicators are defined as follows:

- ❖ **-!-**: Indicates that the scanned system may not support the code reading function, or there is a communication error between the Tablet and the control system.
- ❖ **-?-**: Indicates that the vehicle control system has been detected, but the Tablet cannot accurately locate it.
- ❖ **Fault(s) | #**: Fault(s) indicates there is/are detected fault code(s) present; “#”

indicates the number of the detected faults.

- ❖ **Pass | No Fault:** Indicates the system has passed the scanning process and no fault has been detected.

Column 4 — to perform further diagnosis or testing on a specific system item, tap the  button to the right of that item. A Function Menu screen will display.

6.1.1.3 Function Buttons

A brief description of the operations of the Auto Scan's Function Buttons are displayed in the table below.

Table 6-1 Function Buttons in Auto Scan

Name	Description
Report	Displays the diagnostic data in the report form.
Quick Erase	Deletes codes. A warning message will display to inform you of possible data loss when this function is selected.
OK	Confirms the test result. Continue the system diagnosis after the required system is selected by tapping the item in the Main Section.
Pause	Suspends scanning and will change to Continue button after tapping.
ESC	Returns to the previous screen or exits Auto Scan.

6.1.2 Control Unit

Manually locate a required control system for testing through a series of choices. Follow the menu driven procedures and make proper selection; the application guides the user to the proper diagnostic function menu based on selections.

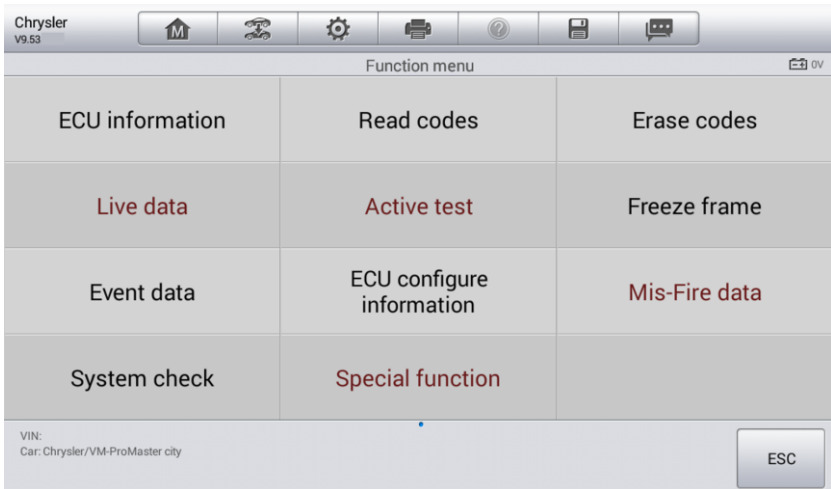

Figure 6-2 Function Menu

The Function Menu options vary slightly from different vehicles. The function menu may include:

- **ECU Information** — provides the retrieved ECU information in detail. An information screen opens upon selection.
- **Read Codes** — displays detailed information of DTC records retrieved from the test vehicle's ECU.
- **Erase Codes** — erases DTC records and other data from the test vehicle's ECU.
- **Live Data** — retrieves and displays live data and parameters from the test vehicle's ECU.
- **Active Test** — accesses specific subsystem and components tests of vehicles.
- **Special Function** — performs various component adaptations.

NOTE

Toolbar functions such as saving and printing of test results can be performed throughout diagnostic testing. Data logging and access to help information are also available.

➤ **To perform a diagnostic function**

1. Establish communication with the test vehicle.
2. Identify the test vehicle by selecting from the menu options.
3. Select the **Diagnosis** section.
4. Locate the required system for testing by **Auto Scan** or through menu driven selections on **Control Unit** screen.

5. Select the desired diagnostic function on the **Function Menu** screen.

6.1.2.1 ECU Information

This function retrieves and displays the specific information for the tested control unit, including unit type, version numbers, and other specifications.

The sample ECU Information screen displays as below:

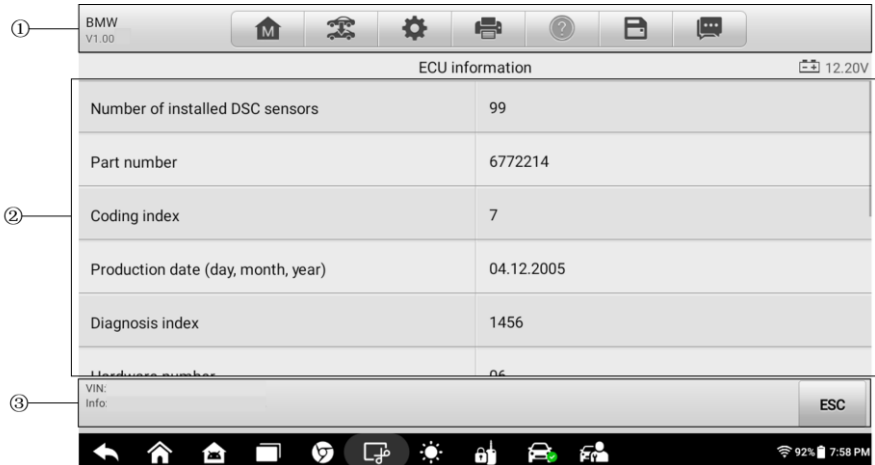

Figure 6-3 ECU Information Screen

1. Diagnostics Toolbar Buttons — see [Table 4-2 Operation Toolbar Buttons](#) for detailed descriptions of the operations for each button.
2. Main Section — the left column displays the item names; the right column displays the specifications or descriptions.
3. Function Button — **ESC** (or **Back**) button is available; tap it to exit after viewing.

6.1.2.2 Read Codes

This function retrieves and displays the DTCs from the vehicle's control system. The Read Codes screen varies from each vehicle being tested. On some vehicles, freeze frame data can also be retrieved for viewing. The sample Read Codes screen displays as below:

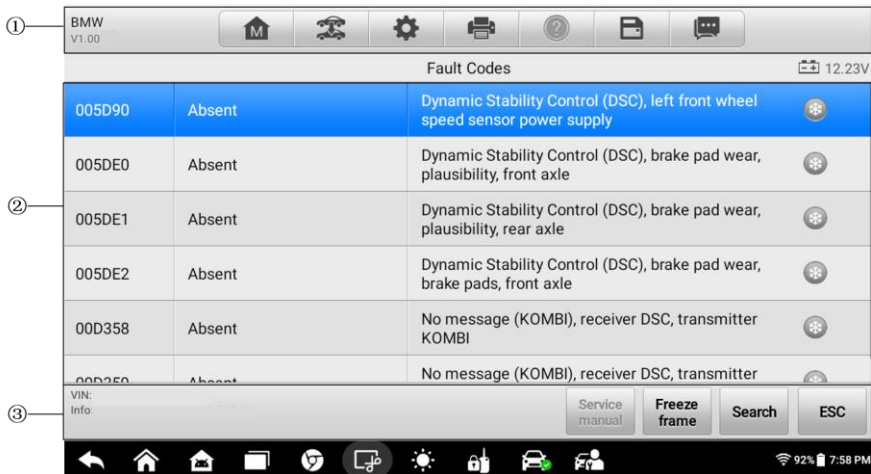

Figure 6-4 Read Codes Screen

1. Diagnostics Toolbar Buttons — see [Table 4-2 Operation Toolbar Buttons](#) for detailed descriptions of the operations for each button.
2. Main Section
 - Code Column — displays the retrieved codes from the vehicle.
 - Status Column — indicates the status of the retrieved codes.
 - Description Column — detailed descriptions for the retrieved codes.
 - Snowflake Icon — only displays when freeze frame data is available for viewing; selecting this icon will display a data screen, which looks and behaves similar to the Read Codes screen.
3. Function Button
 - Service manual — tap it to view fault code information, including fault description, condition for fault identification, and driver information.
 - Freeze frame — tap it to view the freeze frame data of the selected DTC.
 - Search — tap it to search related fault code information on the Internet.
 - ESC — tap it to return to the previous screen or exit the function.

6.1.2.3 Erase Codes

After reading the retrieved codes and making appropriate vehicle repairs, use this function to erase vehicle codes.

➤ To erase codes

1. Tap **Erase Codes** on the Function Menu.
2. A warning message displays to advice of data loss if this function is completed.
 - a) Tap **Yes** to continue. A confirmation screen displays when the operation is successfully done.
 - b) Tap **No** to exit.
3. Tap **ESC** on the confirming screen to exit **Erase Codes**.
4. Perform the **Read Codes** function again to check if codes have been erased successfully.

6.1.2.4 Live Data

When this function is selected, the screen displays the data list for the selected module. The data available for any control module varies from one vehicle to another. The parameters display in the order that they are transmitted by the ECM, so expect variation among vehicles.

Gesture scrolling allows for quick movement through the data list. Touch the screen and drag your finger up or down to reposition the parameters being displayed if the data populates more than one screen. The figure below displays a typical Live Data screen.

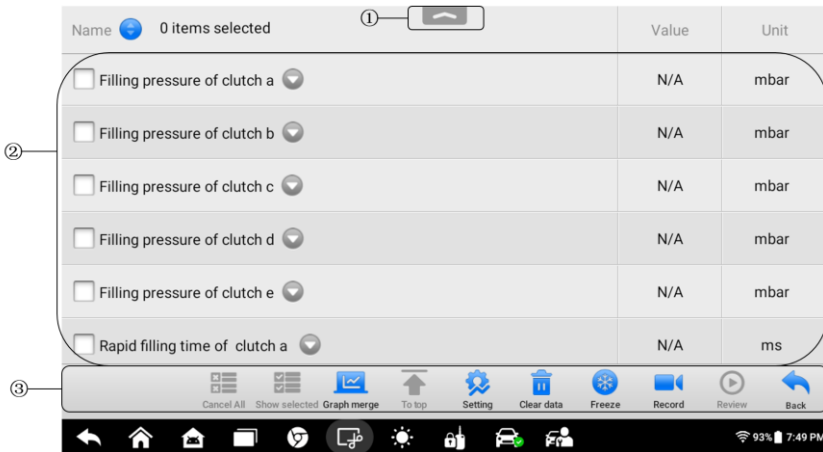

Figure 6-5 Live Data Screen

1. Diagnostics Toolbar Buttons — tap the drop-down button at the top center of the screen and the toolbar buttons will display. See [Table 4-2 Operation Toolbar Buttons](#) for detailed descriptions of the operations for each button.
2. Main Section
 - Name Column — displays the parameter names.
 - a) Check Box — tap the check box on the left side of a parameter to make item selection. Tap the check box again to deselect the item.
 - b) Drop-down Button — tap to open a sub menu.
 - Value Column — displays the values of the parameters.
 - Range Column — displays the ranges of the parameters.
 - Unit Column — displays the units for the parameters.
 - To change the unit mode, tap the **Setting** button on the top toolbar and select a required mode. See [Unit](#) for more information.

Display Mode

There are four types of display modes available for data viewing. Select the proper mode for the diagnostic purpose.

Tap the drop-down button on the right side of a parameter to open a sub menu. A total of 7 buttons will be displayed: The 4 buttons on the left represent different data display modes, plus one **Information** button, highlighted when additional information is available, and one **Unit Change** button, for switching the unit of displayed data, and one **Trigger** button, which opens the "trigger settings" window when tapping.

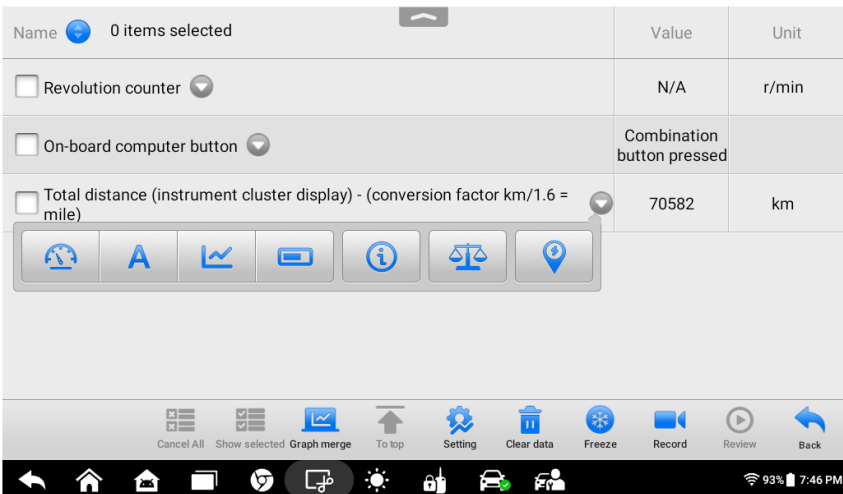

Figure 6-6 Display Mode Screen

Each parameter displays the selected mode independently. The left four buttons are described in sequence below:

- 1) Analog Gauge Mode — displays the parameters in form of an analog meter graph.
- 2) Text Mode — the default mode which displays the parameters in texts and shows in list format.

NOTE

Status parameters, such as a switch reading, can primarily be viewed in text form such as ON, OFF, ACTIVE, and ABORT. Whereas, value parameters, such as a sensor reading, can be displayed in text mode and graph modes.

- 3) Waveform Graph Mode — displays the parameters in waveform graphs.

When this mode is selected, five control buttons display on the right side of the parameter, allowing you to manipulate the display status.

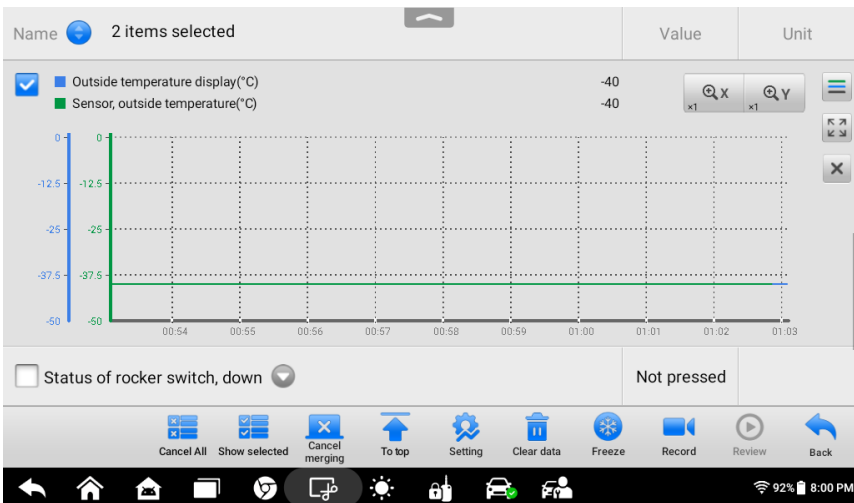

Figure 6-7 Waveform Graph Mode Screen

- **Settings Button (SetY)** — sets the minimum and maximum value of the Y axis.
- **Scale Button** — changes the scale values that are displayed below the waveform graph. There are four scales available: x1, x2, x4 and x8.
- **Edit Button** — edits the waveform color and the line thickness.
- **Zoom-in Button** — tap once to display the selected data graph in full screen.
- **Exit Button** — tap to exit the waveform graph mode.

Full Screen Display — this option is only available in the waveform graph mode, and primarily used in Graph Merge status for data comparison. There are four control buttons available on the top-right side of the screen under this mode.

- ❖ **Scale** Button — tap to change the scale values, which are displayed below the waveform graph. There are four scales available: x1, x2, x4 and x8.
- ❖ **Edit** Button — tap to open an edit window, in which you can set the waveform color and the line thickness displayed for the selected parameter item.
- ❖ **Zoom-out** Button — tap to exit full screen display.
- ❖ **Exit** Button — tap to exit the waveform graph mode.

➤ **To edit the waveform color and line thickness in a data graph**

1. Select parameters to display in Waveform Graph mode.
2. Tap the **Edit** Button and an edit window opens.
3. The parameter item is selected automatically in the left column.
4. Select a color from the middle column.
5. Select a line thickness from the right column.
6. Tap **Done** to save the settings and exit, or tap **Cancel** to exit without saving.
- 4) Digital Gauge Mode — displays the parameters in form of a digital gauge graph.

Trigger Settings

On the trigger setting screen, you can set a standard range by filling in a minimum value and a maximum value. When exceeding this range, the trigger function will be executed and the device will automatically record and save the generated data. You can check the saved live data by tapping the **Review** button at the bottom of the screen.

Tap the drop-down button on the right side of a parameter to open a submenu. The **Trigger** button is the last one in the submenu. Tap to display the “Trigger Settings” window.

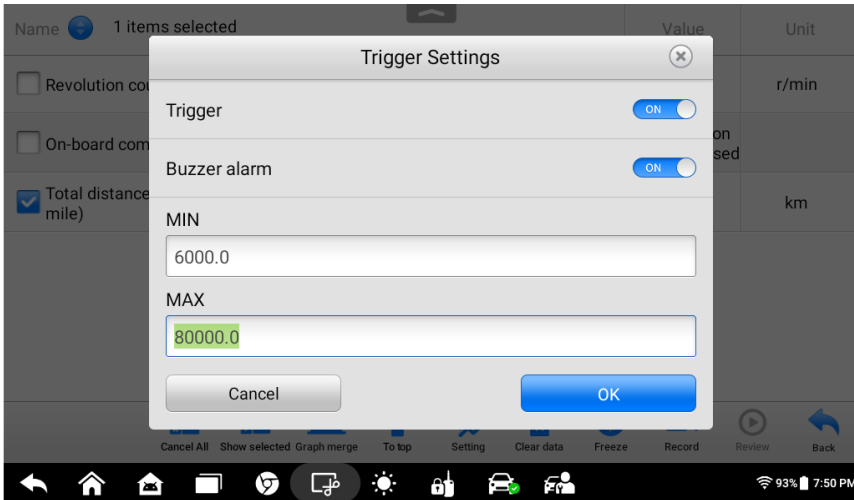

Figure 6-8 Trigger Settings Screen

Two buttons and two input boxes are available in the Trigger Setting window.

- a) **Trigger** — switches the trigger on and off. The trigger is **On** by default.
- b) **Buzzer Alarm** — switches the alarm on and off. The alarm function makes a beep sound as an alert when the data reading reaches the preset minimum or maximum point. The buzzer alarm will only sound at the first trigger.
- c) **MIN** — tap this input box to display a virtual keyboard to enter the required lower limit value.
- d) **MAX** — tap this input box to display a virtual keyboard to enter the required upper limit value.

When the trigger is successfully set, a trigger mark displays in front of the parameter. The mark disappears when it is not triggered, and displays when triggered. Moreover, two horizontal lines display on each of the data graphs (when Waveform Graph Mode is applied) to indicate the alarm point. The limit lines are shown in different colors to differentiate them from the parameter waveforms.

3. Function Buttons

The operations of available function buttons on the Live Data screen are described below:

Cancel All — tap this button to cancel all selected parameter items. Up to 50 parameters can be selected at one time.

Show Selected/Show All — tap this button to switch between the two options; one displays the selected parameters, the other displays all the available items.

Graph Merge — tap this button to merge selected data graphs (for Waveform Graph Mode only). This function is useful when comparing between different parameters.

 **NOTE**

In this mode, Graph Merge supports 2 to 5 parameters when merging.

➤ **To merge selected data graphs**

- 1) Select parameters to be merged.
- 2) Tap the **Graph Merge** button at the bottom of the Live Data Screen.
 - a) This mode only supports parameters that can be represented digitally. If non-digital parameters are selected, a message will display advising the user that the selected parameters are not supported in this mode and to select 2 to 5 digital parameters. Tap the **Got It** button to return to the previous screen and select supported parameters.
 - b) If parameters are selected that are not supported in this mode, a message will display advising the user to select parameters that are supported. A message will also display if more than 5 parameters have been selected. Please select 2 to 5 of the supported parameters and tap the **OK** button to merge.
- 3) Tap the **Cancel Merging** button at the bottom of the Live Data screen to cancel merging.

To Top — moves a selected data item to the top of the list.

Setting — tap button to set recording duration. Eleven options are available: 5 seconds, 15 seconds, 30 seconds, 60 seconds, 90 seconds, 3 minutes, 5 minutes, 10 minutes, 20 minutes, 30,minutes, and 60 minutes.

➤ **To set live data recording duration**

1. Tap the **Setting** button at the bottom of the Live Data screen.
2. Tap the > button to the right of **Recording time after trigger** bar and select a time length.
3. Tap **OK** to save the setting and return to the Live Data Setting screen, or tap the X button at the upper-right corner to exit without saving.
4. Tap **Done** at the upper-right corner of the Live Data Setting screen to confirm and save the setting, and return to the Live Data screen, or tap **Cancel** to exit without saving.

Clear Data — tap this button to clear all cached live data.

Freeze — displays the retrieved data in freeze mode.

- Previous Frame — moves to the previous frame of frozen data.
- Next Frame — moves to the next frame of frozen data.
- Play/Pause — tap to play/pause the frozen data.
- Resume — tap to exit the freeze data mode and return to normal data display.

Record —starts recording the live data of the selected data items. Tap the **Record** button at the bottom of the Live Data screen. A message will display prompting user to select parameters to record. Tap **Got It** button to confirm. Scroll down and select data to record. Tap the **Record** button to start recording. Tap **Resume** button to stop recording. The recorded live data can be viewed in the **Review** section at the bottom of the Live Data screen. The recorded data can also be reviewed in the Data Manager application.

- Resume — tap to stop data recording and to return to normal data display.
- Flag — displays when the Record function is applied. Tap this button to set flags to note points of interest when recording data. Notes can be added during playback in Review or *Data Manager*. Select the preset flag to open a popup window and display a virtual keyboard to input notes.

Review — reviews the recorded data. Tap the **Review** button to display a recording list and select one item to review.

 **NOTE**

Only the data recorded during the current operation can be reviewed on the Live Data screen. All the historical recorded data can be reviewed in "Review Data" in the Data Manager application.

- Previous Frame — switches to the previous frame of recorded data.
- Next Frame — switches to the next frame of recorded data.
- Play/Pause — tap to play/pause the recorded data.
- Show Selected — displays the selected parameters.
- Graph Merge — merges selected data graphs.
- Back — exits the review, and return to the Live Data screen.

Back — returns to previous screen or exits the function.

6.1.2.5 *Active Test*

The Active Test function is used to access vehicle-specific subsystem and component tests. Available tests vary depending on the manufacturer, year, and model, and only the available tests display in the menu.

During an active test, the tester outputs commands to the ECU in order to drive the actuators. This test determines the integrity of the system or parts by reading the engine ECU data, or by monitoring the operation of the actuators, such as switching a solenoid, relay, or switch, between two operating states.

Selecting **Active Test** opens a menu of test options that varies by make and model. Selecting a menu option activates the test. Follow all screen instructions while performing tests. The content and pattern of the on-screen information vary according to the type of test being performed. Some toggle and variable control tests display Active Test Controls at the top of the screen with data stream information below, or vice versa.

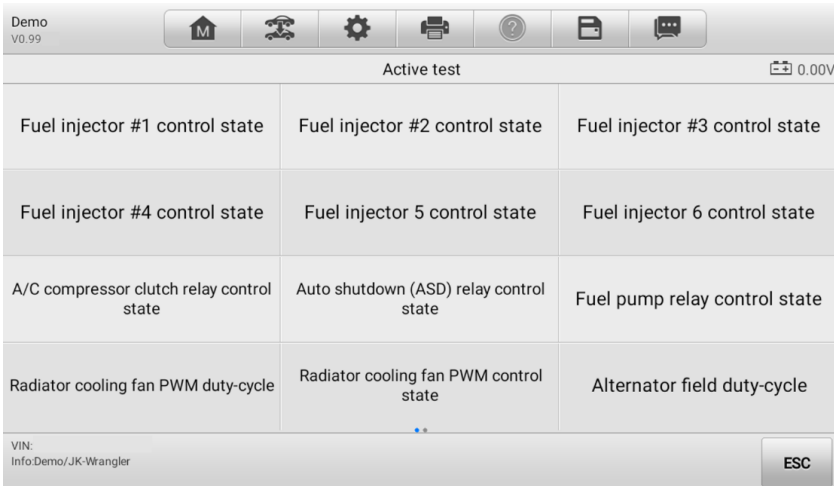

Figure 6-9 Active Test Screen

The function buttons at the lower right corner of the Active Test screen manipulate the test signals. The operational instructions are displayed on the main section of the test screen. Simply follow the on-screen instructions and make appropriate selections to complete the tests. Each time when an operation is successfully executed, message such as “Command Finished”, “Activation Successful”, or something similar displays.

Tap the **ESC** function button to exit the test when finished.

6.1.2.6 Special Function

These functions perform various component adaptations, allowing you to recalibrate or configure certain components after making repairs or replacement.

The main section of the Adaptation Operation screen displays a list of operational and vehicle status information, which mainly consists of four parts:

1. The first part in the top line shows the description of the operation being performed,

and the execution status is displayed on the right, such as Completed, Activated, etc.

2. The second part shows the preconditions or requirements for executing the operation being selected.
3. The third part displays the current conditions of the vehicle control module being learned for comparison to the preconditions suggested by the second part. If the current condition of the control module is out of the suggested limit value, you must adjust the vehicle condition to meet the requirement.
4. The last part displays the instruction of how to use the function button at the lower right corner of the screen to manipulate the teach-in operations.

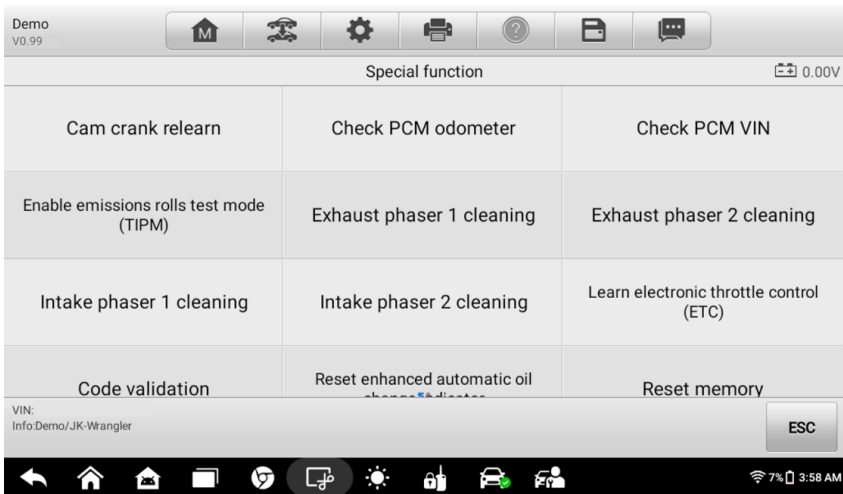

Figure 6-10 Special Function Screen

Read the information carefully and check the vehicle condition accordingly, when you are sure that the vehicle is ready to perform the adaptation, simply follow the instruction provided to make appropriate selections. When the operation is done, an execution status message such as Completed, Finished or Successful, displays.

Tap the **ESC** button to exit the function.

6.2 Generic OBDII Operations

A fast-access option for OBDII/EODB vehicle diagnosis is available on the Vehicle Menu screen. This option presents a quick way to check for DTCs, isolate the cause of an illuminated malfunction indicator lamp (MIL), check monitor status prior to emissions certification testing, verify repairs, and perform a number of other emissions-related services. The OBD direct access option is also used for testing OBDII/EODB compliant vehicles that are not included in the Diagnostics database.

Functions of the diagnostics toolbar buttons at the top of the screen are the same as those available for specific vehicle diagnostics. See [Table 4-2 Operation Toolbar Buttons](#) for details.

6.2.1 General Procedure

➤ To access the OBDII/EOBD diagnostics functions

1. Tap the **Diagnostics** application button on the MaxiIM Job Menu. The Vehicle Menu displays.
2. Tap the **EOBD** button. There are two options to establish communication with the vehicle.
 - **Auto Scan** — when this option is selected, the diagnostic tool attempts to establish communication using each protocol in order to determine which one the vehicle is broadcasting on.
 - **Protocols** — when this option is selected, the screen opens a submenu of various protocols. A communication protocol is a standardized way of data communication between an ECM and a diagnostic tool. Global OBD may use several different communication protocols.
3. Select a specific protocol under the **Protocols** option. Wait for the OBDII Diagnostics Menu to appear.

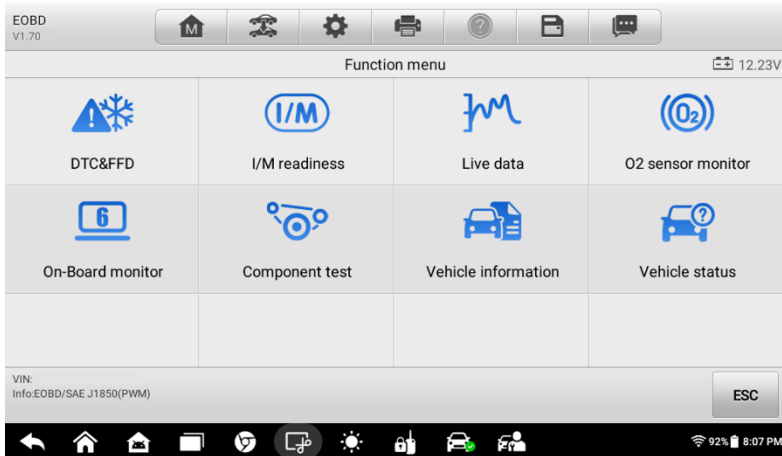

Figure 6-11 OBDII Diagnostics Menu Screen

4. Select a function option to continue.
 - **DTC & FFD**
 - **I/M Readiness**
 - **Live Data**

- **O₂ Sensor Monitor**
- **On-Board Monitor**
- **Component Test**
- **Vehicle Information**
- **Vehicle Status**

NOTE

Some functions are supported only on certain vehicles.

6.2.2 Function Descriptions

This section describes the various functions of each diagnostic option:

6.2.2.1 DTC & FFD

When this function is selected, the screen displays a list of Stored Codes and Pending Codes. When the Freeze Frame data of certain DTCs are available for viewing, a snowflake button will display on the right side of the DTC item.

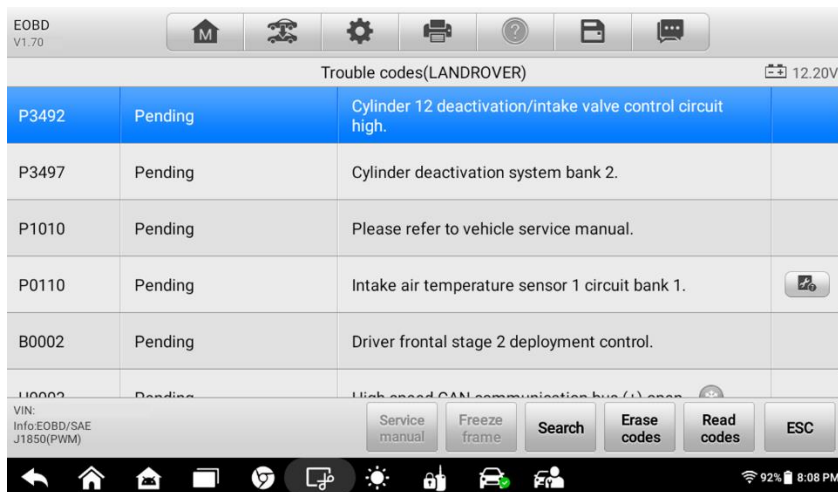

Figure 6-12 DTC & FFD Screen

The Erase codes and Read codes function can be applied by tapping the function buttons at the bottom of the screen.

- **Stored Codes**

Stored codes are the current emissions-related DTCs from the ECM of the vehicle. OBDII/EOBD Codes have a priority according to their emission severity, with higher priority codes overwriting lower priority codes. The priority of the code determines

the illumination of the Malfunction Indicator Light (MIL) and the codes erase procedure. Manufacturers rank codes differently, so expect to see differences between vehicles.

- **Pending Codes**

These are codes whose setting conditions were met during the last drive cycle, but need to be met on two or more consecutive drive cycles before the DTC actually sets. The intended use of this service is to assist the service technician after a vehicle repair and after clearing diagnostics information, by reporting test results after a driving cycle.

- a) If a test fails during the driving cycle, the DTC associated is reported. If the pending fault does not occur again within 40 to 80 warm-up cycles, the fault is automatically cleared from memory.
- b) Test results reported by this service do not necessarily indicate a faulty component or system. If test results indicate another failure after additional driving, then a DTC is set to indicate a faulty component or system, and the MIL is illuminated.

- **Freeze Frame**

In most cases the stored frame is the last DTC reported. Certain DTCs, which have a greater impact on vehicle emission, have a higher priority. In these cases, the top prioritized DTC is the one for which the freeze frame records are retained. Freeze frame data includes a “snapshot” of critical parameter values at the time the DTC is set.

- **Erase Codes**

This option is used to clear all emissions-related diagnostics data such as DTCs, freeze frame data, and specific manufacturer-enhanced data from the vehicle's ECM.

A confirmation screen displays when the clear codes option is selected to prevent accidental loss of data. Select **Yes** on the confirmation screen to continue or **No** to exit.

6.2.2.2 *I/M Readiness*

This function is used to check the readiness of the monitoring system. It is an excellent function to use prior to having a vehicle inspected for compliance to a state emissions program. Selecting **I/M Readiness** opens a submenu with two choices:

- **Since DTCs Cleared** — displays the status of monitors since the last time the DTCs are erased.
- **This Driving Cycle** — displays the status of monitors since the beginning of the current drive cycle.

6.2.2.3 *Live Data*

This function displays the real time PID data from ECU. Displayed data includes analog inputs and outputs, digital inputs and outputs, and system status information broadcast on the vehicle data stream.

Live data can be displayed in various modes. See [Live Data](#) for detailed information.

6.2.2.4 *O₂ Sensor Monitor*

This option allows retrieval and viewing of O₂ sensor monitor test results for the most recently performed tests from the vehicle's on-board computer.

The O₂ Sensor Monitor test function is not supported by vehicles that communicate using a controller area network (CAN). For O₂ Sensor Monitor tests results of CAN-equipped vehicles, refer to [On-Board Monitor](#).

6.2.2.5 *On-Board Monitor*

This option allows you to view the results of On-Board Monitor tests. The tests are useful after the service when a vehicle's control module memory is already erased.

6.2.2.6 *Component Test*

This service enables bi-directional control of the ECM so that the diagnostics tool is able to transmit control commands to operate the vehicle systems. This function is useful in determining whether the ECM responds to a command well.

6.2.2.7 *Vehicle Information*

The option displays the vehicle identification number (VIN), the calibration identification, and the calibration verification number (CVN), and other information of the test vehicle.

6.2.2.8 *Vehicle Status*

This item is used to check the current condition of the vehicle, including communication protocols of OBDII modules, retrieved codes amount, status of the Malfunction Indicator Light (MIL), and other additional information.

6.3 **Exiting Diagnostics**

The Diagnostics application remains open as long as there is an active communication with the vehicle. You must exit the diagnostics operation to stop all communications with the vehicle before closing the Diagnostics application.

 **NOTE**

Damage to the vehicle electronic control module (ECM) may occur if communication is disrupted. Make sure all connections, such as USB cable and wireless connection, are properly connected at all times during testing. Exit all tests before disconnecting the test cable or powering down the tablet.

➤ **To exit the Diagnostics application**

1. On an active diagnostics screen, tap the **Back** or **ESC** button to exit a diagnostics session step-by-step.
2. Or tap the **Vehicle Swap** button on the diagnostics toolbar to return to the Vehicle Menu screen.
3. On the Vehicle Menu screen, tap the **Home** button on the top toolbar; or tap the **Back** button on the navigation bar at the bottom of the screen.
4. Or tap the **Home** button on the diagnostics toolbar to exit the application directly and go back to the MaxiIM Job Menu.

Now, the Diagnostics application is no longer communicating with the vehicle and it is safe to open other MaxiIM applications, or exit the MaxiIM Diagnostics System and return to the Android System's Home screen.

7 Service

The Service section is specially designed to provide you with quick access to the vehicle systems for various scheduled service and maintenance performances. The typical service operation screen is a series of menu driven executive commands. By following the on-screen instructions to select appropriate execution options, enter correct values or data, and perform necessary actions, the system will guide you through the complete performance for various service operations.

The most commonly performed service functions include:

- Oil Reset Service
- EPB Service
- BMS Service
- SAS Service
- DPF Service
- TPMS Service

After entering each special function, the displayed screen consists of two applications: **Diagnosis** and **Hot Functions**. The **Diagnosis** is for you to read/clear data since this is necessary after some special functions. **Hot Functions** consists of sub functions of the selected special function.

7.1 Oil Reset

This function allows you to perform reset for the Engine Oil Life system, which calculates an optimal oil life change interval depending on the vehicle driving conditions and climate. The Oil Life Reminder must be reset every time the oil is changed, so the system can calculate when the next oil change is required.

IMPORTANT

Always reset the engine oil life to 100% after every oil change.

NOTE

1. All required work must be carried out before the service indicators are reset. Failure to do so may result in incorrect service values and cause DTCs to be stored by the relevant control module.
2. For some vehicles, the scan tool can perform added functionality to reset additional

service lights (maintenance cycle, service interval). Taking BMW as an example, its service reset function includes engine oil, spark plugs, front/rear brakes, coolant, particle filter, brake fluid, micro filter, vehicle inspection, exhaust emission inspection and vehicle check.

7.2 Electronic Parking Brake (EPB)

This function has a multitude of usages to maintain the electronic braking system safely and effectively. The applications include deactivating and activating the brake control system, assisting with brake fluid control, opening and closing brake pads, and setting brakes after disc or pad replacement, etc.

7.2.1 EPB Safety

It may be dangerous to perform Electronic Parking Brake (EPB) system maintenance, so before you begin the service work, please keep these rules in mind.

- ✓ Ensure that you are fully familiar with the braking system and its operation before commencing any work.
- ✓ The EPB control system may be required to be deactivated before carrying out any maintenance/diagnostic work on the brake system. This can be done from the tool menu.
- ✓ Only carry out maintenance work when the vehicle is stationary and on level ground.
- ✓ Ensure that the EPB control system is reactivated after the maintenance work has been completed.

NOTE

Autel accepts no responsibility for any accident or injury arising from the maintenance of the Electronic Parking Brake system.

7.3 BMS

The BMS (Battery Management System) allows the scan tool to evaluate the battery charge state, monitor the close-circuit current, register the battery replacement, and activate the rest state of the vehicle.

NOTE

1. This function is not supported by all vehicles.
 2. The sub functions and actual test screens of the BMS may vary for different test vehicles, please follow the on-screen instructions to make correct option selection.
-

The vehicle may use either a sealed lead-acid battery or an AGM (Absorbed Glass Mat) battery. Lead acid battery contains liquid sulphuric acid and can spill when overturned. AGM battery (known as VRLA battery, valve regulated lead acid) also contains sulphuric acid, but the acid is contained in glass mats between terminal plates.

It is recommended that the replacement aftermarket battery has the same specifications, such as capacity and type, with the battery used in the vehicle. If the original battery is replaced with a different type of battery (e.g. a lead-acid battery is replaced with an AGM battery) or a battery with a different capacity (mAh), the vehicle may require reprogramming the new battery type in addition to performing the battery reset. Consult the vehicle manual for additional vehicle-specific information.

7.4 Steering Angle Sensor (SAS)

Steering Angle Sensor Calibration permanently stores the current steering wheel position as the straight-ahead position in the steering angle sensor EEPROM. Therefore, the front wheels and the steering wheel must be set exactly to the straight-ahead position before calibration. In addition, the vehicle identification number is also read from the instrument cluster and stored permanently in the steering angle sensor EEPROM. On successful completion of calibration, the steering angle sensor fault memory is automatically cleared.

Calibration must always be carried out after the following operations:

- Steering wheel replacement
- Steering angle sensor replacement
- Any maintenance that involves opening the connector hub from the steering angle sensor to the column
- Any maintenance or repair work on the steering linkage, steering gear or other related mechanism
- Wheel alignment or wheel track adjustment
- Accident repairs where damage to the steering angle sensor or assembly, or any part of the steering system may have occurred

NOTE

1. Autel accepts no responsibility for any accident or injury arising from servicing the SAS system. When interpreting DTCs retrieved from the vehicle, always follow the manufacturer's recommendation for repair.
 2. All software screens shown in this manual are examples, actual test screens may vary for each vehicle being tested. Observe the menu titles and on-screen instructions to make correct option selections.
-

3. Before starting the procedure, make sure the vehicle has an ESC button. Look for the button on dash.

7.5 Tire Pressure Monitor System (TPMS)

This function allows you to quickly look up the tire sensor IDs from the vehicle's ECU, as well as to perform TPMS replacement and reset procedures after tire sensors are replaced.

7.6 IMMO Keys

An immobilizer is an anti-theft mechanism that prevents an automobile's engine from starting unless the correct ignition key or other device is present. This device prevents thieves from starting the car by a method known as hot wiring. Most new vehicles have an immobilizer as standard equipment. An important advantage of this system is that it doesn't require the car owner to activate it. It operates automatically. An immobilizer is considered as providing much more effective anti-theft protection than an audible alarm alone. Many auto insurance companies offer lower rates for vehicles that are equipped with an immobilizer.

As an anti-theft device, an immobilizer disables one of the systems needed to start a car's engine, usually the fuel supply or the ignition. This is accomplished by radio frequency identification between a transponder in the ignition key and a device called a radio frequency reader in the steering column. When the key is placed in the ignition, the transponder sends a signal with a unique identification code to the reader, which relays it to a receiver in the vehicle's computer control module. If the code is correct, the computer allows the fuel supply and ignition systems to operate and start the car. If the code is incorrect or absent, the computer disables the system, and the car will be unable to start until the correct key is placed in the ignition.

The IMMO Keys service can disable a lost vehicle key and program the replacement key fob. One or more replacement key fobs can be programmed.

8 Update

The Update application allows you to download the latest released software. The updates can improve the MaxiIM applications' capabilities, typically by adding new tests, new models or enhanced applications to the database.

The Tablet automatically searches for available updates for all of the MaxiIM software when it is connected to the Internet. Any updates that are found can be downloaded and installed on the device. This section describes installing an update to the MaxiIM System.

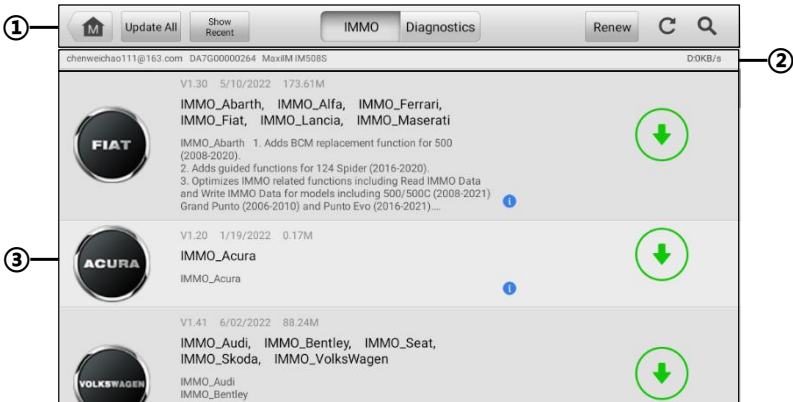

Figure 8-1 Update Screen

1. Navigation and Controls

- Home Button — returns the MaxiIM Job Menu.
- Update All — updates all available update packages.
- Show Recent — shows the recent updates.
- IMMO Tab — displays all the available IMMO software for vehicles.
- Diagnostics Tab — displays all the available vehicle diagnostic software.
- Renew Button — displays expire date of the software. Tap on the **Renew** Button to extend subscription.
- Refresh Button — refreshes the available update list.
- Search Button — search a specific update item by inputting the file name such as a specific vehicle manufacturer.

2. Status Bar

- Left Side — displays user account, MaxiIM device model information, and serial number.
- Right Side — displays the real-time Internet speed amid downloading.

3. Main Section

- Left Column — displays vehicle logos.
- Middle Column — displays a brief introduction about the new changes to the software operation or capabilities. Tap the  button to display an information screen to view more details, and tap the dim area around to close the window.
- Right Column — according to the operation status of each software item, the button displays differently.
 - a) Tap **Update** to update the selected item.
 - b) Tap **Pause** to suspend the updating procedure.
 - c) Tap **Continue** to continue updating the suspended update.

➤ To update the diagnostic software

1. Make sure the Tablet is connected to a power source with stable access to the Internet.
2. Tap the **Update** application button from the MaxiIM Job Menu, or tap the update notification message when received one, or tap the **Update** icon on Vehicle Menu in Diagnostics application. The Update application screen displays.
3. Check all available updates:
 - If you decide to update all the items of IMMO software, select **IMMO** Tab and then tap the **Update All** button; if you want to update all items of diagnostics software, select **Diagnostics** Tab and then tap the **Update All** button.
 - If you only want to update one or some of the item(s), tap the **Update** button on the right of the specific item(s).
4. Tap the **Pause** button to suspend the updating process. Tap **Continue** to resume the update and the process will continue from the pause point.
5. When the updating process is completed, the software will be installed automatically. The new version will replace the older version.

9 Settings

Selecting Settings application opens a setup screen, on which you can adjust default settings and view information about the MaxiIM system. There are nine options available for the MaxiIM system settings:

- **Unit**
- **Language**
- **Printing Settings**
- **Report Settings**
- **Firmware Upgrade**
- **Auto Update**
- **Vehicle List**
- **System Settings**
- **About**

This section describes the operation procedures for the settings.

9.1 Unit

This option allows you to adjust the measurement unit for the diagnostics system.

- **To adjust the unit setting**
 1. Tap the **Settings** application on the MaxiIM Job Menu.
 2. Tap the **Unit** option on the left column.
 3. Select the required measurement unit, Metric or English. A check mark will display to the right of the selected unit.
 4. Tap the **Home** button on the top-left corner to return to the MaxiIM Job Menu, or select another setting option for system setup.

9.2 Language

This option allows you to adjust the display language for the MaxiIM system.

- **To adjust the language setting**
 1. Tap the **Settings** application on the MaxiIM Job Menu.
 2. Tap the **Language** option on the left column.

3. Select the required language. A check mark will display to the right of the selected language.
4. Tap the **Home** button on the top-left corner to return to the MaxiIM Job Menu, or select another setting option for system setup.

9.3 Printing Settings

Printing Setting

This option allows you to print any data or information via a PC.

➤ **To set up the printer connection**

1. Tap the **Settings** application on the MaxiIM Job Menu.
2. Tap the **Printing Settings** option on the left column.
3. Tap the **Print via PC-Link** item to activate the printing function, which enables the device to send files to the printer through the PC via Wi-Fi connection.
4. Tap the **Home** button on the top-left corner to return to the MaxiIM Job Menu. Or select another setting option for system setup.

Printing Operations

➤ **To install the MaxiSys Printer driver program**

1. Download Maxi PC Suite on www.autel.com > **Support** > **Downloads** > **Autel Update Tools**. Select **Maxi PC Suite** and click **Download here** to install the printer to your PC.
2. Double click the **setup.exe** file.
3. Select the installation language and the wizard will load momentarily.
4. Follow the instructions on the screen and click **Next** to continue.
5. Click **install**. The printer driver program will be installed onto the PC.
6. Click **Finish** to complete the installation.

NOTE

The **MaxiSys Printer** runs automatically after the installation. Before printing, make sure the tablet is connected to the same network with the computer, either via Wi-Fi or LAN. And the computer is connected to a printer.

➤ **To perform printing via PC**

1. Run the **PC Link** on the computer.
2. Click **Test Print** to make sure the printer is working successfully.
3. Tap the **Print** button on the toolbar of the Tablet. A test document will be created

and sent to the computer.

- ✧ If the **Auto Print** option in the MaxiSys Printer is selected, the MaxiSys Printer will print the received document automatically.
- ✧ If the **Auto Print** option is not selected, click **Open PDF File** button to view the files. Select the file(s) you want to print and click **Print**.

9.4 Report Settings

This option automatically synchronizes the diagnostics information of the vehicle to the vehicle history and forms a diagnostics report for the user to upload. Tap the **ON/OFF** button to enable/disable the Report Upload to Cloud function. The button appears blue if the function is enabled and is gray if the function is disabled.

NOTE

Make sure the tablet is connected to network while uploading reports.

9.5 Firmware Upgrade

This option allows you to update the firmware of the tool.

Connect the tablet to the vehicle with the supplied main cable and ensure the tablet is connected to the Internet. Follow the on-screen instructions to complete the operation.

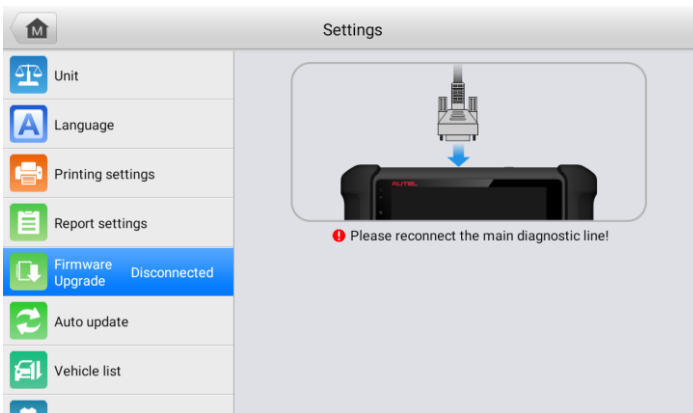

Figure 9-1 Firmware Upgrade Screen

➤ To upgrade the firmware

1. Connect the tablet to the vehicle using the main cable.
2. Tap **Settings** on the MaxiIM Job Menu.
3. Tap **Firmware Upgrade** on the left column.

4. Tap the **Update Now** button to upgrade to the latest firmware version.
5. Tap the **Home** button on the top-left corner to return to the MaxiIM Job Menu, or select another setting option for system setup.

9.6 Auto Update

The Auto Update allows the tablet to automatically update the OS, the MaxiIM system, and the vehicle software. You can switch **ON** by tapping the button on the right side of each item and set the desired automatic update time.

Tap the **ON/OFF** button to enable/disable the Auto Update function. The button displays blue if Auto Update is enabled and displays gray if the Auto Update is disabled. Set the time of the day for updating. If the update time is set, the selected software will be automatically updated at configured time.

NOTE

Internet connection is necessary for auto update, otherwise, it would not work even if you have already switch it on. Make sure the tablet is connected to the Internet for the time you have set.

9.7 Vehicle List

This option allows you to sort the vehicles either by alphabetical order or by frequency of use.

➤ To adjust the vehicle list setting

1. Tap **Settings** on the MaxiIM Job Menu.
2. Tap **Vehicle List** on the left column.
3. Select the desired sort type. A check mark will display to the right of the selected item.
4. Tap the **Home** icon on the top-left corner to return to the MaxiIM Job Menu, or select another setting option for the system setup.

9.8 System Settings

This option provides you with a direct access to the Android background system setting screen, where you can adjust various system settings for the Android system platform, such as networks settings, battery, display, etc.

You may refer to Android documentation for additional information about Android system settings.

9.9 About

The About option provides information of the MaxiIM tablet regarding the product name, version, hardware, and serial number.

➤ **To check the MaxiIM product information in About**

1. Tap the **Settings** application on the MaxiIM Job Menu.
2. Tap the **About** option on the left column. The product information displays on the right.
3. Tap the **Home** button on the top-left corner to return to the MaxiIM Job Menu, or select another setting option for the system setup after viewing.

10 Remote Desktop

The Remote Desktop application launches the TeamViewer Quick Support program, which is a simple, fast, and secure remote control screen. You can use the application to receive ad-hoc remote support from Autel's support center, colleagues, or friends, by allowing them to control your MaxilM tablet on their PC via the TeamViewer software.

If you think of a TeamViewer connection as a phone call, the TeamViewer ID would be the phone number under which all TeamViewer Clients can be reached separately. Computers and mobile devices that run TeamViewer are identified by a globally unique ID. The first time the Remote Desktop application is started, this ID is generated automatically based on the hardware characteristics and will not change.

Make sure the Tablet is connected to the Internet before launching the Remote Desktop application, so that the Tablet is able to receive remote support from a third party.

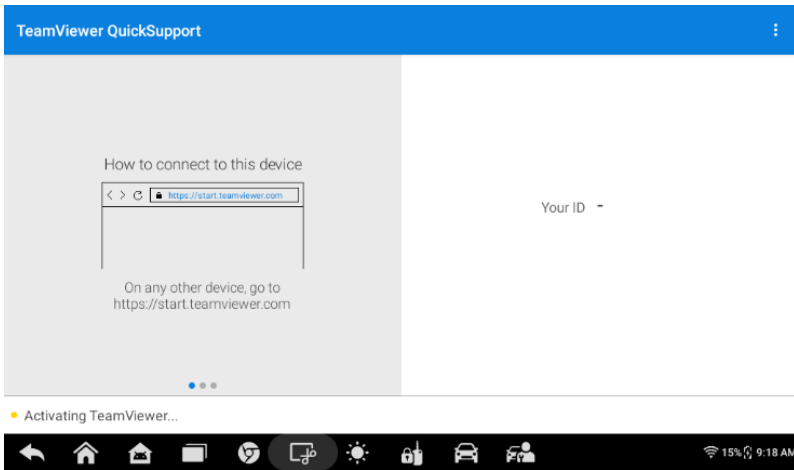

Figure 10-1 Remote Desktop Screen

- **To receive remote support from a partner**
 1. Power on the Tablet.
 2. Tap the **Remote Desktop** application on the MaxilM Job Menu. The TeamViewer QuickSupport screen displays and the device ID is generated and shown.
 3. Your partner must install the Remote Control software to his/her computer by downloading the TeamViewer full version program online

(<http://www.teamviewer.com>). Start the software on his/her computer at the same time, in order to provide support and take control of the Tablet remotely.

4. Provide your ID to the partner, and wait for him/her to send you a remote control request.
5. A message displays to ask for your confirmation to allow remote control on your device.
6. Tap **Allow** to accept, or tap **Deny** to reject.

Refer to the associated TeamViewer documents for additional information.

11 Data Manager

The Data Manager application is used to store, print, and review the saved files. Most operations are controlled through the toolbar.

The table below briefly describes each of the function buttons in the Data Manager application.

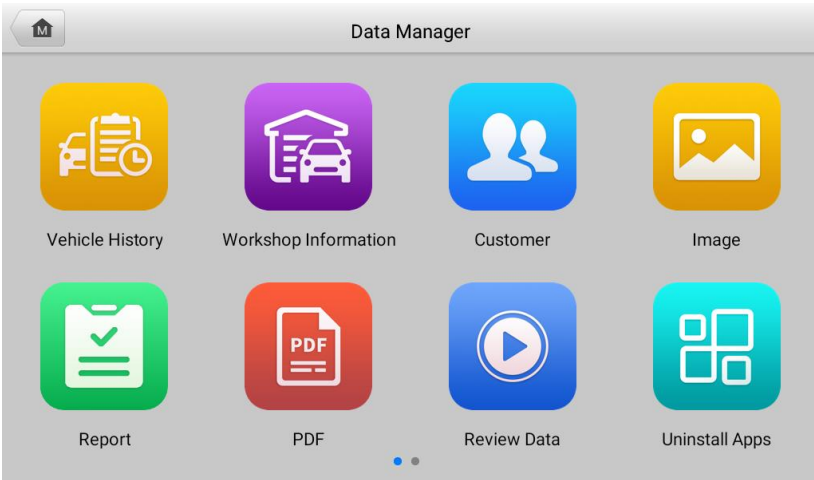











Figure 11-1 Data Manager Main Screen

Table 11-1 Buttons in Data Manager

Button	Name	Description
	Vehicle History	Reviews the diagnostic history record.
	Workshop Information	Edits the information of workshops.
	Customer	Creates a new customer account file.
	Image	Reviews the screenshots.
	Report	Views the local reports on your tablet or scan a QR code to view and share the reports via your smartphone browser.

Button	Name	Description
	PDF	Reviews the diagnostic reports.
	Review Data	Reviews the recorded data.
	Uninstall Apps	Uninstalls applications.
	Data Logging	Reviews the communication data and ECU information of the vehicle. The saved data can be reported and sent to the technical center via the Internet.

11.1 Vehicle History

This function stores records of vehicle history, including vehicle information and the retrieved DTCs from previous diagnostic sessions. Test information is summarized and displayed in an easy-to-read table listing. The Vehicle History also provides direct access to the previously tested vehicle and allows you to directly restart a diagnostic session without needing to perform auto or manual vehicle selection.

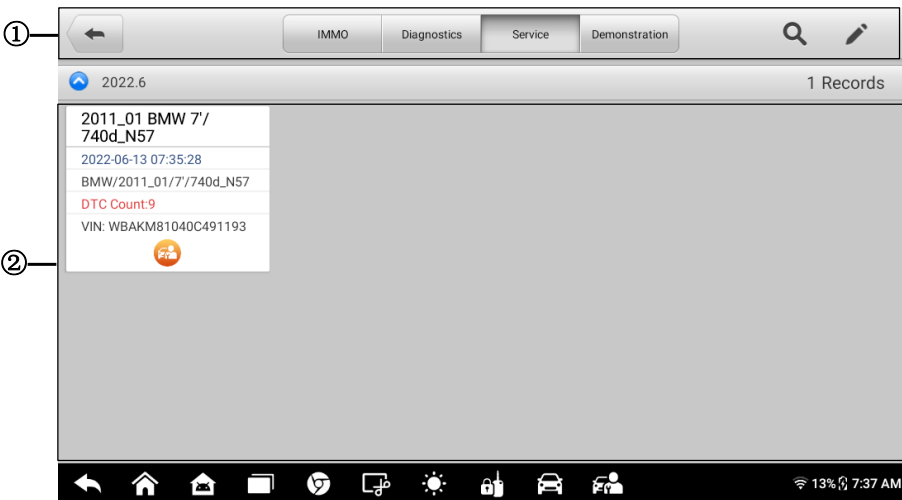

Figure 11-2 Vehicle History (Service) Screen

1. Top Toolbar Buttons — displays navigation and application controls.
2. Main Section — displays all the vehicle history records.

➤ **To activate a test session for the recorded vehicle**

1. Tap **Data Manager** on the MaxilM Job Menu.
2. Tap **Vehicle History** to open the screen. Tap the **IMMO, Diagnostics** or **Service** tab to select IMMO test records, diagnostics test records or service test records.
3. Tap the Diagnostics icon at the bottom of the thumbnail of a vehicle record.
4. The Diagnostics screen of the vehicle displays and a new diagnostics session is activated. See [Diagnostics](#) for detailed instructions. Or,
5. Select a vehicle thumbnail. A historical test record screen display. Review the recorded information of the vehicle, and tap the Diagnostics button on the upper-right corner to continue functions.

11.1.1 Historical Test

The historical test record is a detailed data form of the tested vehicle, which includes general vehicle information, service record, customer information, and the diagnostic trouble codes retrieved from the previous test sessions. Technician notes will also display if present.

➤ **To edit the Historical Test record**

1. Tap **Data Manager** on the MaxilM Job Menu.
2. Tap **Vehicle History**.
3. Select the specific vehicle history record thumbnail from the main section. The **Historical Test** screen will display.
4. Tap **Edit** (a pen icon) to start editing.
5. Tap each item to enter information or attach files or images.

 **NOTE**

The vehicle VIN, license number, and customer account information are correlated by default. Vehicle records will automatically be correlated using this vehicle and customer identification.

6. Tap **Add to customer** to correlate the historical test record sheet to an existing customer account, or add a new associated account to be correlated with the vehicle record. See [Customer](#) for more details.
7. Tap **Done** to save the updated record, or tap **Cancel** to exit without saving.

11.2 Image Files

The Image section contains all captured screenshots.



Figure 11-3 Image Screen

1. **Toolbar Buttons** — used to edit, print or delete the image files. See the following table for detailed information.
2. **Main Section** — displays the stored images.

Table 11-2 Toolbar Buttons in Image

Button	Name	Description
	Back	Returns to the previous screen.
	Edit	Displays the editing toolbar to select, print, delete or email the images.
	Cancel	Closes the editing toolbar or cancels file search.
	Search	Quickly locates the image file by entering the vehicle name, test path, file name or file info.
	Email	Sends the selected images to an email.
	Print	Prints the selected image.
	Delete	Deletes the selected image.

➤ **To edit/delete image(s)**

1. Select **Data Manager** application from the MaxiIM Job Menu.
2. Select **Image** to access the image database.
3. Tap **Edit** (Pen icon) on the top-right corner of the screen. The editing screen displays.
4. Select the image(s) you want to edit.
5. Tap **Delete** (Garbage icon) to delete the selected images or delete all images. Tap **Print** to print the selected image(s) or send the selected image(s) to an email.

11.3 PDF Files

The PDF section stores and displays all PDF files of saved data. After entering the PDF database, select a PDF file to view the stored information.

This section uses the standard Adobe Reader application for file viewing and editing. Please refer to the associated Adobe Reader manual for more detailed instructions.

11.4 Review Data

The Review Data section allows you to playback the recorded data frames of live data streams.

On the Review Data main screen, select a record file to playback. Use the Navigation Toolbar buttons to playback the record data. Tap **Back** to exit data playback.

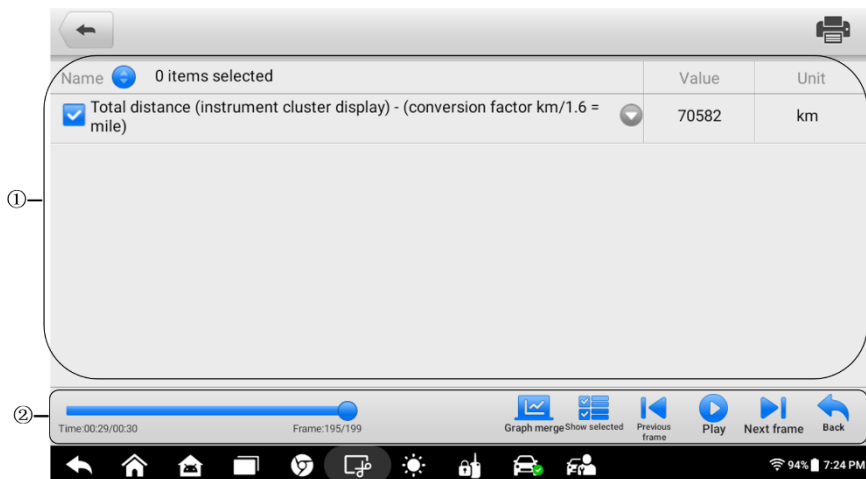

Figure 11-4 Review Data Screen

1. **Main Section** — displays the recorded data frames.
2. **Navigation Toolbar** — allows you to manipulate data playback.

11.5 Uninstall Apps

This section allows you to manage the software installed on the MaxiIM Diagnostics System. Selecting this section opens a managing screen, on which you can check all the available vehicle diagnostic applications.

Select the vehicle software you want to delete by tapping on the car brand, the selected item will display a blue check mark at the upper-right corner. Tap the **Delete** (Garbage icon) button on the top bar to delete the software from the system database.

11.6 Data Logging

The Data Logging section allows you to launch Support platform directly to view all records of all sent or unsent (saved) data loggings on the diagnostic system. See [Data Logging](#) for more details.

11.7 Workshop Information

The Workshop Information form allows you to input, edit, and save the detailed workshop information, such as shop name, address, phone number, and other remarks, which,

when printing vehicle diagnostic reports and other associated test file, will display as the header of the printed documents.

The screenshot shows a mobile application interface for 'Workshop information'. At the top, there is a back arrow icon and the title 'Workshop information'. Below this is a section titled 'Basic information'. The form contains several input fields: 'Set shop logo' and 'Set page footer logo' (each with a camera icon), 'Shop name', 'Tel', 'State', 'Fax', 'City', 'E-mail', 'Zip code', and 'Address'. The bottom of the screen features a dock with icons for navigation and system functions, and a status bar at the very bottom showing a Wi-Fi signal, 13% battery, and the time 7:38 AM.

Figure 11-5 Workshop Information Sheet

- **To edit the Workshop Information sheet**
 1. Tap the **Data Manager** application on the MaxiIM Job Menu.
 2. Select **Workshop Information**.
 3. Tap on each field to input the appropriate information.
 4. Tap **Back** to save the updated workshop information record.

11.8 Customer

The Customer function allows you to create and edit customer accounts. It helps you to save and organize all customer accounts that are correlated with the associated test vehicle history records.

- **To create a customer account**
 1. Tap the **Data Manager** application on the MaxiIM Job Menu.
 2. Select **Customer**.
 3. Tap the **Add a customer** button. An empty information form displays and tap each field to input the appropriate information.

 **NOTE**

The items that must be filled are indicated as required fields.

4. Some customers may have more than one vehicle for service; you can always add new vehicle information to the account. Tap **Add new vehicle information**, and then fill in the vehicle information. Tap the ✕ button to cancel.
5. Tap **Complete** to save the account, or tap **Cancel** to exit without saving.

➤ **To edit a customer account**

1. Tap the **Data Manager** application on the MaxiIM Job Menu.
2. Select **Customer**.
3. Select a customer account by tapping the corresponding name card. A Customer Information record displays.
4. Tap the **Edit** button on the top toolbar to start editing.
5. Tap on the input field to edit or amend information.
6. Tap **Complete** to save the updated information, or tap **Cancel** to exit without saving.

➤ **To delete a customer account**

1. Tap the **Data Manager** application on the MaxiIM Job Menu.
2. Select **Customer**.
3. Select a customer account by tapping the corresponding name card. A Customer Information record displays.
4. Tap the **Edit** button on the top toolbar to start editing.
5. Tap **Delete** on the top of the screen. A reminder message displays.
6. Tap **OK** to confirm the command, and the account is deleted. Tap **Cancel** to cancel the request.

11.9 Report

This section stores and displays all diagnostic reports. The reports stored in this area will be uploaded automatically when you set **ON** to the **Report upload to Cloud** in **Report Settings**. See [Report Settings](#) for further details. Tap one of the reports to view it or save it to the cloud. Select **View local reports** to open it. Tap **Report cloud sharing** to share it.

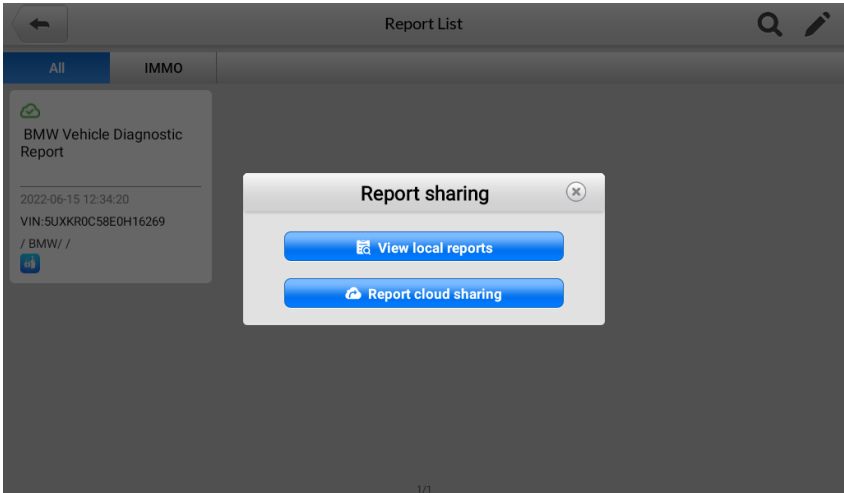

Figure 11-6 Report Sharing Screen

➤ **To share a report**

1. Tap the **Data Manager** application on the MaxiIM Job Menu.
2. Tap **Report** to access the "Report List" screen.
3. Tap a report record to display the "Record Sharing" dialog box.
4. Tap **Report Cloud Sharing**.
5. Scan the QR code or tap **Send Email** or **Send SMS** to share the report.

12 MaxiViewer

The MaxiViewer application allows you to search the functions supported by our tools and the version information. There are two ways of searching, either by searching the product and the vehicle or searching the functions.

➤ To search by the vehicle

1. Tap the **MaxiViewer** application on the MaxiIM Job Menu. The Function Viewer screen displays.
2. Select a product in the Product type drop-down list.
3. Select vehicle brand, model, and year.
4. All the vehicle functions supported by the product are displayed with vehicle's system, type, function, sub-function, and version.

➤ To search by functions

1. Tap **MaxiViewer** on the MaxiIM Job Menu. The Function Viewer screen displays.
2. Select a product in the Product type drop-down list.
3. Tap the **Search** icon. Enter the desired function in the search box. The screen will display all the vehicles that support this function, along with information such as the vehicle's year, system, capacity, type, function, sub-function, and version.

NOTE

Fuzzy search is supported.

13 Support

This application launches the Support platform which synchronizes Autel's on-line service base station with the tablet. In order to synchronize the device to your on-line account, you need to register the product through the Internet when you use it for the first time. The **Support** application is connected to Autel's service channel and on-line communities, which provides the quickest way for problem solutions, allowing you to submit complaints or send help requests to obtain direct services and supports.

13.1 Product Registration

In order to get access to the Support platform and obtain update and other services from Autel, you are required to register the MaxiIM IM508S the first time you use it.

➤ **To register the MaxiIM IM508S**

1. Visit <http://pro.autel.com>.
2. Click **Register** to create your Autel ID.
3. If you already have an Autel ID, log in and skip to Step 11.
4. Enter your personal information. Fields marked with an asterisk (*) are mandatory.
5. Enter your email address, then click **Request**.
6. You will receive an email from Autel with your verification code. Open the email and copy the code into the proper input box.
7. Set a password for your account, and enter the password again to confirm.
8. Read the **Autel User Service Agreement** and **Autel Privacy Policy**, then check the box to accept the terms.
9. After all the information is entered, click **Register**.
10. Once your account is successfully registered, you will be redirected to the Product Registration screen. If not, click the button on the screen.
11. Your product serial number and password are required to complete your registration. To find your serial number and password on the tablet: go to **Settings > About**.
12. Enter your tablet's serial number and password.
13. Enter the CAPTCHA code as shown.
14. Click **Submit** to complete your product registration.

13.2 Support Screen Layout

The main section of the Support screen is divided into two sections. The narrow column on the left is the main menu; selecting one subject from the main menu displays the corresponding function interface on the right.



Figure 13-1 Support Screen

13.2.1 My Account

The My Account screen displays the comprehensive information of the user and the device.

- **User information** — displays detailed information of your registered on-line Autel account, such as your Autel ID, real name, country/district, town/city, company/institute, address, and post code.
- **Device information** — displays the registered product information, including the product serial number, registration time, expired time, and warranty period.

13.2.2 Data Logging

The Data Logging screen keeps records of all **Feedback** (submitted), **No feedback** (saved) or **History** (up to the latest 20 test records) data loggings on the diagnostics system. The support personnel receive and process the submitted reports through the Support platform, and send back problem solutions within 48 hours to the corresponding Data Logging session, on which you can have a direct conversation with the support personnel.

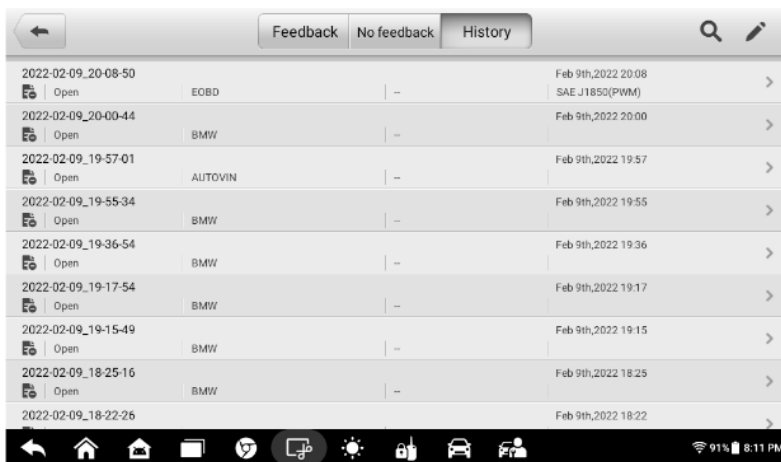

Figure 13-2 Data Logging Screen

➤ **To make a reply in a Data Logging session**

1. Tap **Feedback** to view a list of submitted data loggings.
2. Select a specific item to view the latest update of the processing progress.
3. Tap the text field at the bottom of the screen, and enter the texts, or tap the **Audio** button to record a voice message, or **Camera** button to take a picture.
4. Tap **Send** to deliver your message to the technical center.

13.2.3 Training

The Training section provides quick links to Autel’s online video accounts. Select a video channel by the language to see all the available online tutorial videos from Autel for various technical supports, such as product usage techniques and vehicle diagnostics practice, etc.

13.2.4 FAQ

The FAQ tab provides you the comprehensive and abundant references for all kinds of questions frequently asked and answered about the use of Autel’s online member account, shopping, and payment procedures.

- **Account** — displays questions and answers about the use of Autel’s online user account.
- **Shopping & Payment** — displays questions and answers about online product purchase and payment methods or procedures.

14 Quick Link

The Quick Link application provides you with convenient access to Autel's official website and many other well-known sites in automotive service, which offer you abundant information and resources, such as technical help, knowledge base, forums, training, and expertise consultations.

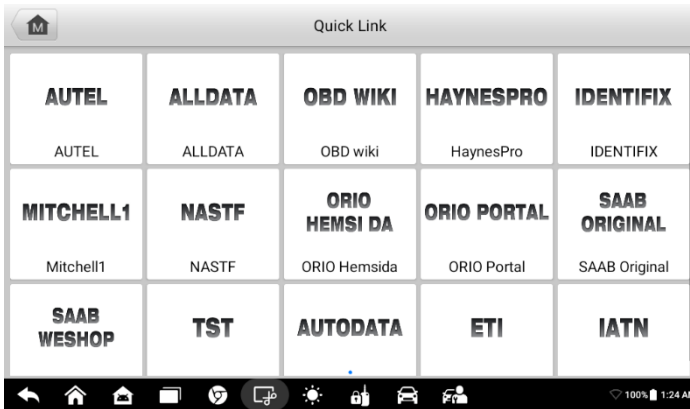

Figure 14-1 Quick Link Screen

➤ **To access a quick link**

1. Tap **Quick Link** on the MaxiIM Job Menu. The **Quick Link** screen displays.
2. Select a website thumbnail from the main section. The browser is launched and the selected website is opened.
3. Now you can start exploring the website.

15 Maintenance and Service

15.1 Maintenance Instructions

The following shows how to maintain your devices, together with precautions to take.

- Use a soft cloth and alcohol or a mild window cleaner to clean the touch screen of the tablet.
- Do not use any abrasive cleansers, detergent, or automotive chemicals to the tablet.
- Maintain the devices in dry conditions and keep them within normal operating temperatures.
- Dry your hands before using the tablet. The touch screen of the tablet may not work if the touch screen is moist, or if you tap the touch screen with wet hands.
- Do not store the devices in humid, dusty or dirty areas.
- Check the housing, wiring, and connectors for dirt and damage before and after each use.
- At the end of each work day, wipe the device housing, wiring, and connectors clean with a damp cloth.
- Do not attempt to disassemble your tablet or the VCI unit.
- Do not drop or cause severe impact to the devices.
- Use only authorized battery chargers and accessories. Any malfunction or damage caused by the use of unauthorized battery charger and accessories will void the limited product warranty.
- Ensure that the battery charger does not come in contact with conductive objects.
- Do not use the tablet beside microwave ovens, cordless phones and some medical or scientific instruments to prevent signal interference.

15.2 Troubleshooting Checklist

A. When the Tablet does not work properly:

- Make sure the tablet has been registered online.
- Make sure the system software and diagnostic application software are properly updated.
- Make sure the tablet is connected to the Internet.
- Check all cables, connections, and indicators to see if the signal is being received.

B. When battery life is shorter than usual:

- This may happen when you are in an area with low signal strength. Turn off your device if it is not in use.

C. When you cannot turn on the tablet:

- Make sure the tablet is connected to a power source or the battery is charged.

D. When you are unable to charge the tablet:

- Your charger maybe out of order. Contact your nearest dealer.
- You may be attempting to use the device in an overly hot/cold temperature. Charge the device in a cooler or warmer area.
- Your device may have not been connected to the charger properly. Check the connector.

 **NOTE**

If the problems persist, please contact Autel's technical support personnel or your local selling agent.

15.3 About Battery Usage

Your tablet is powered by a built-in Lithium-ion Polymer battery. This means that, unlike other forms of battery technology, you can recharge your battery while some charge remains without reducing your tablet's autonomy due to the "battery memory effect" inherent in those technologies.

 **DANGER**

The built-in Lithium-ion Polymer battery is factory replaceable only; incorrect replacement or tampering with the battery pack may cause an explosion.

Do not use a damaged battery charger.

- Do not disassemble or open crush, bend or deform, puncture or shred.
- Do not modify or remanufacture, attempt to insert foreign objects into the battery, expose to fire, explosion or another hazard.
- Use only the included charger and USB cables. Failure to use Autel-authorized charger and/or USB cables may result in device malfunction or failure.
- Use of an unqualified battery or charger may present a risk of fire, explosion, leakage, or another hazard.
- Avoid dropping the tablet. If the tablet is dropped, especially on a hard surface, and the user suspects damage, take it to a service center for inspection.
- The closer you are to your network's wireless router, the longer your tablet usage time because less battery power is consumed for the connection.

- The battery recharging time varies depending on the remaining battery capacity.
- Battery life inevitably shortens over time.
- Since overcharging may shorten battery life, remove the tablet from its charger once it is fully charged. Unplug the charger, once charging is complete.
- Leaving the tablet in hot or cold places, especially inside a car in summer or winter, may reduce the capacity and life of the battery. Always keep the battery within normal temperatures.

16 Compliance Information

FCC Compliance

FCC ID: WQ8-MX808S2151

This device complies with Part 15 of the FCC rules and Industry Canada's license-exempt RSSs. Operation is subject to the following two conditions:

1. This device may not cause harmful interference.
2. This device must accept any interference received, including interference that may cause undesired operation.

Cet appareil est conforme aux CNR exempts de licence d'Industrie Canada. Son fonctionnement est soumis aux deux conditions suivantes:

1. Ce dispositif ne peut causer des interférences; et
2. Ce dispositif doit accepter toute interférence, y compris les interférences qui peuvent causer un mauvais fonctionnement de l'appareil.

WARNING

Changes or modifications not expressly approved by the party responsible for compliance could void the user's authority to operate the equipment.

NOTE

This equipment has been tested and found to comply with the limits for a Class B digital device, pursuant to Part 15 of the FCC Rules. These limits are designed to provide reasonable protection against harmful interference in a residential installation.

This equipment generates uses and can radiate radio frequency energy and, if not installed and used in accordance with the instructions, may cause harmful interference to radio communications. However, there is no guarantee that interference will not occur in a particular installation. If this equipment does cause harmful interference to radio or television reception, which can be determined by turning the equipment off and on, the user is encouraged to try to correct the interference by one or more of the following measures:

- Reorient or relocate the receiving antenna.
- Increase the separation between the equipment and receiver.
- Connect the equipment into an outlet on a circuit different from that to which the receiver is connected.
- Consult the dealer or an experienced radio/TV technician for help.

Changes or modifications not expressly approved by the party responsible for compliance could void the user's authority to operate the equipment.

SAR

The radiated output power of this device is below the FCC radio frequency exposure limits. Nevertheless, the device should be used in such a manner that the potential for human contact is minimized during normal operation.

The exposure standard for wireless devices employs a unit of measurement known as the Specific Absorption Rate, or SAR. The SAR limit set by the FCC is 1.6 W/Kg. Tests for SAR are conducted using standard operating positions accepted by the FCC with the device transmitting at its highest certified power level in all tested frequency bands.

Although the SAR is determined at the highest certified power level, the actual SAR level of the device while operating can be well below the maximum value. This is because the device is designed to operate at multiple power levels so as to use only the power required to reach the network. To avoid the possibility of exceeding the FCC radio frequency exposure limits, human proximity to antenna should be minimized.

RF WARNING STATEMENT

The device has been evaluated to meet general RF exposure requirement. The device can be used in portable exposure condition without restriction.

The term "IC" before the radio certification number only signifies that IC technical specifications were met.

RoHS COMPLIANCE

This device is declared to be in compliance with the European RoHS Directive 2011/65/EU.

CE COMPLIANCE

This product is declared to conform to the essential requirements of the following Directives and carries the CE mark accordingly:

Radio Equipment Directive 2014/53/EU

17 Warranty

Limited One Year Warranty

Autel Intelligent Technology Corp., Ltd. (the Company) warrants to the original retail purchaser of this MaxilM Diagnostic Device, that should this product or any part thereof during normal consumer usage and conditions, be proven defective in material or workmanship that results in product failure within one (1) year period from the date of purchase, such defect(s) will be repaired, or replaced (with new or rebuilt parts) with Proof of Purchase, at the Company's option, without charge for parts or labor directly related to the defect(s).

The Company shall not be liable for any incidental or consequential damages arising from the use, misuse, or mounting of the device. Some states do not allow limitation on how long an implied warranty lasts, so the above limitations may not apply to you.

This warranty does not apply to:

- a) Products subjected to abnormal use or conditions, accident, mishandling, neglect, unauthorized alteration, misuse, improper installation or repair or improper storage;
- b) Products whose mechanical serial number or electronic serial number has been removed, altered or defaced;
- c) Damage from exposure to excessive temperatures or extreme environmental conditions;
- d) Damage resulting from connection to, or use of any accessory or other product not approved or authorized by the Company;
- e) Defects in appearance, cosmetic, decorative or structural items such as framing and non-operative parts.
- f) Products damaged from external causes such as fire, dirt, sand, battery leakage, blown fuse, theft or improper usage of any electrical source.

! IMPORTANT

All contents of the product may be deleted during the process of repair. You should create a back-up copy of any contents of your product before any repair services.
