

Trademarks

Autel® and MaxilM® are trademarks of Autel Intelligent Technology Corp., Ltd., registered in China, the United States and other countries. All other marks are trademarks or registered trademarks of their respective holders.

Copyright Information

No part of this manual may be reproduced, stored in a retrieval system or transmitted, in any form or by any means, electronic, mechanical, photocopying, recording, or otherwise without the prior written permission of Autel.

Disclaimer of Warranties and Limitation of Liabilities

All information, specifications and illustrations in this manual are based on the latest information available at the time of printing.

Autel reserves the right to make changes at any time without notice. While information of this manual has been carefully checked for accuracy, no guarantee is given for the completeness and correctness of the contents, including but not limited to the product specifications, functions, and illustrations.

Autel will not be liable for any direct, special, incidental, indirect damages or any economic consequential damages (including the loss of profits).

IMPORTANT

Before operating or maintaining this unit, please read this manual carefully, paying extra attention to the safety warnings and precautions.

For Services and Support

 www.autel.com

 support@autel.com

For technical assistance in all other markets, please contact your local selling agent.

Safety Information

For your own safety and the safety of others, and to prevent damage to the device and vehicles upon which it is used, it is important that the safety instructions presented throughout this manual be read and understood by all persons operating or coming into contact with the device.

There are various procedures, techniques, tools, and parts for servicing vehicles, as well as in the skill of the person doing the work. Because of the vast number of test applications and variations in the products that can be tested with this equipment, we cannot possibly anticipate or provide advice or safety messages to cover every circumstance. It is the automotive technician's responsibility to be knowledgeable of the system being tested. It is crucial to use proper service methods and test procedures. It is essential to perform tests in an appropriate and acceptable manner that does not endanger your safety, the safety of others in the work area, the device being used, or the vehicle being tested.

Before using the device, always refer to and follow the safety messages and applicable test procedures provided by the manufacturer of the vehicle or equipment being tested. Use the device only as described in this manual. Read, understand, and follow all safety messages and instructions in this manual.

Safety Messages

Safety messages are provided to help prevent personal injury and equipment damage. All safety messages are introduced by a signal word indicating the hazard level.

DANGER

Indicates an imminently hazardous situation which, if not avoided, will result in death or serious injury to the operator or to bystanders.

WARNING

Indicates a potentially hazardous situation which, if not avoided, could result in death or serious injury to the operator or to bystanders.

Safety Instructions

The safety messages herein cover situations Autel is aware of. Autel cannot know, evaluate or advise you as to all of the possible hazards. You must be certain that any condition or service procedure encountered does not jeopardize your personal safety.

DANGER

When an engine is operating, keep the service area WELL VENTILATED or attach a building exhaust removal system to the engine exhaust system. Engines produce carbon monoxide, an odorless, poisonous gas that causes slower reaction time and can lead to serious personal injury or loss of life.

SAFETY WARNINGS

- Always perform automotive testing in a safe environment.
- Wear safety eye protection that meets ANSI standards.
- Keep clothing, hair, hands, tools, test equipment, etc. away from all moving or hot engine parts.
- Operate the vehicle in a well ventilated work area, for exhaust gases are poisonous.
- Put the transmission in PARK (for automatic transmission) or NEUTRAL (for manual transmission) and make sure the parking brake is engaged.
- Put blocks in front of the drive wheels and never leave the vehicle unattended while testing.
- Be extra cautious when working around the ignition coil, distributor cap, ignition wires and spark plugs. These components create hazardous voltages when the engine is running.
- Keep a fire extinguisher suitable for gasoline, chemical, and electrical fires nearby.
- Do not connect or disconnect any test equipment while the ignition is on or the engine is running.
- Keep the test equipment dry, clean, free from oil, water or grease. Use a mild detergent on a clean cloth to clean the outside of the equipment as necessary.
- Do not drive the vehicle and operate the test equipment at the same time. Any distraction may cause an accident.

- Refer to the service manual for the vehicle being serviced and adhere to all diagnostic procedures and precautions. Failure to do so may result in personal injury or damage to the test equipment.
- To avoid damaging the test equipment or generating false data, make sure the vehicle battery is fully charged and the connection to the vehicle DLC is clean and secure.
- Do not place the test equipment on the distributor of the vehicle. Strong electro-magnetic interference can damage the equipment.

CONTENTS

1	USING THIS MANUAL	1
	CONVENTIONS	1
2	GENERAL INTRODUCTION	3
	MAXIIM IM608 DISPLAY TABLET	3
	MAXIFLASH – WIRELESS DIAGNOSTIC INTERFACE	7
	XP400	10
	ACCESSORIES KIT	20
3	GETTING STARTED	23
	POWERING UP	23
	POWERING DOWN.....	27
4	IMMO	28
	ESTABLISH VEHICLE COMMUNICATION	28
	GETTING STARTED	33
	VEHICLE IDENTIFICATION	34
	NAVIGATION	37
	IMMO	41
5	PROGRAMMING	51
	PROGRAMMING.....	51
6	DIAGNOSTICS	60
	DIAGNOSIS.....	60
	GENERIC OBD II OPERATIONS.....	74
	EXITING DIAGNOSTICS.....	78
7	SERVICE	80
	OIL RESET SERVICE	80
	ELECTRONIC PARKING BRAKE (EPB) SERVICE	83
	STEERING ANGLE SENSOR (SAS) SERVICE	91
	DPF SERVICE	95
8	UPDATE	99
9	SETTINGS.....	102

UNIT.....	102
LANGUAGE.....	103
PRINTING SETTING.....	104
NOTIFICATION CENTER.....	105
AUTO UPDATE.....	106
ABOUT.....	108
SYSTEM SETTINGS.....	108
10 REMOTE DESK.....	110
11 DATA MANAGER.....	112
OPERATIONS.....	112
12 SHOP MANAGER.....	117
VEHICLE HISTORY.....	118
WORKSHOP INFORMATION.....	121
CUSTOMER MANAGER.....	121
13 VCI MANAGER.....	125
BT PAIRING.....	126
UPDATE.....	126
14 MAINTENANCE AND SERVICE.....	128
MAINTENANCE INSTRUCTIONS.....	128
TROUBLESHOOTING CHECKLIST.....	129
ABOUT BATTERY USAGE.....	129
15 COMPLIANCE INFORMATION.....	131
16 WARRANTY.....	134
LIMITED ONE YEAR WARRANTY.....	134

1 Using this Manual

This manual contains device usage instructions.

Some illustrations shown in this manual may contain modules and optional equipment that are not included in your system.

Conventions

The following conventions are used.

Bold Text

Bold text is used to highlight selectable items such as buttons and menu options.

Example:

- Tap **OK**.

Notes and Important Messages

Notes

A **NOTE** provides helpful information such as additional explanations, tips, and comments.

Example:

NOTE

New batteries reach full capacity after approximately 3 to 5 charging and discharging cycles.

Important

IMPORTANT indicates a situation which, if not avoided, may result in damage to the tablet or vehicle.

Example:

! IMPORTANT

Keep the cable away from heat, oil, sharp edges and moving parts. Replace damaged cables immediately.

Hyperlink

Hyperlinks, or links, that take you to other related articles, procedures, and illustrations are available in electronic documents. Blue italic text indicates a selectable hyperlink and blue underlined text indicates a website link or an email address link.

Illustrations

Illustrations used in this manual are samples, the actual testing screen may vary for each vehicle being tested. Observe the menu titles and on-screen instructions to make correct option selection.

2 General Introduction

Autel presents the MaxiIM IM608 as the most advanced and smart key programming tool that combines the most powerful IMMO and programming functions with OE-level diagnostics and advanced service functions in one Android based 10.1-inch touchscreen tablet.

With the included key programmer XP400 and MaxiFlash ECU Reprogrammer, MaxiIM IM608 is destined to be the unprecedented key programming tool that you ever wanted!

This manual describes the construction and operation of the device and how it works to deliver key programming and diagnostic solutions.

MaxiIM IM608 Display Tablet

Functional Description

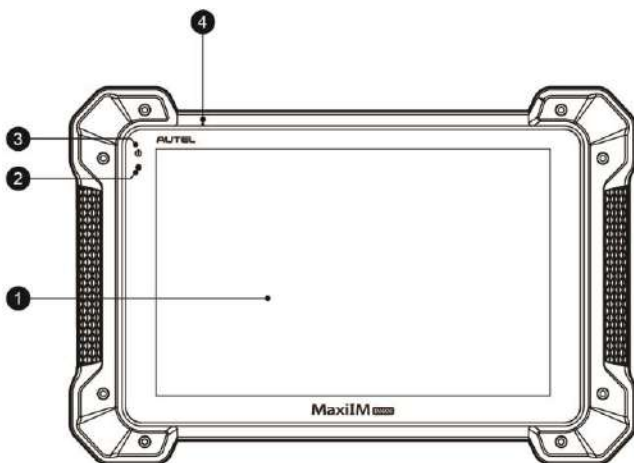

Figure 2-1 Display Tablet Front View

1. 10.1-inch LCD Capacitive Touchscreen

2. Ambient Light Sensor – detects ambient brightness.
3. Power LED – indicates battery level & charging or system status.
4. Microphone

The power LED displays green, yellow or red depending on power level and operating state.

A. Green

- Illuminates green when the Display Tablet is charging and the battery level is above 90%.
- Illuminates green when the Display Tablet is powered on and the battery level is above 15%.

B. Yellow

- Illuminates yellow when the Display Tablet is charging and the battery level is below 90%.

C. Red

- Illuminates red when the Display Tablet is powered on and the battery level is below 15%.

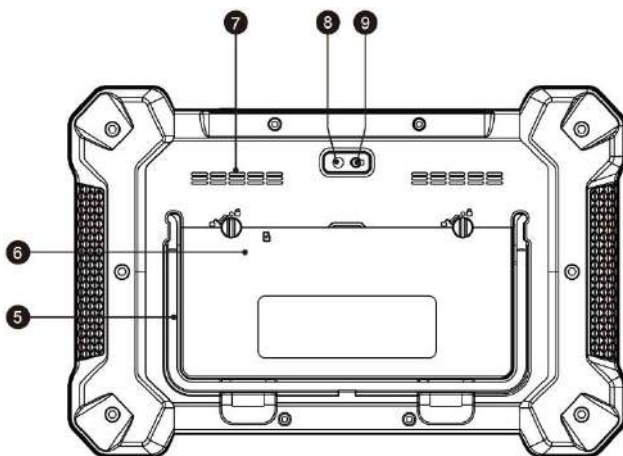

Figure 2-2 Display Tablet Back View

5. Collapsible Stand – extends from the back to allow hands-free viewing of the Display Tablet.

6. Built-in Battery
7. Loudspeaker
8. Camera Lens
9. Camera Flash

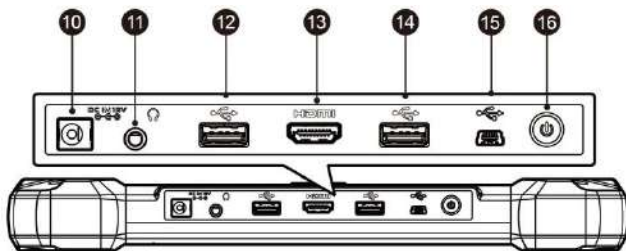

Figure 2-3 Display Tablet Top View

10. DC Power Supply Input Port
11. Headphone Jack
12. USB Port
13. HDMI (high-definition multimedia interface) Port
14. USB Port
15. Mini USB Port
16. Lock/Power Button – turns the device on & off with long press, or locks the screen with short press.

Power Sources

The Display Tablet can receive power from any of the following sources:

- Internal Battery Pack
- External Power Supply

Internal Battery Pack

The Display Tablet can be powered with the internal rechargeable battery, which if fully charged can provide sufficient power for about 4.5 hours of continuous operation.

External Power Supply

The Display Tablet can be powered from a wall socket using the AC/DC power adapter. The AC/DC power supply also charges the internal battery pack.

Technical Specifications

Table 2-1 Specifications

Item	Description
Operating System	Android™ 4.4.2, KitKat
Processor	Samsung Exynos hexa-core Processor (1.3GHz Quad-core ARM Cortex-A7 + 1.7GHz Dual-core ARM Cortex-A15)
Memory	2GB RAM & 64GB On-board Memory
Display	10.1-inch LED capacitive touch screen with 1920x1200 resolution
Connectivity	Wi-Fi (802.11 a/b/g/n/ac) USB: 2.0 BT v.2.1 + EDR SD Card (Support up to 32GB) HDMI
Camera (rear)	8.0 Megapixel, AF with Flashlight
Sensors	Gravity Accelerometer, Ambient Light Sensor (ALS)
Audio	Microphone
Input/Output	Dual Speakers 3-Band 3.5 mm stereo/standard headset jack
Power and Battery	15000 mAh 3.8 V lithium-polymer battery Charging via 12 V AC/DC power supply with the temperature between 0°C and 45°C
Input Voltage	12 V (9-24 V)

Item	Description
Power Consumption	6.5 W
Operating Temp.	0 to 50°C (32 to 122°F)
Storage Temp.	-20 to 60°C (-4 to 140°F)
Dimensions (WxHxD)	300 mm (11.81") x 220 mm (8.66") x 50 mm (1.97")
Weight	NW: 1.42 kg (3.13 lb.) GW: 8.655 kg (19.08 lb.)
Protocols	ISO 9142-2, ISO 14230-2, ISO 15765-4, K/L-Line, Flashing Code, SAE-J1850 VPW, SAE-J1850 PWM, CAN ISO 11898, Highspeed, Middlespeed, Lowspeed and Singlewire CAN, GM UART, UART Echo Byte Protocol, Honda Diag-H Protocol, TP 2.0, TP 1.6, SAE J1939, SAE J1708, Fault-Tolerant CAN

MaxiFlash – Wireless Diagnostic Interface

This multi-protocol Pass-Thru vehicle interface is a fully compliant SAE J2534-1 & SAE J2534-2 (March 2006) device, specially designed to provide users with convenient PC communication and ECU reprogramming capabilities on any modern vehicle diagnostic bus, and offer the most significant features desired by OEM customers: reliability, fast performance and flexibility.

Functional Description

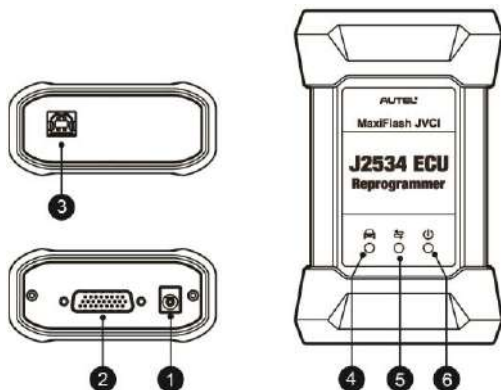

Figure 2-4 MaxiFlash Views

1. Power Port – connects the device and the power source with the adapter.
2. Vehicle Connector – connects the device to the vehicle's DLC via a standard high density DB-26 MVCI – OBDII cable.
3. USB Port
4. Vehicle LED
5. Connection LED
6. Power LED

Table 2-2 LED Status

LED	Color	Description
Vehicle	Green	Flashes green when communicating with the vehicle's system. <i>Note: Do not disconnect while this status LED is on! If you interrupt the flash reprogramming procedure while the vehicle's ECU is blank or only partially programmed, the module may be unrecoverable.</i>

Connection	Green	Illuminates solid green when properly connected with the display tablet via the USB cable.
	Blue	Illuminates solid blue when connected with the display tablet via wireless (BT) connection.
Power	Green	Illuminates solid green when powered on.
	Red	Flashes red when system failure occurs.
	Amber	The power LED illuminates amber automatically every time when the device is power up, which is a normal self-test procedure, and it will turn green automatically later when the device starts working normally.

Technical Specifications

Table 2-3 Specifications

Name	Value
Communications	Wireless BT V2.1 + EDR, USB 2.0
Wireless Frequency	Wireless BT V2.1+EDR, 2.4GHz
Input Voltage Range	12VDC to 24VDC
Supply Current	170mA @ 12VDC 100mA @ 24VDC
Operating Temperature	0°C to +60°C (ambient)
Storage Temperature	-65°C to +100°C (ambient)
Dimensions (L*W*H)	149 mm * 86mm * 35 mm
Weight	0.29kg (0.64lb)

XP400

The XP400 is specially designed to read transponder data (including Mercedes Benz infrared smart key), clone and generate exclusive keys, read/write on-board EEPROM data, and read/write Freescale 9S12 MCUs. By working with diagnostic tool and PC that are both loaded with programmer software, the XP400 can read/write transponder data quickly and accurately.

Functional Description

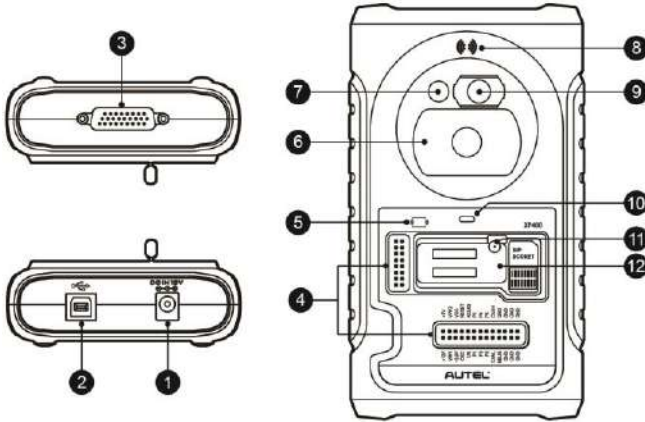

Figure 2-5 XP400 Views

1. DC Port – provides 12V DC power supply.
2. USB Port – provides data communication and 5V DC power supply.
3. DB 26-Pin Port – connects with the Mercedes Benz infrared cable, vehicle key cable, ECU cable, MCU cable, MC9S12 cable.
4. Cross Signal Pins – holds the MCU board, MCU spare cable or DIY signal interface.
5. IC Card Induction Area
6. Vehicle Key Slot – holds the vehicle key.
7. Transponder Slot – holds the transponder.

8. Remote Control Transponder Induction Area
9. Mercedes Infrared Key Slot – holds the Mercedes infrared key.
10. Status LED – indicates the current operating status.
11. Locker – locks the EEPROM component transponder slot to ensure proper functioning.
12. EEPROM Component Transponder Slot – holds the EEPROM plug-in transponder or EEPROM socket.

DC Port

DC Port is used to provide 12 V power supply for the XP400.

USB Port

The Type B USB port provides data communication and power supply for handheld device, PC and XP400.

DB 26-Pin Port

Five components can be connected to this port: Mercedes Infrared Cable, APA102 – Remote Match Cable (optional), APA104 – ECU Cable, APA105 – MCU Cable and APA106 – MC9S12 Cable.

1. APA102 – Remote Match Cable (optional)

Table 2-4 Definitions of Remote Match Cable

No.	Color	Definition	Pin correspond to DB26	Note
1	Red	VCC5V	16	
2	Black	GND	3/10/25	
3	Blue and White	REMOTE_MISO	14	
4	Gray and White	REMOTE_MOSI	5	

5	Brown and White	REMOTE_CLK	23	
6	Green and White	REMOTE_RX_CS	15	

2. APA104 – ECU Cable

Table 2-5 Definitions of ECU Cable

No.	Color	Definition	Pin correspond to DB26	Note
1	Red	VCC12V	7	
2	Black	GND	25	
3	Green	IGN	/	
4	Orange	CANL	8	
5	Blue	CANH	17	
6	Brown	BOOTM	/	
7	Yellow	K	18	
8	White	LIN	26	

3. APA105 – MCU Cable

Table 2-6 Definitions of MCU Cable

No.	Color	Definition	Pin correspond to DB26	Note
1	Red and White	VPP1	20	
2	Red and Black	VPP2	12	
3	Red and Yellow	+12V	7	
4	Red and Blue	VPPR	/	

5	Black	GND	25	
6	White	S1	14	
7	Brown	S2	5	
8	Gray	S3	23	
9	Blue	S4	11	
10	Red	S5	21	
11	Orange	S6	13	
12	Purple	S7	4	
13	Yellow	S8	19	
14	Green	S9	2	
15	Black	GND	10	Shielded Twisted
16	White	OSC	1	Shielded Twisted

4. APA106 – MC9S12 Cable

Table 2-7 Definitions of MC9S12 Cable

No.	Color	Definition	Pin correspond to DB26	Note
1	Red	+5V	16	
2	Black	GND	25	
3	Green	XCLKS	2	
4	Blue	T/R	11	
5	Yellow	RESET	19	
6	Black	GND	10	Shielded Twisted

7	White	OSC	1	Shielded Twisted
---	-------	-----	---	---------------------

Cross-shaped Signal Pin

The Cross-shaped signal pin is used to place MCU board, MCU spare cable or DIY signal cable to read or write MCU and ECU chips.

IC Card Induction Area

It is used to read and write IC card information.

Vehicle Key Slot

It is used to hold the vehicle key to read or write vehicle key information.

Transponder Slot

It is used to hold the transponder to read or write transponder information.

Remote Control Transponder Induction Area

It is used to read and write remote control transponder information.

Mercedes Infrared Key Slot

It is used to hold Mercedes infrared key to read or write Mercedes vehicle key information.

Status LED

The Status Indicator shows the current operating status of the XP400. See the table below for detailed description.

Table 2-8 Description of the Status LED

Indicator	Status	Description
On	Light Green	Powered on and default
	Flash Green	Communication
	Light Red	Error

Locker

It is used to place EEPROM chip or socket to read or write EEPROM information.

EEPROM Component Transponder Slot

It is used to hold the EEPROM plug-in transponder or EEPROM socket.

EEPROM Read/Write Transponder Coverage

Chip Type	Name	Chip Type	Name
ATMEL	AT24C01	ATMEL	AT24C1024
ATMEL	AT24C02	ATMEL	AT24C128_1.8
ATMEL	AT24C04	ATMEL	AT24C256_1.8
ATMEL	AT24C08	ATMEL	AT24C512_1.8
ATMEL	AT24C16	ATMEL	AT24C01A
ATMEL	AT24C32	ST	ST24x01/ST25x01
ATMEL	AT24C64	ST	ST24x02/ST25x02
ATMEL	AT24C128	ST	ST24x04/ST25x04
ATMEL	AT24C256	ST	ST24x08/ST25x08
ATMEL	AT24C512	ST	ST24x16/ST25x16
ST	M24C01	ATMEL	AT25640
ST	M24C02	ATMEL	AT25128
ST	M24C04	ATMEL	AT25256
ST	M24C08	ATMEL	AT25512
ST	M24C16	ATMEL	AT25010_1.8
ST	M24C32	ATMEL	AT25020_1.8
ST	M24C64	ATMEL	AT25040_1.8

Chip Type	Name	Chip Type	Name
FAIRCHILD	NM24C16U	ATMEL	AT25080_1.8
FAIRCHILD	NM24C16UT	ATMEL	AT25160_1.8
FAIRCHILD	NM24C17U	ATMEL	AT25320_1.8
FAIRCHILD	NM24C17UT	ATMEL	AT25640_1.8
MICROCHIP	85C72	ATMEL	AT25128_1.8
MICROCHIP	85C82	ATMEL	AT25256_1.8
MICROCHIP	85C92	ST	M95010
NXP	PCF8582C	ST	M95020
NXP	PCF8594C	ST	M95040
NXP	PCF8598C	ST	M95080
ATMEL	AT25010	ST	M95160
ATMEL	AT25020	ST	M95320
ATMEL	AT25040	ST	M95640
ATMEL	AT25080	ST	M95128
ATMEL	AT25160	ST	M95256
ATMEL	AT25320	ST	M95512
MICROCHIP	25xx040	NATIONAL	NM93C13
MICROCHIP	25xx080	NATIONAL	NM93C14
MICROCHIP	25xx160	NATIONAL	NM93C14TM8
MICROCHIP	25xx320	MICROCHIP	93C46X
MICROCHIP	25xx640	MICROCHIP	93C46A
MICROCHIP	25xx040_TSS OP	MICROCHIP	93C46

Chip Type	Name	Chip Type	Name
MICROCHIP	25xx320_TSS OP	MICROCHIP	93C46AX
MICROCHIP	25xx640_TSS OP	MICROCHIP	93C46BX_93C46 CX
CATALYST	CAT25C01	MICROCHIP	93C56A
CATALYST	CAT25C02	MICROCHIP	93C56
CATALYST	CAT25C04	MICROCHIP	93C66A
CATALYST	CAT25C08	MICROCHIP	93C66
CATALYST	CAT25C16	MICROCHIP	93C76A
CATALYST	CAT25C32	MICROCHIP	93C76
CATALYST	CAT25C64	MICROCHIP	93C86A
CATALYST	CAT25C128	MICROCHIP	93C86
CATALYST	CAT25C256	ATMEL	AT93C46A
ST	M35080	ATMEL	AT93C46
XICOR	X5043	ATMEL	AT93C46R
XICOR	X5045	ATMEL	AT93C56
XICOR	X25043	ATMEL	AT93C57
XICOR	X25045	ATMEL	AT93C66
MICROCHIP	93C06	ATMEL	AT93C76
ATMEL	AT93C86	SONY	CXK1011
NATIONAL	NM93CS06	SONY	CXK1012
NATIONAL	NM93CS46	SONY	CXK1013
NATIONAL	NM93CS56	Seiko	S_24H30
NATIONAL	NM93CS66	Seiko	S_24H30_SOP8

Chip Type	Name	Chip Type	Name
FAIRCHILD	FM93CS46T	Seiko	S_24H45
ST	M93C46	Seiko	S_24H45_SOP8
ST	M93C56	Seiko	S_24S30
ST	M93C66	Seiko	S_24S45
ST	M93C76	TOSHIBA	TC89101
ST	M93C86	TOSHIBA	TC89102
ST	M93S46	TOSHIBA	TC89121
ST	M93S56	TOSHIBA	TC89122
ST	M93S66	Xicor	X24C44
ATMEL	AT59C11	TMC	TMC93LC56
ATMEL	AT59C22	TMC	TMC93LC57
ATMEL	AT59C13	TMC	TMC93LC66
OKI	MSM16911	TMC	TMC93LC86
TMC	TMC93LC46		

MCU/ECU Read/Write Transponder Coverage

Chip Type	Name
FREESCALE	MC9S12DG128
FREESCALE	MC9S12DJ64
FREESCALE	MC9S12DG256
FREESCALE	MC9S12DT128
FREESCALE	MC9S12DT256
FREESCALE	MC9S12XDP512
FREESCALE	MC9S12XET512

FREESCALE	MC68HC08AZ60
FREESCALE	MC68HC(9)08AB16A
FREESCALE	MC68HC908GR16A
FREESCALE	MC68HC(7)05X32
FREESCALE	MC68HC705E6
FREESCALE	MC68HC11E9
INFINEON	SAK-TC1766
INFINEON	SAK-TC1793
INFINEON	SAK-TC1796
INFINEON	SAK-TC1797

Technical Specifications

Table 2-9 Specifications

Item	Description
Operating Temperature	-10°C ~ 60°C (14°F ~ 140°F)
Storage Temperature	-20°C ~ 60°C (-4°F ~ 140°F)
Port	Mini USB, VGA_DB15
Input Voltage	5 VDC
Operating Current	< 250 mA
Maximum Consumption	1 W
Device Dimensions (L*W*H)	130 mm * 68 mm * 28 mm
Package Dimensions (L*W*H)	201 mm * 167 mm * 75 mm
Net Weight	466 g

Accessories Kit

Main Cable

The Main Cable connects the MaxiFlash JVC1 to the vehicle's data link connector (DLC). Note: Don't use the Main Cable to connect XP400 to the vehicle's DLC.

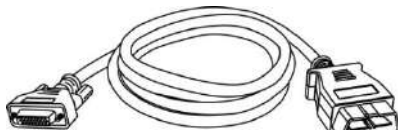

Figure 2-6 *Main Cable*

Other Included Accessories



USB Cable



Mini USB Cable

Connects the Display Tablet to the PC.



AC/DC Adapter (12V)

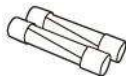

Light Fuse

6*30mm (2pcs)



Cigarette Lighter



AAC001

MED17 Cable



APC001 (USB Cable)

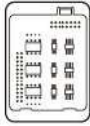

APB101+APD101

EEPROM Adaptor + EEPROM Adaptor Shell



APB102

MB IR Cable

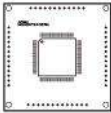

APB104

MCU_FQFP64



APB105

MCU_FQFP80

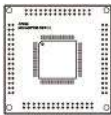

APB106

MCU_FQFP112

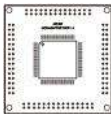

APB107

MCU_FQFP114

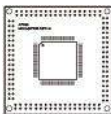

APB108

MCU_FQFP176



APA002

EEPROM Socket



APA101

Signal Cable



APA103
EEPROM Clamp



APA104
ECU Cable



APA105
MCU Cable



APA106
MC9S12 Cable



APA107
Connect Cable



Quick Guide

Device connection and software update instructions.

3 Getting Started

Ensure the tablet is sufficiently charged or is connected to the external power supply (see [Power Sources](#) on page 5).

NOTE

The images and illustrations depicted in this manual may differ from the actual ones.

Powering Up

Long press the Lock/Power button on the top right of the tablet to power on the unit. The power LED light will illuminate green. The system boots up, and displays the lock screen. Slide the Lock icon to the left to enter the MaxiIM Job Menu or slide to the right to unlock.



Figure 3-1 Sample Job Menu

1. Application Buttons
2. Locator and Navigation Buttons
3. Status Icons

NOTE







The tablet screen is locked by default when first powered on. It is recommended to lock the screen to protect the information in the system and reduce the power consumption.



The touch screen navigation is menu driven enabling quick access to functions and features by tapping on options headings and answering dialog windows. Detailed descriptions of the menu structures are found in the application chapters.

Application Buttons

Descriptions of the tool applications are displayed in the table below.

Table 3-1 Applications







Button	Name	Description
	IMMO	Accesses IMMO functions menu. See IMMO on page 28 for details.
	Programming	Accesses Programming functions menu. See Programming on page 48 for details.
	Diagnostics	Accesses diagnostic functions menu. See Diagnostics on page 60 for details.
	Service	Accesses special functions menu. See Service on page 80 for details.
	Update	Checks for the latest update available for the MaxiIM system, and performs updates. See Update on page 98 for details.
	Settings	Accesses MaxiIM system settings menu and general tablet menu. See Settings on page 102 for details.
	Remote Desk	Configures the unit to receive remote support using the TeamViewer application program. See Remote Desk on page 110 for details.







Button	Name	Description
	Data Manager	Accesses the organization system for saved data files. See Data Manager on page 112 for details.
	Shop Manager	Accesses Shop manager database to store workshop, customer information and vehicle test history. See Shop Manager on page 117 for details.
	VCI Manager	Establishes and manages BT connection with the MaxiFlash. See VCI Manager on page 125 for details.

Locator and Navigation Buttons

Operations of the Navigation buttons at the bottom of the screen are described in the table below:

Table 3-2 Locator and Navigation Buttons

Button	Name	Description
	Locator	Indicates the location of the screen. Swipe the screen left or right to view the previous or next screen.
	Back	Returns to the previous screen.
	Android Home	Returns to Android System's Home screen.
	Recent Apps	Displays a list of applications that are currently in use. Tap an app icon to launch. To remove an app, swipe it to the top or bottom.
	Chrome	Launches the Android built-in browser.
	Camera	Takes a screenshot with long press when you want to save the displayed information.

Button	Name	Description
	Brightness/ Volume	Adjust the brightness and volume of the tool.
	MaxiIM Home	Returns to MaxiIM Job Menu.
	VCI	Returns to VCI Manager screen.
	IMMO Shortcut	Returns to the IMMO screen.
	Diagnostic Shortcut	Returns to the Diagnostic screen.
	Service Shortcut	Returns to the Service screen.

System Status Icons





As the Display Tablet is working with the Android operating system, you may refer to Android documents for more information.



By up sliding the bottom right corner, a Shortcuts Panel will be displayed, on which you are allowed to set various system settings of the tablet. Operations of each button on the panel are described in the table below:

NOTE

The shortcuts buttons will be highlighted when enabled and dimmed when disabled.

Table 3-3 Shortcuts Panel Buttons

Button	Name	Description
	Calculator	Launches calculator when pressed.
	Clock	Launches clock when pressed.
	Bluetooth	Launches Bluetooth when pressed.
	Wi-Fi	Enables/disables Wi-Fi when pressed.

	Airplane Mode	Enables/disables Airplane Mode when pressed.
	System Settings	Launches the Android System Settings screen when pressed.

Powering Down

All vehicle communications must be terminated before shutting down the Display Tablet. A warning message displays if you attempt to shut down the Display Tablet when it is communicating with the vehicle. Forcing a shut-down while communicating may lead to ECM problems on some vehicles. Please exit the Diagnostics application before powering down.

➤ To power down the display tablet

1. Long press the Lock/Power Button.
2. Tap **Power off** option.
3. Tap **OK**, the tablet will turn off in a few seconds.

Reboot System

In case of system crash, long press the Lock/Power button and tap **Reboot** option to reboot the system.

4 IMMO

The IMMO application provides Smart Mode and Expert Mode to guide technicians performing IMMO related functions, including Key Learning, Remote Control Learning, Remote Control Add, etc.

Establish Vehicle Communication

The IMMO operations require connecting the MaxiIM IM608 tablet to the test vehicle through the MaxiFlash using the main cable and the included USB cable (2m). To establish proper vehicle communication to the tablet, you need to perform the following steps:

1. Connect the MaxiFlash to the vehicle's DLC for both communication and power source.
2. Connect the MaxiFlash to the tablet via BT pairing, or USB connection.
3. When the above steps are completed, check the VCI navigation button at the bottom bar on the screen, if a green check displays at the lower right corner, the MaxiIM IM608 is ready to start vehicle diagnosis.

Vehicle Connection

The method used to connect the MaxiFlash to a vehicle's DLC depends on the vehicle's configuration as follows:

- A vehicle equipped with an On-board Diagnostics Two (OBD II) management system supplies both communication and 12-volt power through a standardized J-1962 DLC.
- A vehicle not equipped with an OBD II management system supplies communication through a DLC connection, and in some cases supplies 12-volt power through the cigarette lighter receptacle or a connection to the vehicle battery.

OBD II Vehicle Connection

This type of connection only requires the main cable without any additional adapter.

➤ **To connect to an OBD II vehicle**

1. Connect the main cable's female adapter to the Vehicle Data Connector on the MaxiFlash, and tighten the captive screws.
2. Connect the cable's 16-pin male adapter to the vehicle's DLC, which is generally located under the vehicle dashboard.

🔗 **NOTE**

The vehicle's DLC is not always located under the dashboard; refer to the user manual of the test vehicle for additional connection information.

Non-OBD II Vehicle Connection

This type of connection requires both the main cable and a required OBD I adapter for the specific vehicle being serviced.

There are three possible conditions for Non-OBD II vehicle connection:

- DLC connection supplies both communication and power.
- DLC connection supplies communication and power is to be supplied via the cigarette lighter connection.
- DLC connection supplies communication and power is to be supplied via connection to the vehicle battery.

➤ **To connect to a Non-OBD II Vehicle**

1. Connect the main cable's female adapter to the Vehicle Data Connector on the MaxiFlash, and tighten the captive screws.
2. Locate the required OBD I adapter and connect its 16-pin jack to the main cable's male adapter.
3. Connect the attached OBD I adapter to the vehicle's DLC.

🔗 **NOTE**

Some adapters may have more than one adapter or may have test leads instead of an adapter. Whatever the case, make the proper connection to the vehicle's DLC as required.

➤ **To connect the cigarette lighter**

1. Plug the DC power connector of the cigarette lighter into the DC power supply input port on the device.
2. Connect the male connector of the cigarette lighter into the vehicle's cigarette lighter receptacle.

 **NOTE**

After the MaxiFlash is successfully connected to the vehicle, the Power LED on the device illuminates, and a brief beep sound will be heard.

VCI Connection

After the MaxiFlash is properly connected to the vehicle, the Power LED on the MaxiFlash illuminates solid green, and is ready to establish communication with the tablet.

The Wireless Diagnostic Interface supports two communication methods with the tablet: BT and USB.

Pairing Up via BT

Among all methods, BT pairing is recommended as the first choice for the communication between the tablet and the MaxiFlash. The working range for BT communication is about 210 feet (70 m); this means you can perform key programming and vehicle diagnosis freely around the workshop with greater convenience.

If you use more than one MaxiFlash to connect to the test vehicles when customers are many, you can perform key programming and vehicle diagnosis on various vehicles conveniently, by pairing the tablet separately to each of the MaxiFlash connected to the different test vehicles, via BT, without the need to repeat the plugging and unplugging procedure, which is unavoidable through traditional wired connection, thus saves you more time and provides more efficiency.

➤ **To pair up the tablet with the MaxiFlash via BT**

1. If not already done, power up the tablet.
2. Select the **VCI Manager** application from the MaxiIM Job Menu.
3. When the **VCI Manager** application is opened, the device

automatically starts scanning for available VCI devices around for BT pairing. The found devices are listed in the Setting section on the right side of the screen.

 **NOTE**

If no VCI device is found, this may indicate that the signal strength of the transmitter is too weak to be detected. In this case try to get closer to the device, or reposition the VCI device, and remove all possible objects that may cause signal interference. When done, tap the **Scan** button at the top right corner to start searching again.

4. The VCI device name displays as MaxiFlash suffixed with a serial number. Select the required device for pairing.
5. When pairing is successfully done, the connection status displayed to the right of the device name is shown as Paired.
6. Wait for a few seconds, and the VCI button on the system Navigation bar at the bottom of the screen shall display a green check, indicating the tablet is connected to the MaxiFlash, and is ready to perform vehicle diagnosis.

Refer to [BT Pairing](#) on page 126 for additional information.

USB Cable Connection

The USB cable connection is a simple and quick way to establish communication between the tablet and the MaxiFlash. After properly connecting the USB cable from the tablet to the MaxiFlash, the VCI navigation button at the bottom bar of the screen shows a green check in a few seconds, and the USB LED on the MaxiFlash illuminates solid green, indicating the connection between the devices is successful.

The MaxiIM tablet is now ready to perform key programming and vehicle diagnosis.

No Communication Message

- A. If the tablet is not connected to the MaxiFlash, an “Error” message displays. An “Error” message indicates the tablet is not communicating with the MaxiFlash, and so cannot gain access to the vehicle control module. In this case, you need to do the following check-ups:

- Check if the MaxiFlash is powered on.
 - In case of wireless connection, check if the network is configured correctly, or if the right device has been paired.
 - If during the diagnosis process, communication is suddenly interrupted due to the loss of signal, check if there are any objects that causes signal interruption.
 - Check if the MaxiFlash is properly positioned. It is recommended to put the MaxiFlash with the front side up.
 - Try standing closer to the MaxiFlash to obtain more stable signals, and faster communication speed. In case of wired connection, check the cable connection between the tablet and the MaxiFlash.
 - Check if the green LED on the MaxiFlash is illuminated for BT or USB.
 - Check if the Error LED on the MaxiFlash is on, this may indicate there is a communication error between the devices, in this case try re-establishing the connection again; if this does not work, there may be a hardware problem with the device, in this case contact Autel or local distributor for technical support.
- B. If the MaxiFlash is unable to establish a communication link, a prompt message displays with check instructions. The following conditions are the possible causes for this message to display:
- The MaxiFlash is unable to establish a communication link with the vehicle.
 - You've selected a system for testing that the vehicle is not equipped with.
 - There is a loose connection.
 - There is a blown vehicle fuse.
 - There is a wiring fault on the vehicle, or the data cable or adapter.
 - There is a circuit fault in the data cable or adapter.
 - Incorrect vehicle identification was entered.

Getting Started

Ensure a communication link is established between the test vehicle and the tablet via the main cable, and the XP400 is connected to the tablet with the supplied USB cable.

Vehicle Menu Layout

When the tablet is properly connected to the vehicle, the platform is ready to start vehicle diagnosis. Tap on the **IMMO** application button on the MaxiIM IM608 Job Menu to access the Vehicle Menu.



Figure 4-1 Sample Vehicle Menu



1. Top Toolbar Buttons
2. Manufacturer Buttons

Top Toolbar Buttons

The operations of the toolbar buttons at the top of the screen are listed and described in the table below:

Table 4-1 Top Toolbar Buttons

Button	Name	Description
	Home	Returns to the MaxiIM Job Menu.

	VIN Scan	Displays a dropdown list; tap Auto Detect for auto VIN detection; tap Manual Input to enter VIN manually.
All	All	Displays all the vehicle makes in the vehicle menu.
History	History	Displays the stored test vehicle history records. This option provides you direct access to the previously tested vehicle recorded during previous test sessions. See Vehicle History on page 118.
USA	USA	Displays the USA vehicle menu.
European	Europe	Displays the European vehicle menu.
Asia	Asia	Displays the Asian vehicle menu.
China	China	Displays the Chinese vehicle menu.
	Search	Displays the virtual keyboard to manually enter the specific vehicle make required.

Manufacturer Buttons

To begin, select the manufacturer button of the test vehicle, followed by the vehicle model and year.

Vehicle Identification

The MaxiIM diagnostic system supports four methods for Vehicle Identification.

1. Auto VIN Scan
2. Manual VIN Input
3. Automatic Selection
4. Manual Selection

Auto VIN Scan and Manual VIN Input functions are applicable for IMMO, Diagnostic and Service applications, Automatic Selection and Manual Selection are applicable for Diagnostic and Service applications. In IMMO,

except Auto VIN Scan and Manual VIN Input methods, technicians can also manually select vehicle manufacturer, instrument information step by step to locate the desired IMMO part, but it is a little different from Automatic Selection and Manual Selection. Besides, as Programming does not require connection with the vehicle, therefore, Auto VIN Scan is not applicable for this application, and technicians can manually select the part information follow the onscreen instructions to display the function menu.

Auto VIN Scan

The MaxiIM diagnostic system features the latest VIN-based Auto VIN Scan function to identify vehicles and it is applied to IMMO, Programming, Diagnostic and Service applications. IMMO provides two modes: Smart Mode and Expert Mode, and only Smart Mode can be accessed by using Auto VIN function.

➤ To perform Auto VIN Scan

1. Tap the **IMMO** application button from the MaxiIM Job Menu. The Vehicle Menu displays.
2. Tap the **VIN Scan** button on the top toolbar to open a dropdown list.



Figure 4-2 Sample Auto VIN Screen

3. Select **Auto Detect**. Once the test vehicle is successfully identified, the screen will display the vehicle profile. Tap **OK** at the bottom right

to confirm the vehicle profile. If the VIN does not match with the test vehicle's VIN, enter VIN manually or tap **Read** to acquire VIN again.

4. Tap **Yes** to confirm the vehicle profile or **NO** if the information is not correct.
5. The tool establishes communication with the vehicle and reads the IMMO control unit information.

Manual VIN Input

For vehicles that not supporting the Auto VIN Scan function, you may manually enter the vehicle VIN.

➤ To perform Manual VIN Input

1. Tap the **IMMO** application button from the MaxiIM Job Menu. The Vehicle Menu displays.
2. Tap the **VIN Scan** button on the top toolbar.
3. Select **Manual Input**.
4. Tap the input box and enter the correct VIN.



Figure 4-3 Sample Enter VIN Screen

5. Tap **Done** to complete or tap **Cancel** to exit Manual Input.

Automatic Selection

The Auto VIN Scan can be selected after selecting the test vehicle manufacturer.

➤ To perform Automatic Selection

1. Tap the **Diagnostic** application button from the MaxiIM Job Menu. The Vehicle Menu displays.
2. Tap the manufacturer button of the test vehicle.
3. Tap **Automatic Selection** and the VIN information will be automatically acquired. Follow the on-screen instruction to display the function screen.

Manual Selection

When the vehicle's VIN is not automatically retrievable through the vehicle's ECU, or the specific VIN is unknown, the vehicle can be manually selected.

This mode of vehicle selection is menu driven, repeat the first two steps from the automatic selection operation and tap **Manual Selection**. Through a series of on-screen prompts and selections, the test vehicle is chosen. If needed, press the **Back** button at the bottom right corner of the screen to return to the previous screen.

Navigation

Navigating the IMMO interface and selecting test are discussed in this section.

IMMO Screen Layout

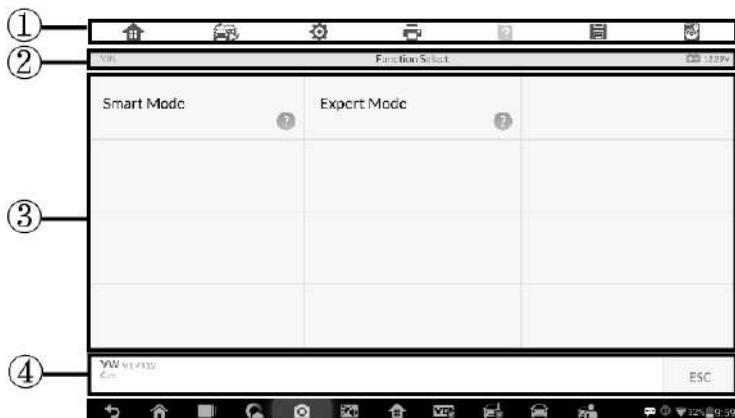

Figure 4-4 Sample Mode Selection Screen



The IMMO screens typically include four sections.





1. Operation Toolbar
2. Status Information Bar
3. Main Section
4. Functional Buttons

Operation Toolbar

The Operation Toolbar contains a number of buttons such as print and save. The table below provides a brief description of the operations.

Table 4-2 Operation Toolbar Buttons

Button	Name	Description
	Home	Returns to the MaxiIM Job Menu.
	Vehicle Swap	Exits the function session of the currently identified test vehicle and returns to the vehicle menu screen.

Button	Name	Description
	Settings	Opens the settings screen. See Settings on page 102.
	Print	Prints a copy of the displayed data. See Printing Setting for additional information on page 104.
	Help	Displays operational instructions or tips.
	Save	Tap this button to open a sub menu, tap Save This Page to take a screenshot. All saved data is stored in the Data Manager application for later reviews. See Data Manager Operations on page 112.
	Data Logging	Records the communication data and ECU information of the test vehicle. The saved data can be reported and sent to the technical center via the Internet. You can go to the Support application to follow up the processing progress, see Data Logging on page 116 for detailed information.

➤ **To print data**

1. Tap the **IMMO** application button from the MaxiIM Job Menu. The **Print** button on the toolbar is available throughout the IMMO operations.
2. Tap **Print**. A drop-down menu displays. Tap **Print This Page** to print a screenshot of the current screen.
3. A temporary file will be created and send to the connected computer for printing.
4. When the file is transferred successfully, a confirmation message displays.

➤ **To submit Data Logging reports**

1. Tap the **IMMO** application button from the MaxiIM Job Menu. The

Data Logging button on the toolbar is available throughout the IMMO operations.

2. Tap the **Data Logging** button. The button displays blue during the active recording process.
3. Tap the **Data Logging** button again to end recording. A submission form will display for inputting of report information.
4. Tap the **Send** button to submit the report form via the Internet. A confirmation message displays when the report has been successfully sent.

Status Information Bar

The Status Information Bar at the top of the Main Section displays the following items:

1. Menu Title – displays the menu heading of the Main Section.
2. Voltage Icon – displays the vehicle's voltage status.

Main Section

The Main Section of the screen varies depending on the stage of operations. The Main Section can display vehicle identification selections, the main menu, test data, messages, instructions and other information. In this case, it shows the two modes IMMO provides: Smart Mode and Expert Mode.

Functional Buttons

The displayed Functional Buttons vary depending on the stage of operations. Functional buttons can be used to navigate menus, to save or clear data, to exit scanning and to perform a number of other control functions. The use of these buttons will be discussed in detail in the following sections of the corresponding test operations.

Screen Messages

Screen messages appear when additional input is needed before proceeding. There are three main types of on-screen messages: Confirmation, Warning, and Error.

Confirmation Messages

This type of messages usually displays as an “Information” screen to inform the user that a selected action cannot be reversed or when an action has been initiated and confirmation is needed to continue.

When a user-response is not required to continue, the message displays briefly.

Warning Messages

This type of messages displays a warning that a selected action may result in an irreversible change or loss of data. An example of this type of message is the “Erase Codes” message.

Error Messages

Error messages display when a system or procedural error has occurred. Examples of possible errors include a disconnection or communication interruption.

Making Selections

The IMMO application is a menu driven program that presents a series of choices. As a selection is made, the next menu in the series displays. Each selection narrows the focus and leads to the desired test. Tap the screen to make menu selections.

IMMO

The IMMO application requires a data link to the IMMO electronic control system of the test vehicle for diagnosis via OBD II connection. The application retrieves vehicle IMMO information and performs IMMO related functions, including Key Learning, Remote Control Learning, Remote Control Add, etc.

There are two options available when accessing the IMMO section:

1. Smart Mode – accesses to a function menu where each function is configured as a smart guide system.
2. Expert Mode – accesses to a function menu where each function is separated from each other.

After a mode is selected and the tablet establishes communication with the vehicle, the corresponding function menu or selection menu displays.

Smart Mode

The Smart Mode provides guided functions with step-by-step instructions. Once the test vehicle is identified, a vehicle profile will display, select **Yes** to continue.



Figure 4-5 Sample Vehicle Information Screen

The tablet will access the vehicle IMMO ECU to read IMMO related information. Press **OK** to continue. Then the vehicle key status will display.

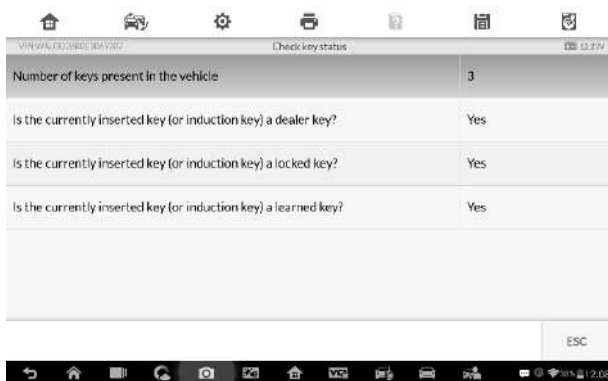

Figure 4-6 Sample Check Key Status Screen

Read the vehicle key status carefully and press **OK** to display the function menu.

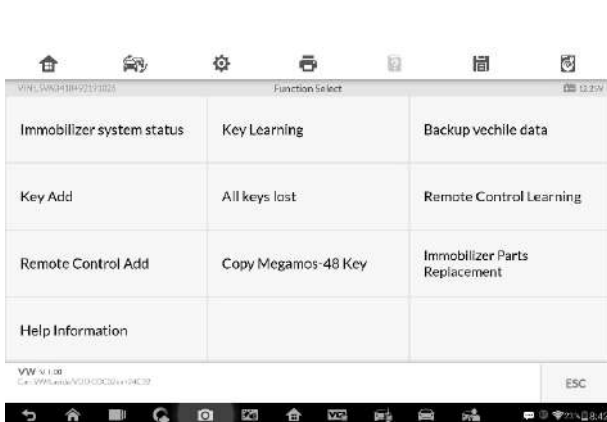

Figure 4-7 Sample Function Menu in Smart Mode

The functions vary by IMMO parts, please follow the onscreen instructions to select the correct IMMO part.

Take **Key Learning** as an example.

1. Select **Key Learning** from the function menu. The tablet will automatically start to read IMMO data.

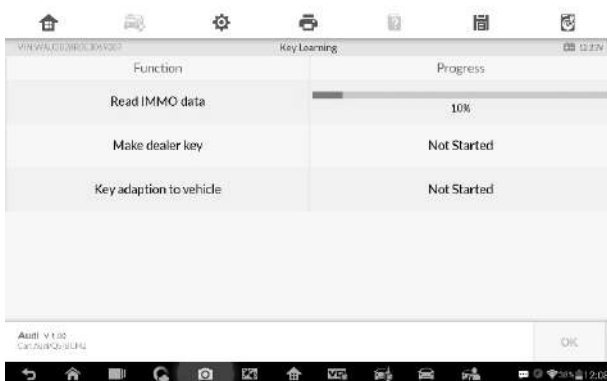

Figure 4-8 Sample Key Learning Screen 1

- When Read IMMO data completes, the tablet will prompt a “Do you need to make dealer key?” message, select **Yes** to confirm, or select **NO** to quit the operation.

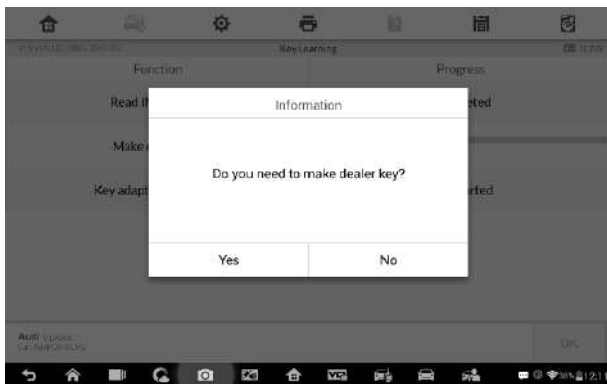

Figure 4-9 Sample Key Learning Screen 2

- Follow the onscreen instruction to place a Blank Key in the XP400 key slot and press **OK** to continue.
- If the new key is blocked, the tablet will ask if you want to unlock the key, select **Yes** to continue, or select **NO** to quit the operation.
- A “Make dealer key success!” message displays when the process is completed successfully.
- Then the tablet will automatically move to the next step, Key adaption to vehicle, and the following message will prompt up.
- Make selections according to the test vehicle.
- Input the numbers of the keys to be learned and press **OK** to continue.



Figure 4-10 Sample Key Learning Screen 3

9. Follow the onscreen instructions to insert the key to be learned into the vehicle ignition switch.

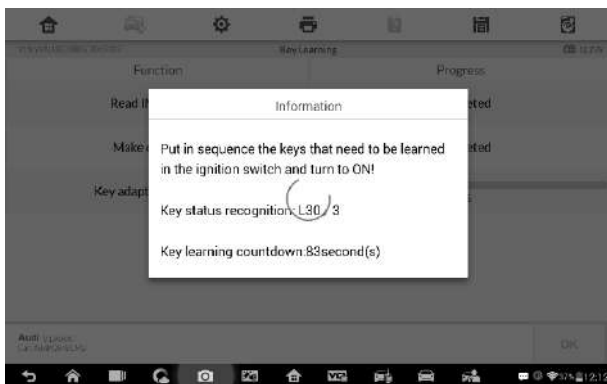

Figure 4-11 Sample Key Learning Screen 4

10. When Key Learning is completed successfully, the following screen displays. Press **OK** to exit the function.

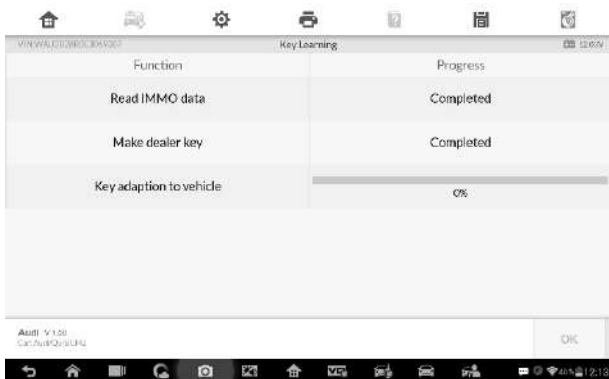

Figure 4-12 Sample Key Learning Screen 5

Expert Mode

Expert Mode provides skilled technicians a convenient way to perform individual IMMO functions they need. All the function options in this mode are separated segments. If needed, technicians can only perform one segment function instead of a whole process provided in Smart Mode.

1. Select **Expert Mode** from the mode selection screen. The screen displays individual IMMO functions for selection.

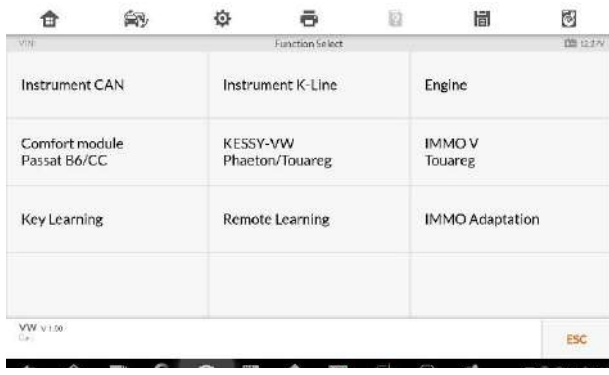

Figure 4-13 Sample Expert Mode Function Menu

2. For Instrument CAN and Engine, the tool supports auto detect.

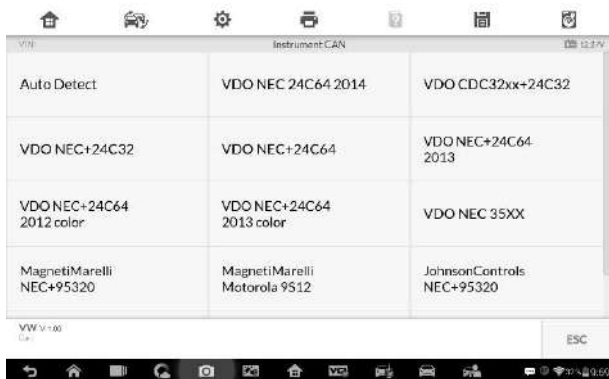

Figure 4-14 Sample Auto Detect Screen

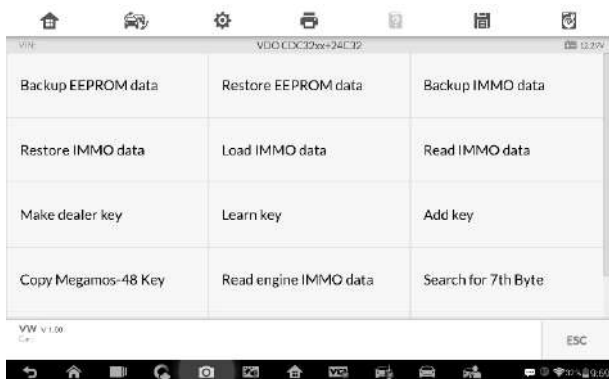

Figure 4-15 Sample Function Screen

3. Tap **Auto Detect** and the screen displays the functions menu.

Read IMMO Data

Select **Read IMMO Data** from the function menu. The tablet will start to read IMMO information. Review the data and press **OK** to exit.

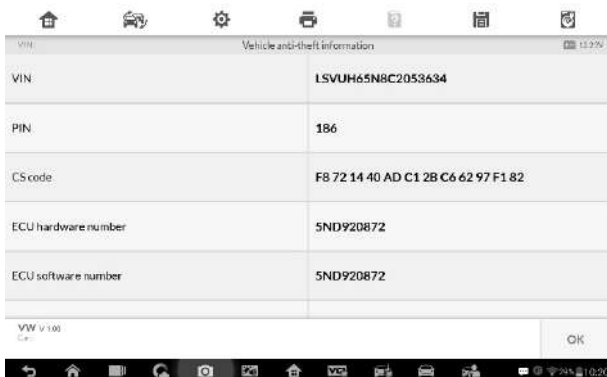

Figure 4-16 Sample Read IMMO Data Screen

After the IMMO data is read, technicians can perform other IMMO functions with the read data in Expert Mode.

Learn Key

1. Select **Learn Key** from the function menu. The tool will confirm whether the vehicle has Kessy, tap Yes or No according to the situation to continue.

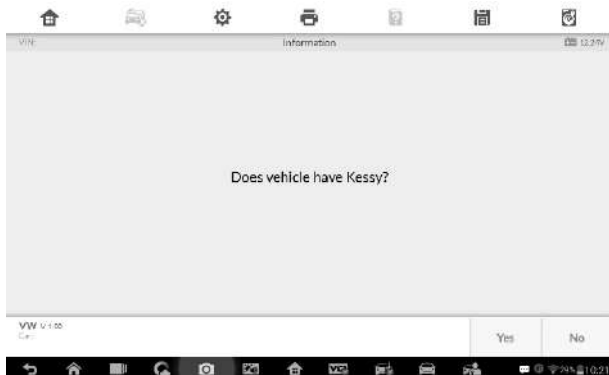

Figure 4-17 Sample Kessy Confirm Screen

2. Enter the number of keys to be learned.



Figure 4-19 Sample Learn Key Screen 1

3. Insert in sequence the keys that need to be learned into the vehicle. The keys should be changed at an interval of less than 5s.

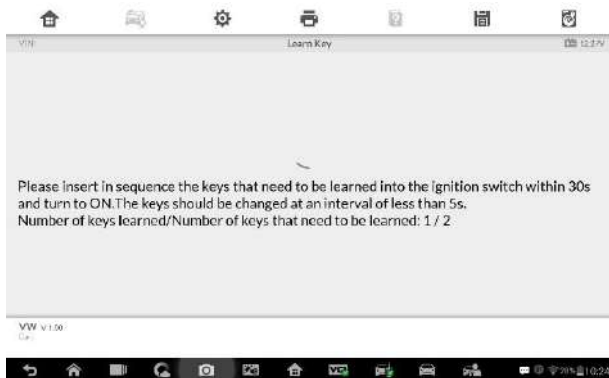

Figure 4-18 Sample Learn Key Screen 2

4. Once the keys are successfully learned, the screen displays the message “Key learning completed”, tap **OK** to exit.

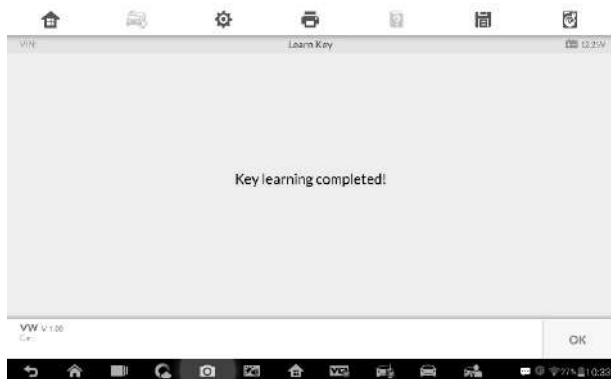

Figure 4-20 Sample Learn Key Screen 3

5 Programming

The Programming application requires connection between the tablet and the XP400, and no vehicle connection is required. This application can access the key chip, read, retrieve and write key information, as well as other key related functions.

Programming

Select the vehicle manufacturer in the vehicle menu, and then follow the onscreen instructions to select the instrument information to display the function menu.

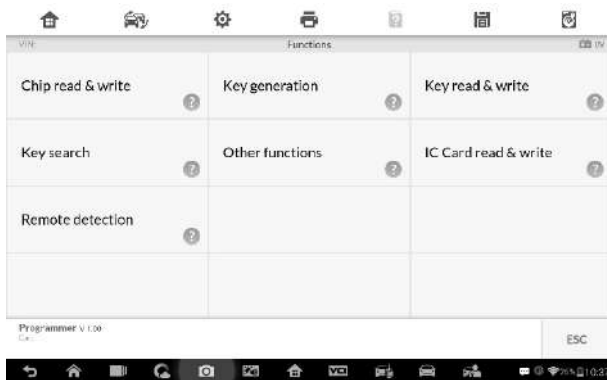

Figure 5-1 Sample Programming Function Menu

Chip Read & Write

1. Select **Chip Read & Write** from the menu.
2. Select the chip type if needed. In this example, select **EEPROM**.



Figure 5-2 Sample Select Chip Type Screen

3. The screen displays the types of EEPROM supported. Select the right type.



Figure 5-3 Sample Chip Type Screen

4. Select **Read Operation** on the next menu.

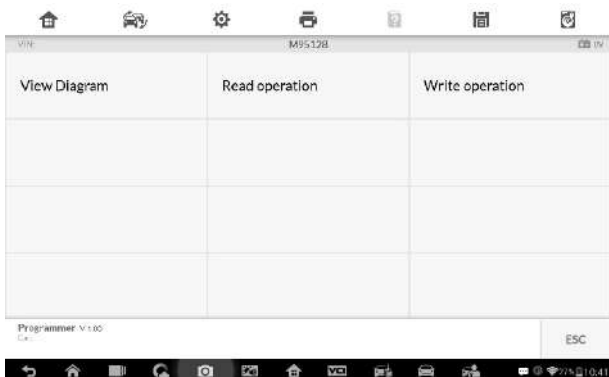

Figure 5-4 Sample Operations Menu

5. The chip data screen displays. Select **Save** to save the data, or select **Cancel** to exit.

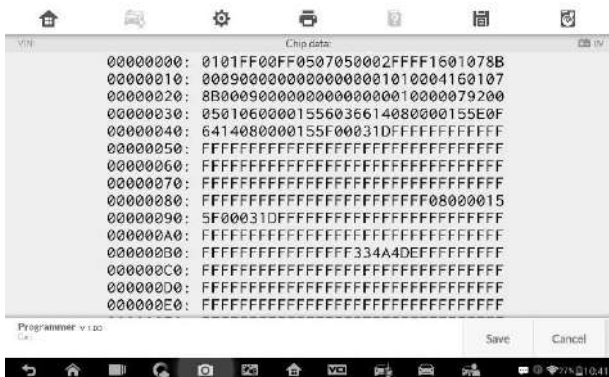

Figure 5-5 Sample Read Operation Screen

6. Type the file name and select Confirm, the chip data will be saved on the tablet. And a “File saved successfully.” message displays.

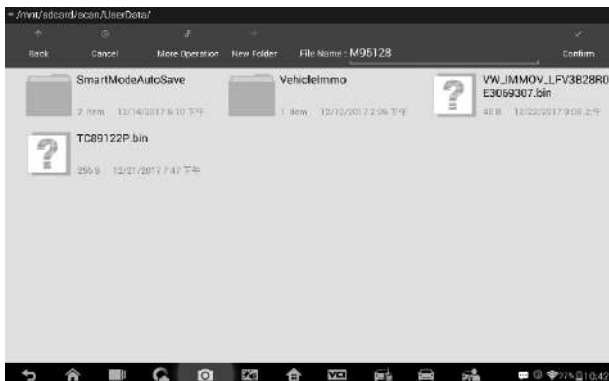

Figure 5-6 Sample Save Data Screen

7. Select **Write Operation** from the operations menu. The tablet will open the default folder, select the saved data and click **Confirm** to write it into a black chip. And a “Chip written successfully.” message displays.

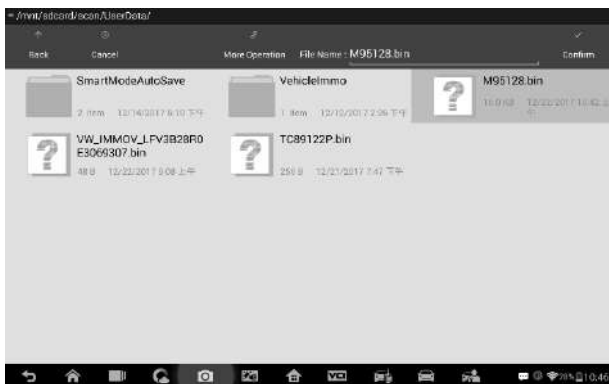

Figure 5-7 Sample Write Operation Screen

Key Read & Write

1. Select **Key Read & Write** from the menu.
2. Select the key type or automatic detection. Please note that automatic

detection does not support detection of IR key.



Figure 5-8 Sample Key Select Screen

- Once the key type is successfully detected, the screen displays the key type, tap **OK** to enter the operation interface.



Figure 5-9 Sample Key Type Screen

- The screen displays the supported functions which usually include Read out key ID, Read out key information, Write page.

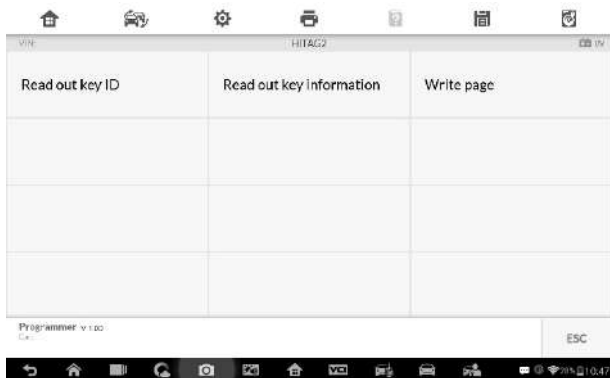

Figure 5-10 Sample Functions Screen

5. Tap **Read out key ID** to read the key ID.

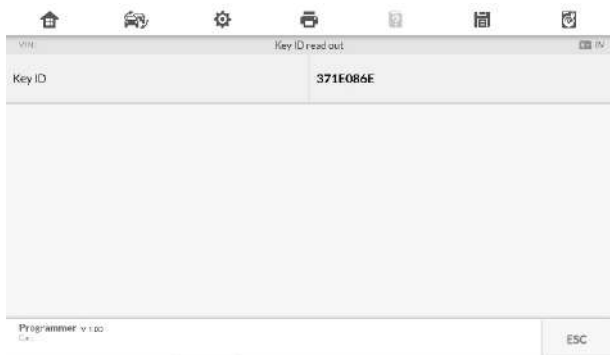

Figure 5-11 Sample Key ID Screen

6. Tap **Read out key information** to read the information.



Figure 5-12 Sample Read Out Key Information Screen



Figure 5-103 Sample Write Page Data Screen

7. Tap **Write page data** to write the data.

Remote Detection

1. Tap **Remote Detection** from the menu, the function menu displays.

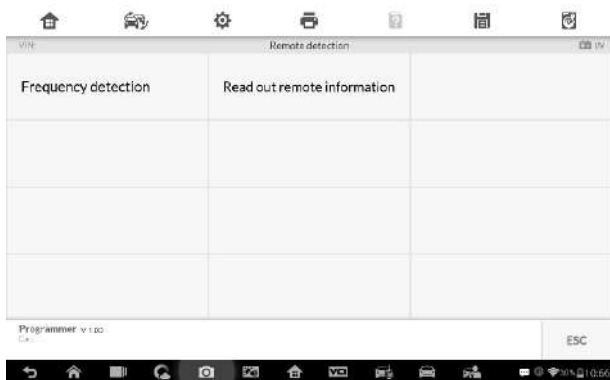

Figure 5-114 Sample Remote Detection Function Screen

- Put the key into suitable area and press down any key button. The screen displays the frequency of the key.



Figure 5-125 Sample Frequency Display Screen

6 Diagnostics

The Diagnostics application can retrieve ECU information, read & erase DTCs, and view live data. The Diagnostics application can access the electronic control unit (ECU) for various vehicle control systems, including engine, transmission, antilock brake system (ABS), airbag system (SRS).

Diagnosis

The Diagnostics application enables a data link to the electronic control system of the test vehicle for vehicle diagnosis via OBD II connection. The application performs functional tests, retrieves vehicle diagnostic information such as trouble and event codes and live data for various vehicle control systems, such as engine, transmission, and ABS.

There are two options available when accessing the Diagnosis section:

1. Auto Scan – starts auto scanning for all the available systems on the vehicle.
2. Control Units – displays a selection menu of all available control units of the test vehicle.

After a section is made and the tablet establishes communication with the vehicle, the corresponding function menu or selection menu displays.

Auto Scan

The Auto Scan function performs a comprehensive scanning over all the ECUs in the vehicle to locate systems' faults and retrieve DTCs. The sample operation interface of Auto Scan displays as below:

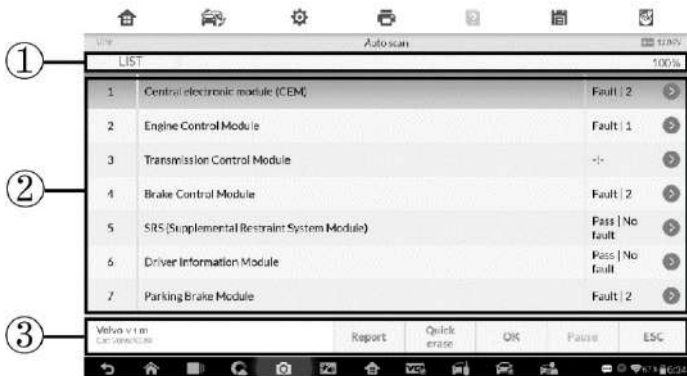

Figure 6-1 Sample Auto Scan Operation Screen

1. Navigation Bar
2. Main Section
3. Functional Buttons

Navigation Bar

List Tab – displays the scanned data in list format.

Progress Percentage – indicates the test progress.

Main Section

Column 1 – displays the sequence numbers.

Column 2 – displays the scanned systems.

Column 3 – displays the diagnostic indicators describing test results.

These indicators are defined as follows:

- ❖ **-!-**: Indicates that the scanned system may not support the code reading function, or there is a communication error between the Display Tablet and the control system.
- ❖ **-?-**: Indicates that the vehicle control system has been detected, but the Display Tablet cannot accurately locate it.

- ✧ **Fault(s) | #:** Fault(s) indicates there is/are detected fault code(s) present; “#” indicates the number of the detected faults.
- ✧ **Pass | No Fault:** Indicates the system has passed the scanning process and no fault has been detected.

Column 4 – to perform further diagnosis or testing on a specific system item, tap the  button to the right of that item. A Function Menu screen will display.

Functional Buttons

A brief description of the operations of the Auto Scan’s Functional Buttons’ are displayed in the table below.

Table 6-1 Functional Buttons in Auto Scan

Name	Description
Report	Displays the diagnostic data in the report form.
Quick Erase	Deletes codes. A warning message screen will display to inform you of possible data loss when this function is selected.
OK	Confirms the test result. Continues to the system diagnosis after the required system is selected by tapping the item in the Main Section.
Pause	Suspends scanning and it will change to Continue button after tapping.
ESC	Returns to the previous screen or exits Auto Scan.

Control Units

Manually locate a required control system for testing through a series of selection choices. Follow the menu driven procedures and make proper selection; the application guides the user to the proper diagnostic function menu based on selections.

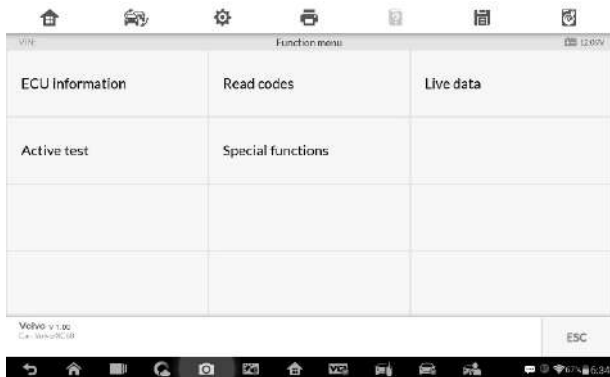

Figure 6-2 Sample Function Menu Screen

The Function Menu options vary slightly for different vehicles. The function menu may include:

- **ECU Information** – provides the retrieved ECU information in detail. An information screen opens upon selection.
- **Read Codes** – displays detailed information of DTC records retrieved from the test vehicle's ECU.
- **Erase Codes** – erases DTC records and other data from the test vehicle's ECU.
- **Live Data** – retrieves and displays live data and parameters from the test vehicle's ECU.
- **Active Test** – provides specific subsystem and component tests. This selection may appear as *Actuators*, *Actuator Test*, or *Function Tests* and the tests options vary by vehicle manufacturer and model.
- **Special Functions** – provides component adaptation or variant coding functions for custom configurations, and also allows you to reprogram adaptive values for certain components after making repairs. Depending on the test vehicle, this selection may sometimes appear as *Control Unit Adaptations*, *Variant Coding*, *Configuration* or something similar.

NOTE

Toolbar functions such as saving and printing of test results can be performed throughout diagnostic testing. Data logging and access to help information are also available.

➤ **To perform a diagnostic function**

1. Establish communication with the test vehicle.
2. Identify the test vehicle by selecting from the menu options.
3. Select the **Diagnosis** section.
4. Locate the required system for testing by **Auto Scan** or through menu driven selections in **Control Units**.
5. Select the desired diagnostic function from the **Function Menu**.

ECU Information

This function retrieves and displays the specific information for the tested control unit, including unit type, version numbers and other specifications. The sample ECU Information screen displays as below:

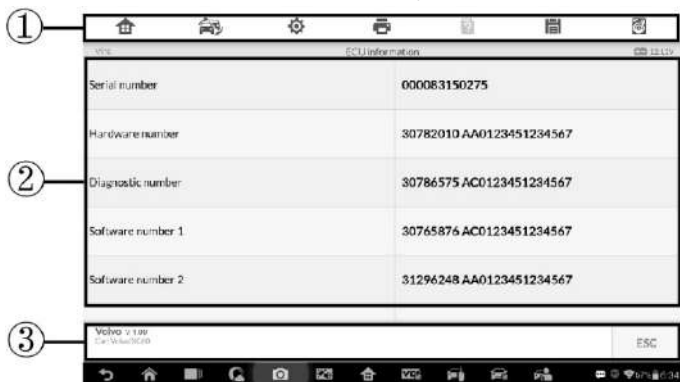

Figure 6-3 Sample ECU Information Screen

1. Diagnostics Toolbar Buttons – see [Table 4-2 Operation Toolbar Buttons](#) on page 38 for detailed descriptions of the operations for each button.
2. Main Section – the left column displays the item names; the right column shows the specifications or descriptions.
3. Functional Button – **ESC** (or **Back**) button is available; tap it to exit after viewing.

Read Codes

This function retrieves and displays the DTCs from the vehicle's control system. The Read Codes screen varies for each vehicle being tested. On some vehicles, freeze frame data can also be retrieved for viewing. The sample Read Codes screen displays as below:

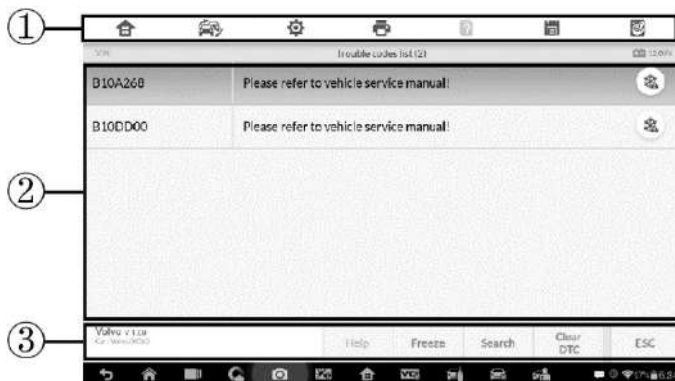

Figure 6-4 Sample Read Codes Screen

1. Diagnostics Toolbar Buttons – see [Table 4-2 Operation Toolbar Buttons](#) on page 38 for detailed descriptions of the operations for each button.
2. Main Section
 - Code Column – displays the retrieved codes from the vehicle.
 - Status Column – indicates the status of the retrieved codes.
 - Description Column – detailed descriptions for the retrieved codes.
 - Snowflake Icon – only displays when freeze frame data is available for viewing; selecting this icon will display a data screen, which looks and behaves similar to the Read Codes screen.
3. Functional Button
 - Help – tap to view fault code information, including fault description, condition for fault identification, and driver information.
 - Freeze frame – tap to view the freeze frame data.
 - Search – tap to search related fault code information on Google.
 - ESC – tap to return to the previous screen or exit the function.

Erase Codes

After reading the retrieved codes from the vehicle and certain repairs have been carried out, you can decide to erase the codes from the vehicle using this function. Before performing this function, make sure the vehicle's ignition key is in the ON (RUN) position with the engine off.

➤ **To erase codes**

1. Tap **Erase Codes** from the Function Menu.
2. A warning message displays to advice of data loss if this function is completed.
 - a) Tap **Yes** to continue. A confirming screen displays when the operation is successfully done.
 - b) Tap **No** to exit.
3. Tap **ESC** on the confirming screen to exit Erase Codes.
4. Perform the Read Codes function again to check if codes have been erased successfully.

Live Data

When this function is selected, the screen displays the data list for the selected module. The items available for any control module vary from one vehicle to another. The parameters display in the order that they are transmitted by the ECM, so expect variation between vehicles.

Gesture scrolling allows for quick movement through the data list. Use one or two fingers to swipe the screen up or down to locate the data you want. The figure below shows a typical Live Data screen:



Figure 6-5 Sample Live Data Screen

1. Diagnostics Toolbar Buttons – taps the drop-down button at the top center of the screen and the toolbar buttons will display. See [Table 4-2 Operation Toolbar Buttons](#) on page 38 for detailed descriptions of the operations for each button.
2. Main Section
 - Name Column – displays the parameter names.
 - a) Check Box – tap the check box on the left side of the parameter name to make item selection. Tap the check box again to deselect the item.
 - b) Drop-down Button – tap the drop-down button on the right side of the parameter name to open a sub menu, providing data display mode options.
 - Value Column – displays the values of the parameter items.
 - Unit Column – displays the unit for the parameters.
 - To change the unit mode, tap the **Setting** button on the top toolbar and select a required mode. See [Unit](#) on page 102 for more information.
3. Display Mode

There are four types of display modes available for data viewing. Select the proper mode for the diagnostic purpose.

Tap the drop-down button on the right side of the parameter name to open a sub menu. There are four buttons to configure the data display mode, and a Help button for access to additional information.

Each parameter item displays the selected mode independently.

- 1) Analog Gauge Mode – displays the parameters in form of an analog meter graph.
- 2) Text Mode – this is the default mode which displays the parameters in texts and shows in list format.

 **NOTE**

Status parameters, such as a switch reading, can primarily be viewed in text form such as ON, OFF, ACTIVE, and ABORT. Whereas, value parameters, such as a sensor reading, can be displayed in text mode and additional graph modes.

- 3) Waveform Graph Mode – displays the parameters in waveform graphs.

When this mode is selected, three control buttons display on the right side of the parameter item for manipulation of display status.

- Text Button – resumes Text Display Mode.
- Scale Button – changes the scale values that are displayed below the waveform graph. There are four scales available: x1, x2, x4 and x8.
- Zoom-in Button – tap once to display the selected data graph in full screen.
 - ◇ Edit Button – tap this button to open an edit window, on which you can set the waveform color and the line thickness displayed for the selected parameter item.
 - ◇ Scale Button - changes the scale values, which are displayed below the waveform graph. There are four scales available: x1, x2, x4 and x8.
 - ◇ Zoom-out Button – exits full screen display.
- 4) Digital Gauge Mode – displays the parameters in form of a digital gauge graph.

Full Screen Display – this option is only available in the waveform graph mode, and primarily used in Graph Merge status for data comparison.

Under this mode, there are three control buttons available on the top right side of the screen.

➤ **To edit the waveform color and line thickness in a data graph**

1. Select 1 to 3 parameter items to display in Waveform Graph mode.
 2. Tap the **Zoom-in Button** on the right to display the data graph in full screen.
 3. Tap the **Edit Button**, an edit window appears.
 4. Select a parameter item on the left column.
 5. Select a desired sample color from the middle column.
 6. Select a desired sample line thickness from the right column.
 7. Repeat step 3-5 to edit the waveform for each parameter item.
 8. Tap **Done** to save the setting and exit, or tap **Cancel** to exit without saving.
4. Functional Buttons

The operations of available functional buttons on Live Data screen are described below:

Back – returns to previous screen or exits the function.

Record – starts recording the retrieved live data; the recorded data is then stored as a video clip in the Data Manager application for future reviews. This function can be triggered automatically at preset threshold value or values may be set manually. The triggering mode and record duration can be configured in the Setting mode of Live Data.

Freeze frame – displays the retrieved data in freeze frame mode.

- Previous Frame – displays previous frame if the freeze frame data.
- Next Frame – advances to the next frame in the freeze frame data.

Clear Data – clears all previously retrieved parameter values at a particular cutting point.

To Top – moves a selected data item to the top of the list.

Graph Merge – taps this button to merge selected data graphs (for Waveform Graph Mode only). This function is useful for comparisons between different parameters.

NOTE

In this mode, Graph Merge can only display up to three parameter items.

- To cancel Graph Merge mode, tap the drop-down button on the right side of the parameter name, and select a data display mode.

Show – taps this option to switch between the two options; one displays the selected parameter items, the other displays all the available items.

Setting – taps this button to access setting screen to set the trigger mode, recording duration and threshold values for data recording, and define other control settings.

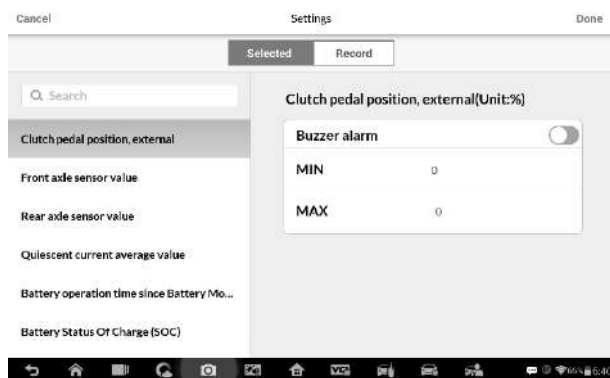

Figure 6-6 Sample Setting Mode in Live Data

There are four navigation buttons on top of the **Setting** mode screen.

- **Selected Button** – displays the configuration screen on which you can set the threshold values, an upper limit and a lower limit, for triggering the buzzer alarm. This function is only applied to the Waveform Graph display mode.
 - a) **MIN** – taps to open a virtual keyboard, allowing you to enter the required lower limit value.
 - b) **MAX** – taps to open a virtual keyboard, allowing you to enter the required upper limit value.
 - c) **Buzzer Alarm** – switches the alarm on and off.



➤ **To set threshold limits for the parameter values**

1. Tap the **Setting** functional button at the bottom of the Live Data screen.
2. Tap the **Selected** navigation button.
3. Select a parameter item on the left column, or enter the item name in the Search bar.
4. Tap on the right side of the **MIN** button, and enter the required minimum value.
5. Tap on the right side of the **MAX** button, and enter the required maximum value.
6. Tap the **ON/OFF** button on the right side of the Buzzer Alarm button to turn it on or off.
7. Tap **Done** to save the setting and return to the Live Data screen; or tap **Cancel** to exit without saving.

If the threshold limits are successfully set, two horizontal lines will appear on each of the data graphs (when Waveform Graph Mode is applied) to indicate the alarming point. The threshold lines are shown in different colors from the waveform of the parameters for distinction.

- **Record Button** – displays the configuration screen for Record Setting, on which you can set the trigger type, duration and trigger point for the data recording function.
 - a) **Trigger Type** – sets the trigger mode for data recording, mainly of two kinds: Manual and Auto. There are four options available:
 - 1) **Manual** – allows you to manually start and stop data recording
 - 2) **DTC** – auto triggers data recording when any DTC is detected
 - 3) **DTC Check Mode** – auto triggers data recording when certain pre-selected DTC types are detected
 - 4) **Parameter** – auto triggers data recording when any parameter value reaches the preset threshold
 - b) **Duration** – sets the recording time (for Auto trigger mode only)
 - c) **Trigger Point** – reserves a relative percentage of a record length before the data recording start point for reference (for Auto trigger mode only)

➤ To perform setting for live data record

1. Tap the **Setting** functional button at the bottom of the Live Data screen.
 2. Tap the **Record** navigation button.
 3. Tap the  button on the right of **Trigger Type** bar and select the required trigger mode.
 4. Tap the  button on the right of **Duration** bar and select a length of time.
 5. Tap the  button on the right of **Trigger Point** bar and select a relative percentage of a record length to be reserved before the data recording start point.
 6. Tap **Done** to save the setting and return to the Live Data screen; or tap **Cancel** to cancel without saving and exit Setting.
- **Done Button** – confirms and saves the setting, and returns to the Live Data screen.
 - **Cancel Button** – cancels the setting operation, and returns to the Live Data screen.

Active Test

The Active Test function is used to access vehicle-specific subsystem and component tests. Available test vary by vehicle manufacturer, year, and model, and only the available tests display in the menu.

During an active test, the tester outputs commands to the ECU in order to drive the actuators. This test determines the integrity of the system or parts by reading the engine ECU data, or by monitoring the operation of the actuators, such as switching a solenoid, relay, or switch, between two operating states.

Selecting Active Test opens a menu of test options that varies by vehicle make and model. Selecting a menu option activates the test. Follow all screen instructions while performing tests. How and what information is presented on the screen varies according to the type of test being performed. Some toggle and variable control tests display Active Test Controls at the top of the screen with data stream information below, or vice versa.

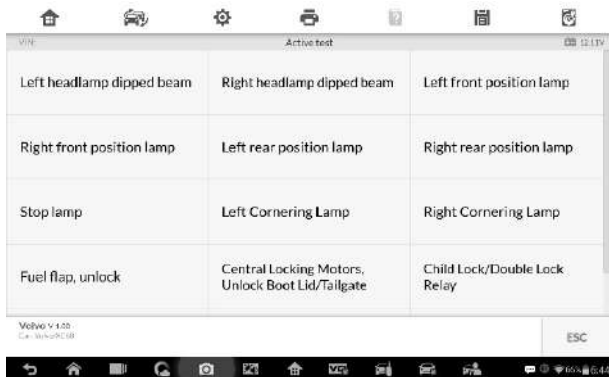

Figure 6-7 Sample Active Test Screen

The functional buttons at the lower right corner of the Active Test screen manipulate the test signals. The operational instructions are displayed on the main section of the test screen. Simply follow the on-screen instructions and make appropriate selections to complete the tests. Each time when an operation is successfully executed, message such as “Command Finished”, “Activation Successful”, or something similar displays.

Tap the **ESC** functional button to exit the test when finished.

Special Functions

These functions perform various component adaptations, allowing you to recalibrate or configure certain components after making repairs or replacement.

The main section of the Adaptation Operation screen displays a list of operational and vehicle status information, which mainly consists of four parts:

1. The first part in the top line shows the description of the operation being performed, and the execution status is displayed on the right, such as Completed, or Activated.
2. The second part shows the preconditions or requirements for executing the operation being selected.
3. The third part displays the current conditions of the vehicle control module being learned for comparison to the preconditions suggested by the second part. If the current condition of the control module is out of

the suggested limit value, you must adjust the vehicle condition to meet the requirement.

- The last part displays the instruction of how to use the functional button at the lower right corner of the screen to manipulate the teach-in operations.

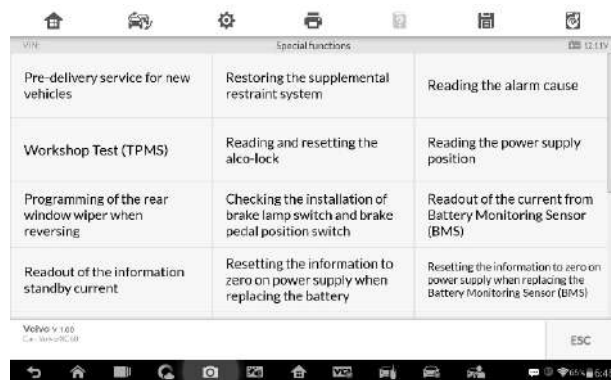

Figure 6-8 Sample Special Functions Screen

Read the information carefully and check the vehicle condition accordingly, when you are sure that the vehicle is ready to perform the adaptation, simply follow the instructions provided to make appropriate selections. When the operation is done, an execution status message such as Completed, Finished or Successful, displays.

Tap the **ESC** button to exit the function.

Generic OBD II Operations

A fast-access option for OBD II/EODB vehicle diagnosis is available on the Vehicle Menu screen. This option presents a quick way to check for DTCs, isolate the cause of an illuminated malfunction indicator lamp (MIL), check monitor status prior to emissions certification testing, verify repairs, and perform a number of other services that are emissions-related. The OBD direct access option is also used for testing OBD II/EODB compliant vehicles that are not included in the Diagnostics database.

Functions of the diagnostics toolbar buttons at the top of the screen are the same as those available for specific vehicle diagnostics. See [Table 4-2 Operation Toolbar Buttons](#) on page 38 for details.

General Procedure

➤ To access the OBD II/EODB diagnostics functions

1. Tap the **Diagnostics** application button from the MaxiIM Job Menu. The Vehicle Menu displays.
2. Tap the **EODB** button. There are two options to establish communication with the vehicle.
 - **Auto Scan** – when this option is selected the diagnostic tool attempts to establish communication using each protocol in order to determine which one the vehicle is broadcasting on.
 - **Protocol** – when this option is selected the screen opens a submenu of various protocols. A communication protocol is a standardized way of data communication between an ECM and a diagnostic tool. Global OBD may use several different communication protocols.
3. Select a specific protocol under the **Protocol** option. Wait for the OBD II Diagnostic Menu to appear.



NOTE

Tapping the ⓘ button displayed beside the function name opens a bubble with additional function information.

4. Select a function option to continue.
 - **DTC & FFD**
 - **I/M Readiness**
 - **Live Data**
 - **On-Board Monitor**
 - **Component Test**
 - **Vehicle Information**
 - **Vehicle Status**

NOTE

Some functions are supported only on certain vehicle makes.

Function Descriptions

This section describes the various functions of each diagnostic option:

DTC & FFD

When this function is selected, the screen displays a list of Stored Codes and Pending Codes. When the Freeze Frame data of certain DTCs are available for viewing, a snowflake button will display on the right side of the DTC item.



Figure 6-9 Sample DTC & FFD Screen

The erase codes function can be applied by tapping the **Clear DTC** button at the bottom of the screen.

- **Stored Codes**

Stored codes are the current emission related DTCs from the ECM of the vehicle. OBD II/EOBD Codes have a priority according to their emission severity, with higher priority codes overwriting lower priority codes. The priority of the code determines the illumination of the MIL and the codes erase procedure. Manufacturers rank codes differently, so expect to see differences between makes.

- **Pending Codes**

These are codes whose setting conditions were met during the last drive cycle, but need to be met on two or more consecutive drive cycles before the DTC actually sets. The intended use of this service is to assist the service technician after a vehicle repair and after clearing diagnostic information, by reporting test results after a driving cycle.

- a) If a test failed during the driving cycle, the DTC associated with that test is reported. If the pending fault does not occur again within 40 to 80 warm-up cycles, the fault is automatically cleared from memory.
- b) Test results reported by this service do not necessarily indicate a faulty component or system. If test results indicate another failure after additional driving, then a DTC is set to indicate a faulty component or system, and the MIL is illuminated.

- **Freeze Frame**

In most cases the stored frame is the last DTC that occurred. Certain DTCs, which have a greater impact on vehicle emission, have a higher priority. In these cases, the top prioritized DTC is the one for which the freeze frame records are retained. Freeze frame data includes a “snapshot” of critical parameter values at the time the DTC is set.

- **Clear DTC**

This option is used to clear all emission related diagnostic data such as, DTCs, freeze frame data and manufacturer specific enhanced data from the vehicle’s ECM.

A confirmation screen displays when the clear codes option is selected to prevent accidental loss of data. Select **Yes** on the confirmation screen to continue or **No** to exit.

I/M Readiness

This function is used to check the readiness of the monitoring system. It is an excellent function to use prior to having a vehicle inspected for compliance to a state emissions program. Selecting I/M Readiness opens a submenu with two choices:

- **Since DTCs Cleared** – displays the status of monitors since the last time the DTCs are erased.
- **This Driving Cycle** – displays the status of monitors since the beginning of the current drive cycle.

Live Data

This function displays the real time PID data from ECU. Displayed data includes analog inputs and outputs, digital inputs and outputs, and system status information broadcast on the vehicle data stream.

Live data can be displayed in various modes, see [Live Data](#) on page 66 for detailed information.

On-Board Monitor

This option allows you to view the results of On-Board Monitor tests. The tests are useful after servicing or after erasing a vehicle's control module memory.

Component Test

This service enables bi-directional control of the ECM so that the diagnostic tool is able to transmit control commands to operate the vehicle systems. This function is useful in determining whether the ECM responds to a command well.

Vehicle Information

The option displays the vehicle identification number (VIN), the calibration identification, and the calibration verification number (CVN), and other information of the test vehicle.

Vehicle Status

This item is used to check the current condition of the vehicle, including communication protocols of OBD II modules, retrieved codes amount, status of the Malfunction Indicator Light (MIL), and other additional information.

Exiting Diagnostics

The Diagnostics application remains open as long as there is an active communication with the vehicle. You must exit the diagnostics operation to stop all communications with the vehicle before closing the Diagnostics application.

 **NOTE**

Damage to the vehicle electronic control module (ECM) may occur if communication is disrupted. Make sure all connections, such as USB cable and wireless connection, are properly connected at all times during testing. Exit all tests before disconnecting the test connection or powering down the tool.

➤ **To exit the Diagnostics application**

1. From an active diagnostic screen, tap the **Back** or **ESC** functional button to exit a diagnostic session step-by-step.
2. Or tap the **Vehicle Swap** button on the diagnostics toolbar to return to the Vehicle Menu screen.
3. From the Vehicle Menu screen, tap the **Home** button on the top toolbar; or tap the **Back** button on the navigation bar at the bottom of the screen.
4. Or tap the **Home** button on the diagnostics toolbar to exit the application directly and go back to the MaxiIM Job Menu.

Now, the Diagnostics application is no longer communicating with the vehicle and it is safe to open other MaxiIM applications, or exit the MaxiIM Diagnostic System and return to the Android System's Home screen.

7 Service

The Service section is specially designed to provide you with quick access to the vehicle systems for various scheduled service and maintenance performances. The typical service operation screen is a series of menu driven executive commands. By following the on-screen instructions to select appropriate execution options, enter correct values or data, and perform necessary actions, the system will guide you through the complete performance for various service operations.

The most commonly performed service functions include:

- Oil Reset Service
- EPB Service
- BMS Service
- SAS Service
- DPF Service

After entering each special function, the displayed screen consists of two applications: **Diagnosis** and **Hot Functions**. The **Diagnosis** is for you to read/clear data since this is necessary after some special functions. **Hot Functions** consists of sub functions of the selected special function.

Oil Reset Service

This function allows you to perform reset for the Engine Oil Life system, which calculates an optimal oil life change interval depending on the vehicle driving conditions and climate. The Oil Life Reminder must be reset every time the oil is changed, so the system can calculate when the next oil change is required.

! IMPORTANT

Always reset the engine oil life to 100% after every oil change.

NOTE

1. All required work must be carried out before the service indicators are reset. Failure to do so may result in incorrect service values and cause DTCs to be stored by the relevant control module.
2. For some vehicles, the scan tool can perform added functionality to reset additional service lights (maintenance cycle, service interval). Taking BMW as an example, its service reset function includes engine oil, spark plugs, front/rear brakes, coolant, particle filter, brake fluid, micro filter, vehicle inspection, exhaust emission inspection and vehicle check.

All software screens shown in this manual are examples, actual test screens may vary for each vehicle being tested. Observe the menu titles and on-screen instructions to make correct option selections.

➤ To perform oil reset functions

1. Tap the **Service** application button from the MaxiIM Job Menu.
2. Tap **Oil Reset** button and wait for the vehicle manufacturer screen. You can tap **VIN Scan** or the vehicle make to acquire vehicle VIN information and tap **Yes** to confirm. See [Vehicle Identification](#) on page 34 for detail.
3. Tap the function you want in the Oil Reset function list, the list may vary for different vehicles being tested.

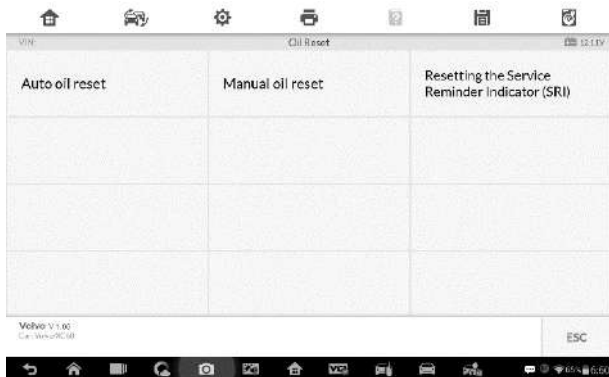

Figure 7-1 Sample Oil Reset Function List

- Follow the step-by-step on-screen instruction to complete the service. Take Auto oil reset as an example.
- Tap **Auto oil reset** on the Oil Reset function list to start the operation. The screen will notify you to turn the ignition switch to position 2, the engine must be off.



Figure 7-2 Sample Oil Reset Service Screen 1

- The screen will display Reset SRL data Routine completed once the operation is successfully done. Tap **OK** to exit. The operation procedure varies by function, please follow the onscreen instructions to complete.



Figure 7-3 Sample Oil Reset Service Screen 2

Electronic Parking Brake (EPB) Service

This function has a multitude of usages to maintain the electronic braking system safely and effectively. The applications include deactivating and activating the brake control system, assisting with brake fluid control, opening and closing brake pads, and setting brakes after disc or pad replacement, etc.

EPB Safety

It may be dangerous to perform Electronic Parking Brake (EPB) system maintenance, so before you begin the service work, please keep these rules in mind.

- ✓ Ensure that you are fully familiar with the braking system and its operation before commencing any work.
- ✓ The EPB control system may be required to be deactivated before carrying out any maintenance/diagnostic work on the brake system. This can be done from the tool menu.
- ✓ Only carry out maintenance work when the vehicle is stationary and on level ground.
- ✓ Ensure that the EPB control system is reactivated after the maintenance work has been completed.

NOTE

Autel accepts no responsibility for any accident or injury arising from the maintenance of the Electronic Parking Brake system.

➤ To perform EPB functions

1. Tap the **Service** application button from the MaxiIM Job Menu.
2. Tap **EPB** button and wait for the vehicle manufacturer screen. You can tap **VIN Scan** or the vehicle make to acquire vehicle VIN information and tap **Yes** to confirm. See [Vehicle Identification](#) on page 34 for detail.
3. Tap the service you want in the EPB function list, the list may vary for different vehicles being tested.

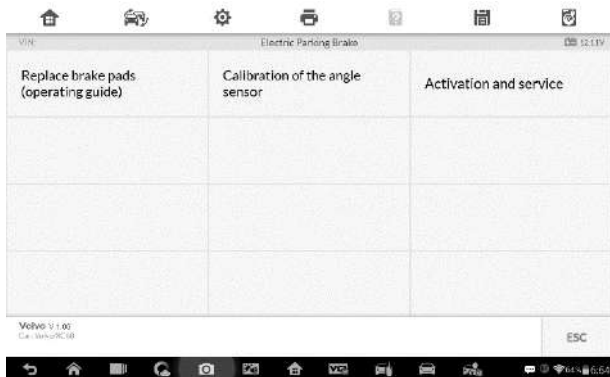

Figure 7-4 Sample EPB Function List

4. Follow the step-by-step on-screen instruction to complete the service.
5. Press **OK** button to exit.

Calibration of the angle sensor

This service function would calibrate the angle sensor, it must be conducted after the following repairs:

- Replacing an EMF control unit.
 - Replacing the parking brake button.
- 1) Tap **Start** to proceed this service function or the **Exit** button at the bottom left to exit.

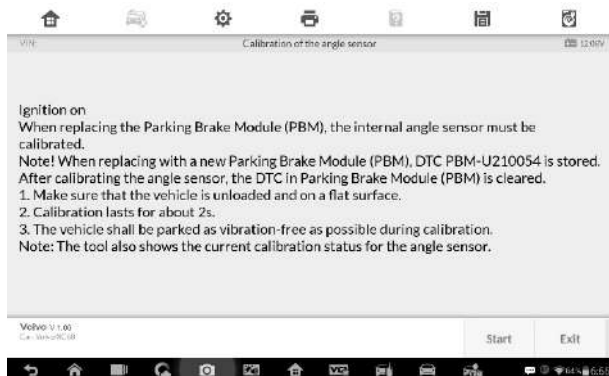

Figure 7-5 Sample Calibration of the Angle Sensor Screen 1

- 2) Ensure the vehicle is unloaded and is on a flat surface. The vehicle shall be parked as vibration-free as possible during calibration. Wait for about 20s. Press **Start** to start the calibration.

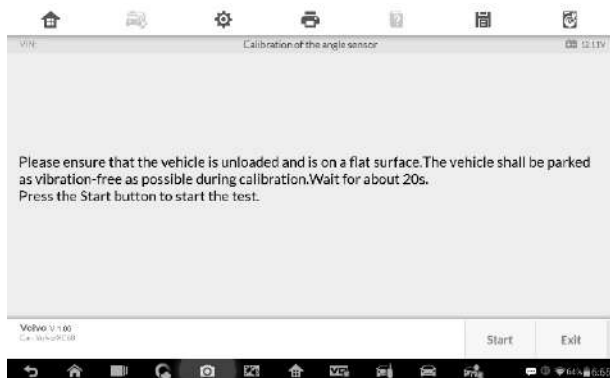

Figure 7-6 Sample Calibration of the Angle Sensor Screen 2

- 3) Once the calibration is complete, the screen will display the message "Calibration completed". Tap **OK** to exit.

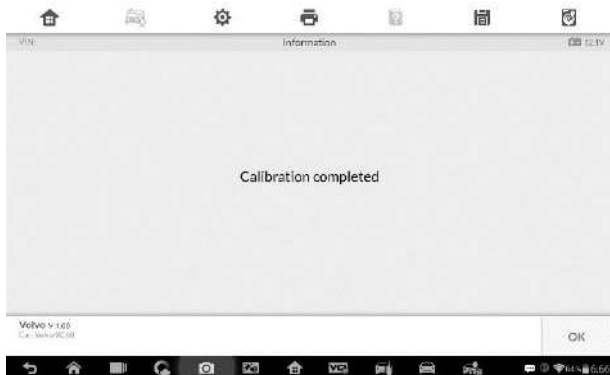

Figure 7-7 Sample Calibration of the Angle Sensor Screen 3

- 4) Read the DTCs to check the calibration of the angle sensor. If DTC PBM-U210054 has been generated, the calibration has failed. Tap **Start** to check the DTCs.



Figure 7-8 Sample Calibration of the Angle Sensor Screen 4

- 5) Once the calibration is successful. The screen displays the message “Calibration success”. Tap **Exit** to end the operation.

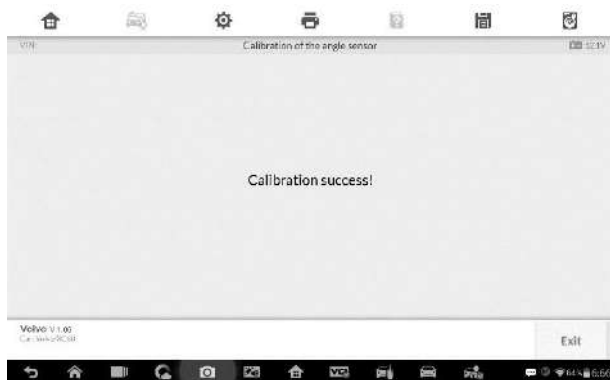

Figure 7-5 Sample Calibration of the Angle Sensor Screen 5

BMS

The BMS (Battery Management System) allows the scan tool to evaluate the battery charge state, monitor the close-circuit current, register the battery replacement, and activate the rest state of the vehicle.

NOTE

1. This function is not supported by all vehicles. The screens shown in this section are examples.
 2. The sub functions and actual test screens of the BMS may vary for different test vehicles, please follow the on-screen instructions to make correct option selection.
-

The vehicle may use either a sealed lead-acid battery or an AGM (Absorbed Glass Mat) battery. Lead acid battery contains liquid sulphuric acid and can spill when overturned. AGM battery (known as VRLA battery, valve regulated lead acid) also contains sulphuric acid, but the acid is contained in glass mats between terminal plates.

It is recommended that the replacement aftermarket battery has the same specifications, such as capacity and type, with the battery used in the vehicle.

If the original battery is replaced with a different type of battery (e.g. a lead-acid battery is replaced with an AGM battery) or a battery with a different capacity (mAh), the vehicle may require reprogramming the new battery type in addition to performing the battery reset. Consult the vehicle manual for additional vehicle-specific information.

Reset the information to zero

This option allows displaying the mileage reading of last battery replacement, registering the battery replacement after replacing a new battery and informing the power management system that a new battery has been fitted to the vehicle.

If the battery change is not registered, the power management system will not function properly, which may not provide the battery with enough charging power to operate the car and limit the functions of individual electrical equipment.

Take **BMW** as an example.

➤ To display the battery history

1. Tap the **Service** application button from the MaxiIM Job Menu.
2. Tap **BMS** button and wait for the vehicle manufacturer screen. You can tap **VIN Scan** or the vehicle make to acquire vehicle VIN information and tap **Yes** to confirm. See [Vehicle Identification](#) on page 34 for detail.
3. Tap **Resetting the information to zero on power supply when replacing the battery** in the EPB function list, the list may vary for different vehicles being tested.

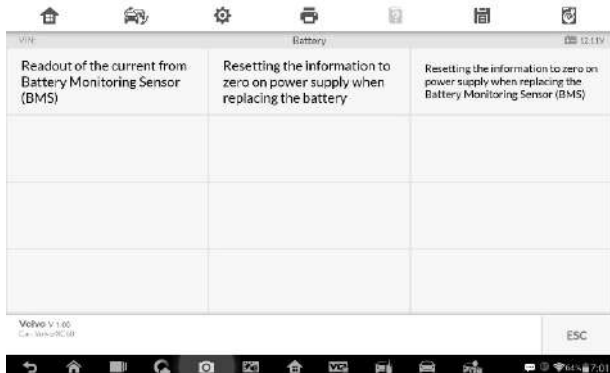

Figure 7-10 Sample BMS Function List

- The stored power supply information is reset using this service. Resetting to zero should only be performed when replacing the (main) battery. Once you confirm all the information displayed, tap **Continue** to proceed.

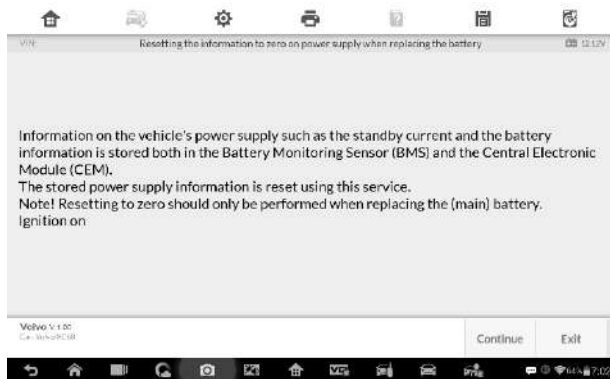

Figure 7-6 Sample BMS Function Screen 1

- Tap **Start** to reset the information to zero.

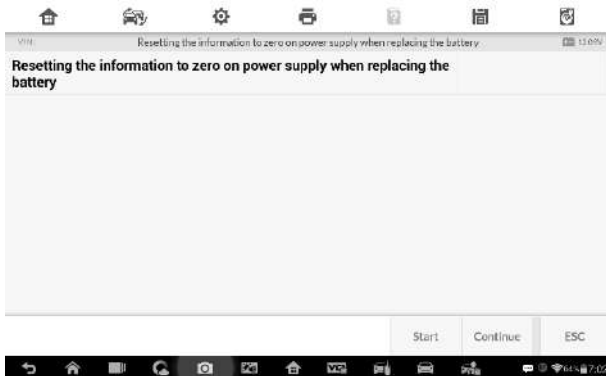

Figure 7-8 Sample BMS Function Screen 2

6. Once the reset is completed, the screen displays. Tap **Continue**.

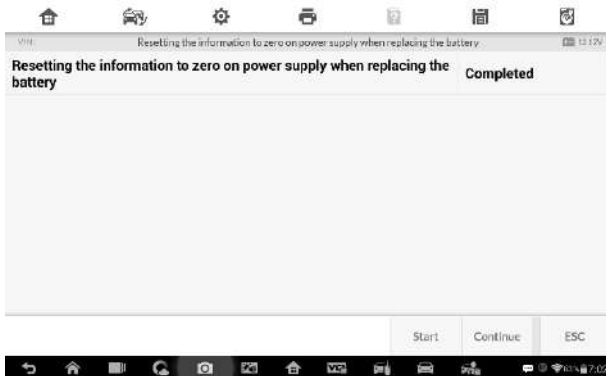

Figure 7-7 Sample BMS Function Screen 3

7. For the Battery Monitoring Sensor (BMS) to calculate the correct battery charging level, the vehicle must be in Sleep mode for a minimum of 4h after reset. In some cases, 6h in Sleep mode may be necessary. Read the onscreen instructions carefully and follow the instructions to ensure vehicle proper functioning.

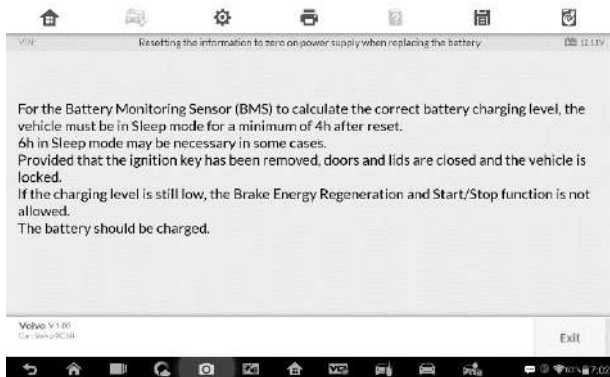

Figure 7-9 Sample BMS Function Screen 4

Steering Angle Sensor (SAS) Service

Steering Angle Sensor Calibration permanently stores the current steering wheel position as the straight-ahead position in the steering angle sensor EEPROM. Therefore, the front wheels and the steering wheel must be set exactly to the straight-ahead position before calibration. In addition, the vehicle identification number is also read from the instrument cluster and stored permanently in the steering angle sensor EEPROM. On successful completion of calibration, the steering angle sensor fault memory is automatically cleared.

Calibration must always be carried out after the following operations:

- Steering wheel replacement
- Steering angle sensor replacement
- Any maintenance that involves opening the connector hub from the steering angle sensor to the column
- Any maintenance or repair work on the steering linkage, steering gear or other related mechanism
- Wheel alignment or wheel track adjustment
- Accident repairs where damage to the steering angle sensor or assembly, or any part of the steering system may have occurred

NOTE

1. Autel accepts no responsibility for any accident or injury arising from servicing the SAS system. When interpreting DTCs retrieved from the vehicle, always follow the manufacturer's recommendation for repair.
2. All software screens shown in this manual are examples, actual test screens may vary for each vehicle being tested. Observe the menu titles and on-screen instructions to make correct option selections.
3. Before starting the procedure, make sure the vehicle has ESC. Look for the button on dash.

Take **Land Rover** as an example.

1. Tap the **Service** application button from the MaxiIM Job Menu.
2. Tap **SAS** button and wait for the vehicle manufacturer screen. You can tap **VIN Scan** or the vehicle make to acquire vehicle VIN information and tap **Yes** to confirm. See [Vehicle Identification](#) on page 34 for detail.
3. Tap the service you want in the SAS function list, the list may vary for different vehicles being tested.

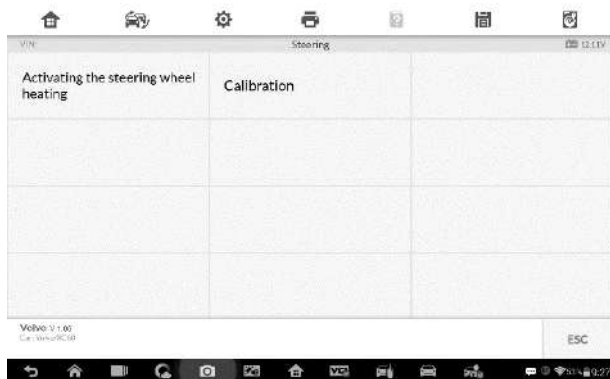

Figure 7-10 Sample SAS Function Menu

Activating the Steering Wheel Heating

This function can be used to activate the Steering Wheel Heating function directly from the Central Electronic Module (CEM). Upon activation, the Central Electronic Module (CEM) tries to activate the function despite of the

activation conditions. This indicates that the function should also be activated at high temperatures, poor battery voltage, engine off and active DTCs that normally have prevented the function from activation for the customer. Upon forced activation, the steering wheel heating can be turned off only by pressing the Cancel button, or by stopping the test.

- 1) Tap **Activating the Steering Wheel heating** from the SAS function menu to enter the function screen. The screen displays some notifications, read the notifications carefully and tap **Continue**.

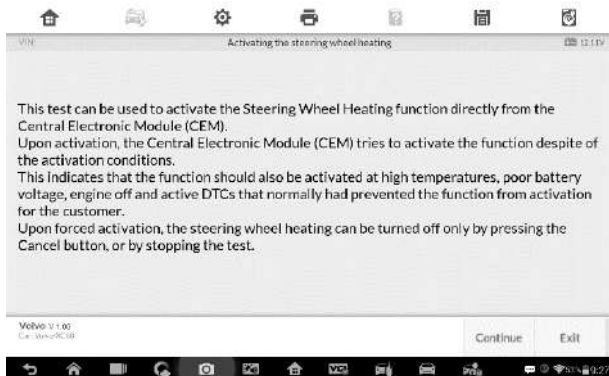

Figure 7-11 Sample SAS Function Screen 1

- 2) Tap **Forced activation** to start the test.

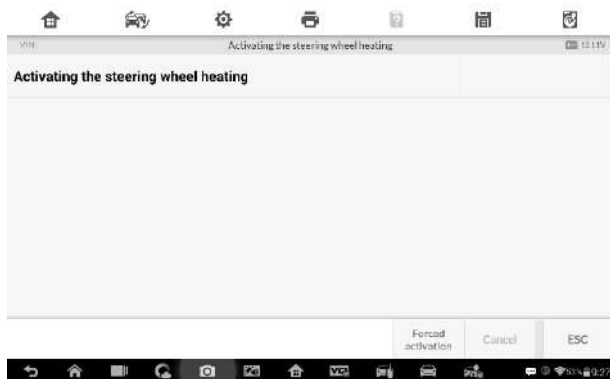

Figure 7-12 Sample SAS Function Screen 2

- 3) Once the activation is completed, the screen displays as follow. Tap **Forced activation** to start the test again or tap **ESC** to exit.

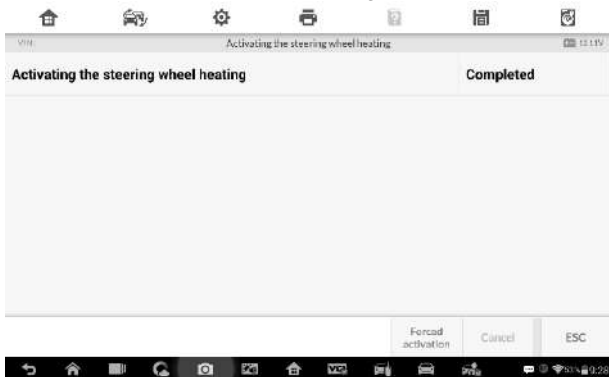

Figure 7-13 Sample SAS Function Screen 3

DPF Service

The DPF function allows you to carry out numerous functions to the Diesel Particulate Filter system without having to send your car to a main dealer. The tool will manage DPF regeneration, DPF component replacement teach-in and DPF teach-in after replacing the engine control unit.

ECM monitors driving style and selects a suitable time to employ regeneration. Cars driven a lot at idling speed and low load will attempt to regenerate earlier than cars driven more with high load and high speed. In order for regeneration to take place, a prolonged high exhaust temperature must be obtained.

In the event of the car being driven in such a way that regeneration is not possible, i.e. frequent short journeys, a diagnostic trouble code will eventually be registered, DPF light and “Check Engine” indicator comes on. A service regeneration can be requested in the workshop, using the diagnostic tool.

Before carrying out a forced DPF regeneration using the tool, check the following items:

- The fuel light is not on.
- No DPF-relevant faults stored in system.
- The vehicle has the correct spec engine oil.
- The oil for diesel is not contaminated.

IMPORTANT

Before diagnosing a problem vehicle and attempting to perform an emergency regeneration, it is important to obtain a full diagnostic log and read out relevant measured value blocks.

NOTE

1. The DPF will not regenerate if the engine management light is on, or there is a faulty EGR valve.
2. The ECU must be re-adapted when replacing the DPF and when topping up the fuel additive Eolys.

3. If the vehicle needs to be driven in order to perform a DPF service, ALWAYS have a second person help you. One person should drive the vehicle while the other person observes the screen on the Tool. Trying to drive and observe the Scan Tool at the same time is dangerous, and could cause a serious traffic accident.

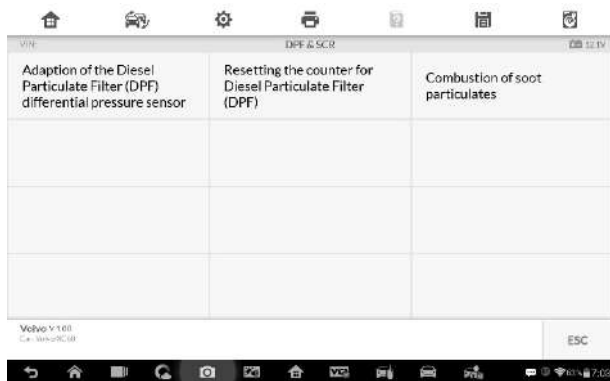

Figure 7-14 Sample DPF Service Function Menu

Resetting the Counter for DPF

This function is used to perform the adaption in the ECM and it is required following the replacement of DPF.

1. Tap **Resetting the Counter for DPF** from the service functions menu to enter the service screen. Tap **Continue** to proceed.

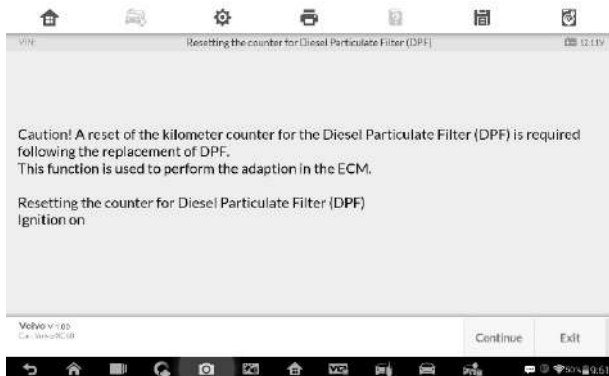

Figure 7-20 Sample DPF Function Screen 1

2. Tap **Start** to reset the counter.



Figure 7-21 Sample DPF Function Screen 2

3. Wait for 3 seconds, once the reset is complete, the screen displays “The function is implemented”. Tap **Start** to reset again or tap **ESC** to exit.

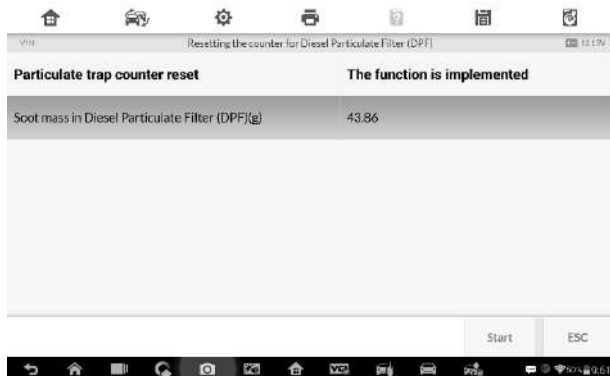

Figure 7-22 Sample DPF Function Screen 3

8 Update

The Update application allows you to download the latest released software. The updates can improve the MaxiIM applications' capabilities, typically by adding new tests, new models, or enhanced applications to the database.

The Display Tablet automatically searches for available updates for all of the MaxiIM software when it is connected to the internet. Any updates that are found can be downloaded and installed on the device. This section describes installing an update to the MaxiIM System. A notification message displays if an update is available when the Notifications Center function is enabled in the Settings application.



Figure 8-1 Sample Update Screen

1. Navigation and Controls

- Home Button – returns to the MaxiIM Job Menu.
- Update All – updates all available updates.
- IMMO Tab – displays all available IMMO software for vehicles.
- Diagnostics Tab – displays all available vehicle diagnostic softwares.
- Search Bar – search specific update item by inputting the file name, for example: a vehicle make.

2. Status Bar

- Left Side – displays the MaxiIM device model information and serial number.
- Right Side – displays an update progress bar indicating the completion status.

3. Main Section

- Left Column – displays vehicle logos and update software version information; tap the **About** button displays a function list in PDF showing more details about the software.
- Middle Column – displays a brief introduction about the new changes to the software operation or capabilities. Tap **i** button to open an information screen to view more details, and tap the dim area around to close the window.
- Right Column – according to the operation status of each software item, the button displays differently.
 - a) Tap **Update** to update the selected item.
 - b) Tap **Pause** to suspend the updating procedure.
 - c) Tap **Continue** to go on updating the suspended update.

➤ To update the diagnostic software and TPMS service software

1. Make sure the Display Tablet is connected to a power source with stable access to the internet.
2. Tap the **Update** application button from the MaxiIM Job Menu; or tap the update notification message when received one; or tap the **Update** icon on Vehicle Menu in Diagnostics application. The Update application screen displays.
3. Check all available updates:
 - If you decide to update all the items of IMMO software, select **IMMO** Tab and then tap the **Update All** button; if you want to update all items of diagnostic software, select **Diagnose** Tab and then tap the **Update All** button.
 - If you only want to update one or some of the item(s), tap the **Update** button on the right column of the specific item(s).
4. Tap the **Pause** button to suspend the updating process. When you tap **Continue** to renew the update, the updating process will

resume from the break point.

5. When the updating process is completed, the firmware will be installed automatically. The previous version will be replaced.

9 Settings

Selecting Settings application opens a setup screen, on which you can adjust default setting and view information about the MaxilM system. There are seven options available for the MaxilM system settings:

- **Unit**
- **Language**
- **Printing Setting**
- **Notification Center**
- **Auto Update**
- **About**
- **System Settings**

This section describes the operation procedures for the settings.

Unit

This option allows you to adjust the measurement unit for the diagnostic system.

➤ **To adjust the unit setting**

1. Tap the **Settings** application on the MaxilM Job Menu.
2. Tap the **Unit** option on the left column.
3. Select the required measurement unit, Metric or English. A tick icon will display to the right of the selected unit.

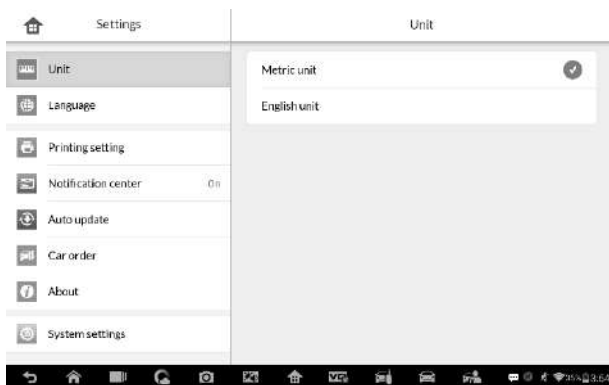

Figure 9-1 Sample Unit Screen

4. Tap the **Home** button on the top left corner to return to the MaxiIM Job Menu. Or select another setting option for system setup.

Language

This option allows you to adjust the display language for the MaxiIM system.

➤ **To adjust the language setting**

1. Tap the **Settings** application on the MaxiIM Job Menu.
2. Tap the **Language** option on the left column.



Figure 9-2 Sample Language Screen

3. Select the required language. A tick icon will display to the right of the selected language.
4. Tap the **Home** button on the top left corner to return to the MaxiIM Job Menu. Or select another setting option for system setup.

Printing Setting

This option allows you to print any data or information anywhere and anytime via Wi-Fi connection.

➤ **To setup the printer connection**

1. Tap the **Settings** application on the MaxiIM Job Menu.
2. Tap the **Printing Setting** option on the left column.
3. Tap the **Print via Network** item to activate the printing function, which enables the device to send files to the printer through the PC via Wi-Fi connection.

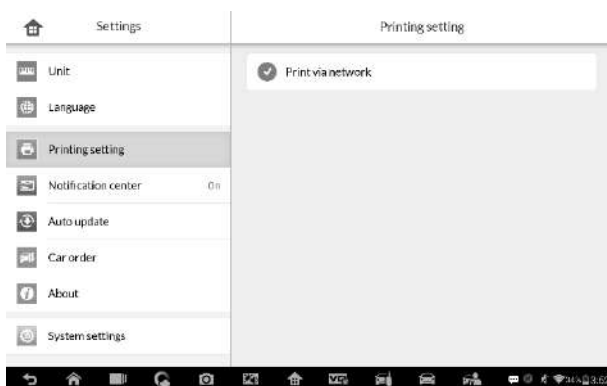

Figure 9-3 Sample Printing Setting Screen

4. Tap the **Home** button on the top left corner to return to the MaxiIM Job Menu. Or select another setting option for system setup.

 **NOTE**

The **Autel Printer** runs automatically after the installation. Before printing make sure the Display Tablet is connected to the same network with the computer, either via Wi-Fi or LAN. And the computer is connected to a printer.

➤ **To perform printing via PC**

1. Run the **Autel Printer** on the computer.
2. Click **Test Print** to make sure the printer is working successfully.
3. Tap the **Print** button on the toolbar of the Display Tablet. A temporary document will be created and sent to the computer.
 - ✧ If the **Auto Print** option in the Autel Printer is selected, the Autel Printer will print the received document automatically.
 - ✧ If the **Auto Print** option is not selected, click **Open PDF File** button to view all the temporary files. Select the file(s) you want to print and click **Print**.

➤ **To perform printing via APP**

If a Wi-Fi printer is available, please purchase a Wi-Fi printer APP and install it onto your Display Tablet. By a simple click on the **Print** button of a saved file on the Display Tablet, the file will be printed automatically.

Notification Center

This option allows you to turn the Notification Center function on or off. The Notification Center function configures the MaxiIM tablet to receive regular on-line messages from the server for system update notifications or other service information via the Internet. It is highly recommended to keep this function on all the time, so you won't miss out any new update for MaxiIM or event from Autel. Internet access is required for receiving on-line messages.

➤ **To enable the Notification Center function**

1. Tap the **Settings** application on the MaxiIM Job Menu.
2. Tap the **Notification Center** option on the left column.

3. Tap the **ON/OFF** button to enable or disable the Notifications function. If the function is enabled the button turns blue, or if disabled the button turns gray.

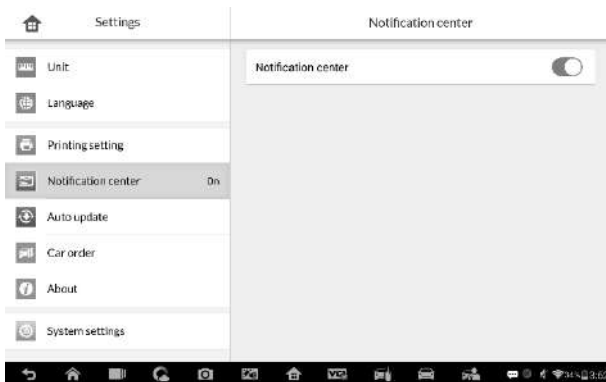

Figure 9-4 Sample Notification Center Screen

4. Tap the **Home** button on the top left corner to return to the MaxiIM Job Menu. Or select another setting option for the system setup.

When the Notification Center function is turned on, and new messages are received by the MaxiIM device, a notification message displays on the MaxiIM Job Menu. Press on the message bar and drag it down, and the received messages are shown in the list, slide the list up or down to view all if the message list covers more than one screen.

Tapping a specific message launches the corresponding application. For example, if you tap on an Update notification message, the Update application will be launched.

Auto Update

The Auto Update allows the tool to automatically update the OS, the MaxiIM system, and the vehicle software. All you need to do is to switch ON by tapping the button on the right side of each and set the desired automatic update time.

- **To set auto system or vehicle update**

1. Tap the **Settings** application on the MaxiIM Job Menu.
2. Tap the **Auto Update** option on the left column. The three auto update items list on the right.
3. Switch the ON the button on the right of item that you want to auto update.

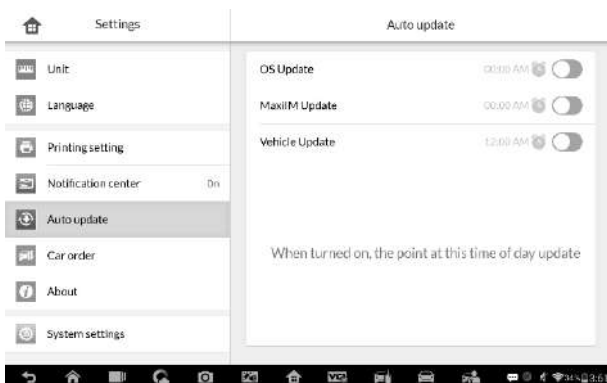

Figure 9-5 Sample Auto Update Screen

4. Tap on the time to set time, you can use the **+** and **-** button or tap on the numbers then the manual input screen will pop up. Tap **Done** to complete the time setting.

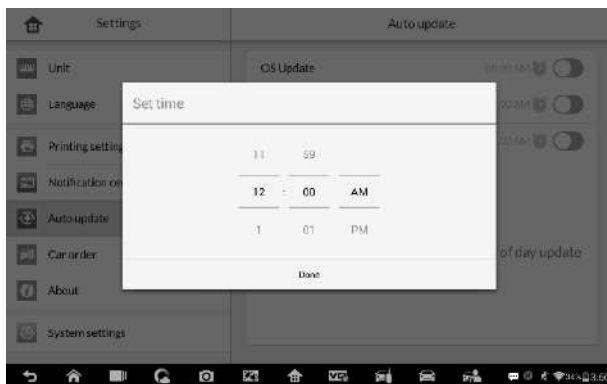

Figure 9-6 Sample Set Time Screen

NOTE

Internet connection is necessary for auto update, otherwise it would not work even if you have already switch it on. Make sure the tool is connected to the Internet for the time you have set.

About

The About option provides information of the MaxiIM diagnostic device regarding the product name, version, hardware, and serial number, etc.

➤ **To check the MaxiIM product information in About**

1. Tap the **Settings** application on the MaxiIM Job Menu.
2. Tap the **About** option on the left column. The product information screen displays on the right.



Figure 9-7 Sample About Screen

3. Tap the **Home** button on the top left corner to return to the MaxiIM Job Menu, or select another setting option for the system setup after viewing.

System Settings

This option provides you a direct access to the Android background system setting screen, on which you can adjust various system settings for the Android system platform, regarding wireless and networks settings, various

device settings such as sound and display, as well as system security settings, and check the associated information about the Android system, etc.

You may refer to Android documentation for additional information about Android system settings.

10 Remote Desk

The Remote Desk application launches the TeamViewer Quick Support program, which is a simple, fast and secure remote control screen. You can use the application to receive ad-hoc remote support from Autel's support center, colleagues, or friends, by allowing them to control your MaxilM tablet on their PC via the TeamViewer software.

If you think of a TeamViewer connection as a phone call, the TeamViewer ID would be the phone number under which all TeamViewer Clients can be reached separately. Computers and mobile devices that run TeamViewer are identified by a globally unique ID. The first time the Remote Desk application is started, this ID is generated automatically based on the hardware characteristics and will not change later on.

Make sure the Display Tablet is connected to the Internet before launching the Remote Desk application, so that the Display Tablet is accessible to receive remote support from the third party.

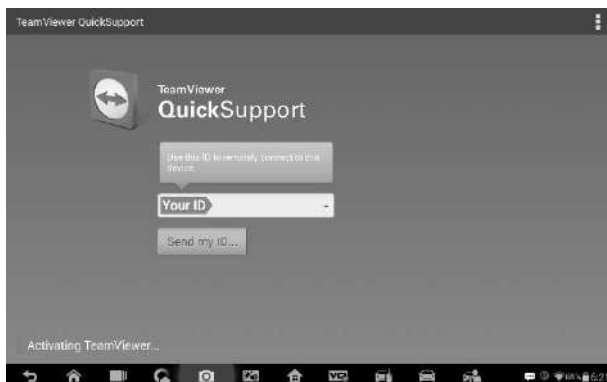

Figure 10-1 Sample Remote Desk Screen

➤ **To receive remote support from a partner**

1. Power on the Display Tablet.

2. Tap the **Remote Desk** application on the MaxiIM Job Menu. The TeamViewer screen displays and the device ID is generated and shown.
3. Your partner must install the Remote Control software to his/her computer by downloading the TeamViewer full version program online (<http://www.teamviewer.com>), and then start the software on his/her computer at the same time, in order to provide support and take control of the Display Tablet remotely.
4. Provide your ID to the partner, and wait for him/her to send you a remote control request.
5. A popup displays to ask for your confirmation to allow remote control on your device.
6. Tap **Allow** to accept, or tap **Deny** to reject.

Refer to the associated TeamViewer documents for additional information.

11 Data Manager

The Data Manager application is used to store, print, and review the saved files. Most operations are controlled through the toolbar.

Selecting the Data Manager application opens the file system menu. Different file types are sorted separately under different options, there are five types of information files to be viewed or played back.

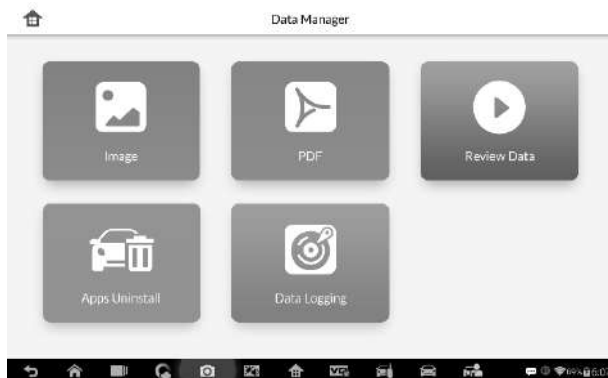

Figure 11-1 Sample Data Manager Main Screen

Operations

Data Manager Operations are based on toolbar controls. Details are explained in the following sections.

Image Files

The Image section contains all captured screenshot images.

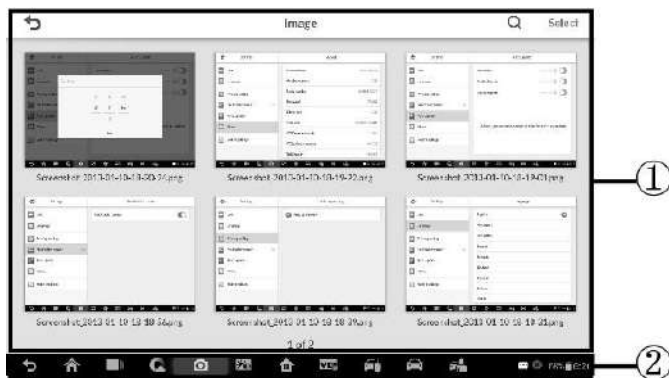







Figure 11-2 Sample Image Screen

1. **Toolbar Buttons** – used to edit, print and delete the image files. See the following table for detailed information.
2. **Main Section** – displays the stored images.

Table 11-1 Toolbar Buttons in Image

Button	Name	Description
	Back	Returns to the previous screen.
	Enter Edit	Tapping this button shows the editing toolbar to print, delete or view image information.
Cancel	Cancel	Tapping this button close the editing toolbar or cancels file search.
	Search	Quickly locates the image file by entering the vehicle name, test path, file name or file info.
	Info	Tapping this button opens a window displaying the details of the image.
	Print	Tapping this button prints the selected image.

	Delete	Tapping this button deletes the selected image.
--	---------------	---

➤ **To edit image information**

1. Select **Data Manager** application from the MaxiIM Job Menu.
2. Select **Image** to access the image database.
3. Select an image to display it in full screen.
4. Tap the screen to display the editing toolbar.
5. Tap the **Info** button to open a window displaying the image information.
6. Tap the **Edit** button on the top right corner of the window. The editing screen displays.
7. Edit the image information by entering the new file name, and file information.
8. Tap **Done** to save the information and exit, or tap **Cancel** to exit without saving.

 **NOTE**

To realize the wireless data printing function, you need to install the printer driver program.

➤ **To install the printer driver program**

1. Please download the **Autel PC Suite** from www.autel.com > Support & Updates > Firmware & Downloads > UPDATE CLIENT, and install to your PC. The Autel PC Suite consists of Autel Printer, and Autel PC Suite.
2. Double click on **Setup.exe** item.
3. Select the installation language and the printer driver installation wizard will load momentarily.
4. Follow the wizard instructions on the screen and click **Next** to continue.

5. Click on **Install** and the printer driver program will be installed onto the computer.
6. Click on **Finish** to complete the whole installation procedure.

➤ **To delete selected images**

1. Select **Data Manager** application from the MaxilM Job Menu.
2. Select **Image** to access the JPG database.
3. Tap the **Enter Edit** button to display the editing toolbar.
4. Select the images that need to be deleted by tapping the thumbnail images, the selected thumbnail displays a tick icon at the bottom right corner.
5. Tap the **Delete** button, and then **Delete Selected**, then the selected images will be deleted.

PDF Files

The PDF section stores and displays all PDF files of saved data. After entering the PDF database, select a PDF file to view the stored information.

This section uses the standard Adobe Reader application for file viewing and editing, please refer to the associated Adobe Reader manual for more detailed instructions.

Review Data

The Review Data section allows you to playback the recorded data frames of live data streams.

On the Review Data main screen, select a record file to playback.

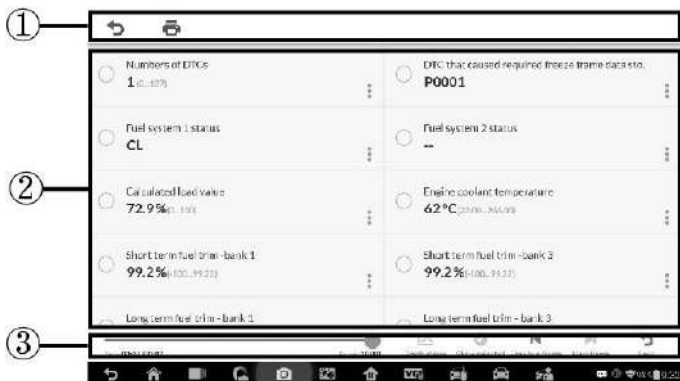

Figure 11-3 Sample Data Playback Screen

1. **Drop-down Toolbar** – tap the button at the top center of the screen to open the Drop-down Toolbar.
2. **Main Section** – displays the recorded data frames.
3. **Navigation Toolbar** – allows you to manipulate data playback.

Use the Navigation Toolbar buttons to playback the record data from frame to frame. Tap **Back** to exit data playback.

Apps Uninstall

This section allows you to manage the firmware applications installed on the MaxiIM Diagnostics System. Selecting this section opens a managing screen, on which you can check all the available vehicle diagnostic applications.

Select the vehicle firmware you want to delete by tapping on the car brand icon, the selected item will display a blue tick at the upper right corner. Tap the **Delete** button on the top bar to delete the firmware from the system database.

Data Logging

The Data Logging section allows you to launch Support platform directly to view all records of all sent or unsent (saved) data loggings on the diagnostic system.







12 Shop Manager



The Shop Manager application helps you to manage the workshop information, customer information records, and keep test vehicle history records, which can be a great assist in dealing with daily workshop business and improves customer service. There are three main functions available:

- **Vehicle History**
- **Workshop Information**
- **Customer Manager**

The operations of these functions are mainly manipulated by the toolbar buttons, which are listed and described in the table below:

Table 12-1 Top Toolbar Buttons in Shop Manager

Button	Name	Description
	Back	Returns to the previous screen.
	Enter Edit	Shows the editing toolbar to print or delete the selected file.
	Delete	Touching it deletes the selected vehicle record item from the list.
	Search	Quickly locates the vehicle record by entering the vehicle name or test path.
Cancel	Cancel	Touching it to cancel edit or file search.
	Edit	Touching it allows you to edit information for the displayed file.
	Add Account	Touching this button to create a new customer account file.

Button	Name	Description
	History Notes	Touching this button opens a note form, which allows you to create audio record, attach picture or video, or edit text notes, etc.
	Vehicle History	Touching this button opens the Vehicle History screen which displays the correlated test vehicle records.
Done	Done	Complete editing and save the file.

Vehicle History

This function stores records of test vehicle history, including vehicle information and the retrieved DTCs from previous diagnostic sessions, and displays all information in an easy-to-check table list, on which you can view summarized details and manually input other information about the test vehicle and diagnostic loggings, etc. The Vehicle History also provides direct access to the previously tested vehicle and allows you to restart a diagnostic session without the need to do vehicle identification again.

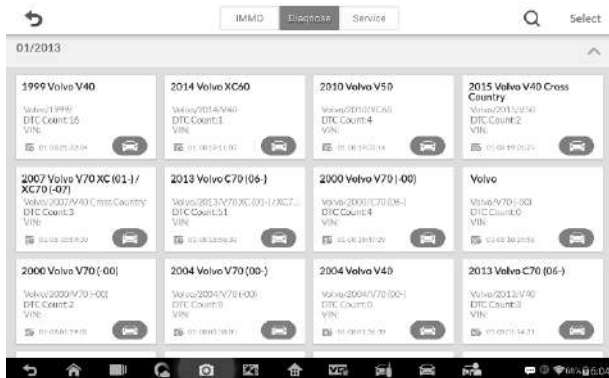

Figure 12-1 Sample Vehicle History Screen

- Top Toolbar Buttons** – navigates and makes various controls of the application. IMMO, Diagnose and Service records are sorted under respective tabs.

2. **Main Section** – displays all the vehicle history records information.
- **To activate a test session for the recorded vehicle**
1. Tap the **Shop Manager** application on the MaxiIM Job Menu.
 2. Select **Vehicle History**
 3. Tap the **Diagnostics** button at the bottom of the thumbnail of a vehicle record item. Or,
 4. Select a vehicle record item by tapping the thumbnail.
 5. A Historical Test record sheet displays, check the recorded information of the recorded test vehicle, and tap the Diagnostics button on the upper right corner.
 6. The vehicle's Diagnostics screen displays, now a new diagnostic session is activated, see [Diagnosis](#) on page 60 for detailed instructions on vehicle diagnostic operations.

Historical Test Record

The Historical Test record sheet of the tested vehicle is a detailed data form, which includes all general information of the vehicle such as vehicle year, make and model, etc., and the diagnostic trouble codes retrieved from the previous test sessions, as well as other service details which can be added manually by the technician himself.

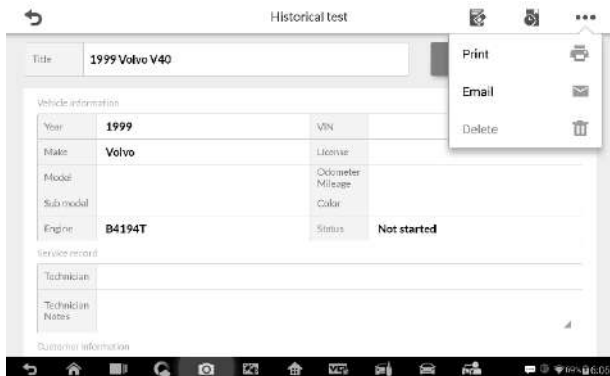

Figure 12-2 Sample Historical Test Record Sheet

➤ **To edit the Historical Test record sheet**

1. Tap the **Shop Manager** application on the MaxIM Job Menu.
2. Select **Vehicle History**.
3. Select the specific vehicle history record thumbnail from the main section. The Historical Test record sheet displays.
4. Tap the **Edit** button to start editing.
5. Tap on each item to input the corresponding information or add attaching files or images.

NOTE

The vehicle VIN number, or license and the customer information account are correlated by default. Adding one of the information will automatically associate the other item in the record sheet, provided that the later one exists.

6. Tap **Add to Customer** to correlate the Historical Test record sheet to an existing customer account, or add a new associating account to be correlated with the test vehicle record. See [Customer Manager](#) on page 121 for more information.
7. Tap **Done** to save the updated record sheet, or tap **Cancel** to exit without saving.

Workshop Information

The Workshop Information form allows you to edit, input and save the detailed workshop information, such as shop name, address, phone number and other remarks, which, when printing vehicle diagnostic reports and other associated test file, will appear as the header of the printed documents.

Shop name	Required	Tel	Required
Address			
City		Manager name	
State		Manager title	
Zipcode		Email	
Fax		Website	
Slogan			
Remark			

This information will appear on the header of printed reports.

Figure 12-3 Sample Workshop Information Sheet

- **To edit the Workshop Information sheet**
 1. Tap the **Shop Manager** application on the MaxiIM Job Menu.
 2. Select **Workshop Information**.
 3. Tap the **Edit** button on the top toolbar.
 4. Tap on each field to input the appropriate information.
 5. Tap **Done** to save the updated workshop information sheet, or tap **Cancel** to exit without saving.

Customer Manager

The Customer Manager function allows you to create and edit customer accounts. It helps you to save and organize all customer information accounts that are correlated with the associated test vehicle history records, which is a great support for the arrangement of daily workshop business.

➤ **To create a customer account**

1. Tap the **Shop Manager** application on the MaxiIM Job Menu.
2. Select **Customer Manager**.
3. Tap the **Add Account** button. An empty information form displays, tap each field to input the appropriate information.

 **NOTE**

The items that must be filled are indicated as required fields.

4. Tap the cross mark beside the Name chart to add a photo. A sub menu displays, select **Take Photo** to take a new photo for the account, or select **Choose Photo** to choose from the existing files.
5. Some customers may have more than one vehicle for service; you can always add new vehicle information to the account to be correlated. Tap **Add New Vehicle Information**, and then fill in the vehicle information. Tap the  button to cancel adding.
6. Tap **Done** to save the account, or tap **Cancel** to exit without saving.

➤ **To edit a customer account**

1. Tap the **Shop Manager** application on the MaxiIM Job Menu.
2. Select **Customer Manager**.
3. Select a customer account by tapping the corresponding name card. A Customer Information sheet displays.
4. Tap the **Edit** button on the top toolbar to start editing.
5. Tap on the input field where needs to be altered or supplemented, and enter updated information.
6. Tap **Done** to save the updated information, or tap **Cancel** to exit without saving.

➤ **To delete a customer account**

1. Tap the **Shop Manager** application on the MaxiIM Job Menu.

2. Select **Customer Manager**.
3. Select a customer account by tapping the corresponding name card. A Customer Information sheet displays.
4. Tap the **Edit** button on the top toolbar to start editing.
5. Tap the **Delete Customer Information** button. A confirmation message displays.
6. Tap **OK** to confirm the command, and the account is deleted. Tap **Cancel** to cancel the request.

History Notes

The History Notes function allows you to add audio and video records, text notes and photos, to keep multi-media work logs for the associated customer account, which can be very helpful when dealing with repeat customers. Keeping notes for each vehicle serviced for each customer will keep you always on track and well organized in business.

➤ To access History Notes

1. Tap the **Shop Manager** application on the MaxiIM Job Menu.
2. Select **Customer Manager** or **Vehicle History**.
3. Select a customer account by tapping the corresponding name card. A Customer Information sheet displays (if **Customer Manager** is selected). Or, select a vehicle history record item to open the Historical Test record sheet (if **Vehicle History** is selected).
4. Tap the **History Notes** button on the top bar. Now the History Notes screen displays.

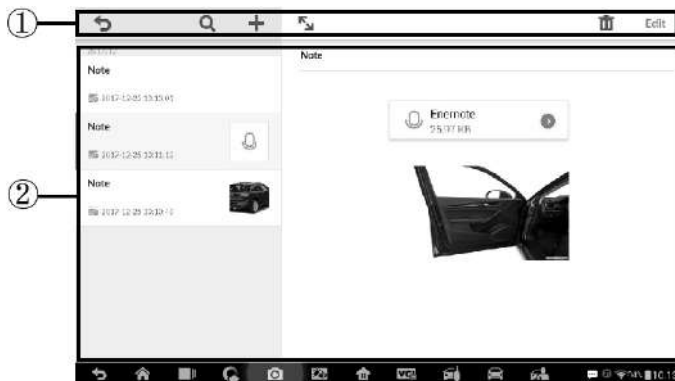

Figure 12-4 Sample History Notes Screen

1. **Functional Buttons** – navigates and make various controls of the function.
2. **Main Section** – displays the note list on the left column and the detail information of the selected note on the right column.

➤ **To add a note in History Notes**

1. Access History Notes.
2. Tap the **Add Notes** button. An edit window displays.
3. Tap on the Title bar to input a note title.
4. Tap on the blank space below to edit a text note or remark.
5. Select a function button on the top to add files in any form you choose.
6. Tap **Save** to save the note; tap **Discard** or **Cancel** to exit without saving.

13 VCI Manager

This application pairs the tablet with the MaxiFlash, checks the communication status and update the VCI software.

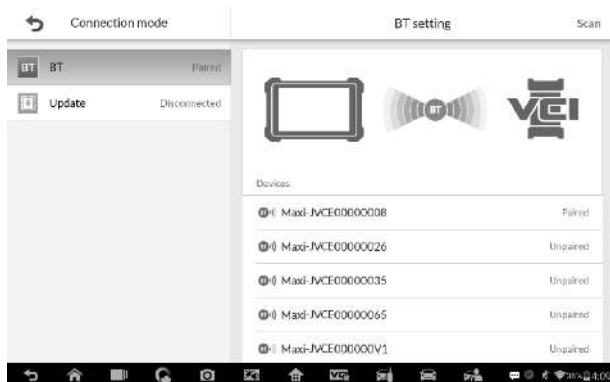

Figure 13-1 Sample VCI Manager Screen

1. Connection Mode – there are three connection modes available for selection. The connection state is displayed alongside.
 - BT Pairing – when paired to a wireless device, the connection state displays as Paired; otherwise it displays as Unpaired.
 - Update (for VCI software only) – when the MaxiIM tablet and the MaxiFlash are connected by a USB cable, this function is used to update VCI software via Internet.
2. BT Setting

The BT Setting screen displays the types and product serial numbers for all the devices available for pairing. Tap a required device to start pairing. The BT status icon displayed to the left of the device name indicates the received signal strength.

BT Pairing

The MaxiFlash needs to be connected to a vehicle, so that it is powered during the synchronization procedure. Ensure the tablet has sufficient battery life or is connected to an external power supply.

➤ **To pair the MaxiFlash with the Tablet**

1. Power on the tablet.
2. Insert the 16-pin vehicle data connector of the MaxiFlash to the vehicle data link connector (DLC).
3. Tap the **VCI Manager** application on the MaxiFlash Job Menu of the tablet.
4. Select **BT** from the connection mode list.
5. Tap the **Scan** button at the top right corner. Now the device starts searching for available pairing units.
6. The device name may display as MaxiFlash suffixed with a serial number. Select the appropriate device for pairing.
7. When pairing is successfully done, the connection status displayed to the right of the device name is shown as **Paired**.
8. Once paired, the VCI button on the system Navigation bar at the Connection LED on the MaxiFlash illuminates solid blue. This signifies that the tablet is connected to the MaxiFlash, and is ready to perform vehicle diagnosis.
9. Tap the paired device again to unpair it.
10. Tap the **Home** button on the top left to return to the MaxiIM Job Menu.

🔗 **NOTE**

A MaxiFlash can be paired to only one tablet at a time, and once it's paired, the device will not be discoverable to other devices.

Update

When connected to the Internet, this function checks for available update. When there is a new software version available, tap the displayed **Update**

button to update. Otherwise, the tablet will display “Your software is up to date”.

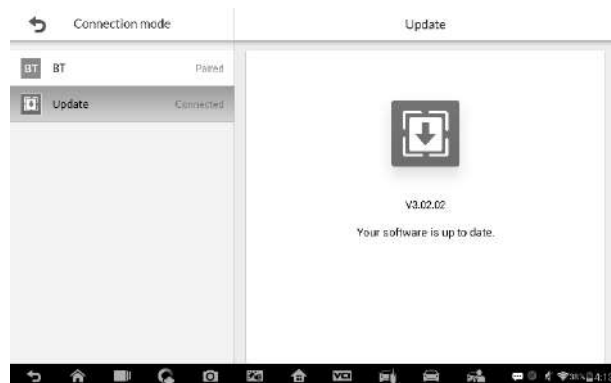

Figure 13-2 Sample Update Screen

14 Maintenance and Service

Maintenance Instructions

The following shows how to maintain your devices, together with precautions to take.

- Use a soft cloth and alcohol or a mild window cleaner to clean the touch screen of the tablet.
- Do not use any abrasive cleansers, detergent, or automotive chemicals to the tablet.
- Maintain the devices in dry conditions and keep them within normal operating temperatures.
- Dry your hands before using the tablet. The touch screen of the tablet may not work if the touch screen is moist, or if you tap the touch screen with wet hands.
- Do not store the devices in humid, dusty or dirty areas.
- Check the housing, wiring, and connectors for dirt and damage before and after each use.
- At the end of each work day, wipe the device housing, wiring, and connectors clean with a damp cloth.
- Do not attempt to disassemble your tablet or the VCI unit.
- Do not drop or cause severe impact to the devices.
- Use only authorized battery chargers and accessories. Any malfunction or damage caused by the use of unauthorized battery charger and accessories will void the limited product warranty.
- Ensure that the battery charger does not come in contact with conductive objects.
- Do not use the tablet beside microwave ovens, cordless phones and some medical or scientific instruments to prevent signal interference.

Troubleshooting Checklist

A. When the Display Tablet does not work properly:

- Make sure the tablet has been registered online.
- Make sure the system software and diagnostic application software are properly updated.
- Make sure the tablet is connected to the Internet.
- Check all cables, connections, and indicators to see if the signal is being received.

B. When battery life is shorter than usual:

- This may happen when you are in an area with low signal strength. Turn off your device if it is not in use.

C. When you cannot turn on the tablet:

- Make sure the tablet is connected to a power source or the battery is charged.

D. When you are unable to charge the tablet:

- Your charger maybe out of order. Contact your nearest dealer.
- You may be attempting to use the device in an overly hot/cold temperature. Try changing the charging environment.
- Your device may have not been connected to the charger properly. Check the connector.

NOTE

If your problems persist, please contact Autel's technical support personnel or your local selling agent.

About Battery Usage

Your tablet is powered by a built-in Lithium-ion Polymer battery. This means that, unlike other forms of battery technology, you can recharge your battery while some charge remains without reducing your tablet's autonomy due to the "battery memory effect" inherent in those technologies.

 **DANGER**

The built-in Lithium-ion Polymer battery is factory replaceable only; incorrect replacement or tampering with the battery pack may cause an explosion. Do not use a damaged battery charger.

- Do not disassemble or open crush, bend or deform, puncture or shred.
- Do not modify or remanufacture, attempt to insert foreign objects into the battery, expose to fire, explosion or other hazard.
- Make sure to use the charger and USB cables only that come together in the package. If you use the other charger and USB cables, you might incur malfunction or failure of the device.
- Only use the charging device that has been qualified with device per the standard. Use of an unqualified battery or charger may present a risk of fire, explosion, leakage, or other hazard.
- Avoid dropping the tablet. If the tablet is dropped, especially on a hard surface, and the user suspects damage, take it to a service center for inspection.
- The closer you are to your network's base station, the longer your tablet usage time because less battery power is consumed for the connection.
- The battery recharging time varies depending on the remaining battery capacity.
- Battery life inevitably shortens over time.
- Since over charging may shorten battery life, remove the tablet from its charger once it is fully charged. Unplug the charger, once charging is complete.
- Leaving the tablet in hot or cold places, especially inside a car in summer or winter, may reduce the capacity and life of the battery. Always keep the battery within normal temperatures.

15 Compliance Information

FCC Compliance

This device complies with Part 15 of the FCC rules and Industry Canada's license-exempt RSSs. Operation is subject to the following two conditions:

1. This device may not cause harmful interference.
2. This device must accept any interference received, including interference that may cause undesired operation.

Cet appareil est conforme aux CNR exempts de licence d'Industrie Canada. Son fonctionnement est soumis aux deux conditions suivantes:

1. Ce dispositif ne peut causer des interférences; et
2. Ce dispositif doit accepter toute interférence, y compris les interférences qui peuvent causer un mauvais fonctionnement de l'appareil.

WARNING

Changes or modifications not expressly approved by the party responsible for compliance could void the user's authority to operate the equipment.

NOTE

This equipment has been tested and found to comply with the limits for a Class B digital device, pursuant to Part 15 of the FCC Rules. These limits are designed to provide reasonable protection against harmful interference in a residential installation.

This equipment generates uses and can radiate radio frequency energy and, if not installed and used in accordance with the instructions, may cause harmful interference to radio communications. However, there is no guarantee that interference will not occur in a particular installation. If this equipment does cause harmful interference to radio or television reception, which can be determined by turning the equipment off and on, the user is encouraged to try to correct the interference by one or more of the following measures:

- Reorient or relocate the receiving antenna.
- Increase the separation between the equipment and receiver.
- Connect the equipment into an outlet on a circuit different from that to which the receiver is connected.
- Consult the dealer or an experienced radio/TV technician for help.

Changes or modifications not expressly approved by the party responsible for compliance could void the user's authority to operate the equipment.

SAR

The radiated output power of this device is below the FCC radio frequency exposure limits. Nevertheless, the device should be used in such a manner that the potential for human contact is minimized during normal operation.

The exposure standard for wireless devices employs a unit of measurement known as the Specific Absorption Rate, or SAR. The SAR limit set by the FCC is 1.6 W/Kg. Tests for SAR are conducted using standard operating positions accepted by the FCC with the device transmitting at its highest certified power level in all tested frequency bands.

Although the SAR is determined at the highest certified power level, the actual SAR level of the device while operating can be well below the maximum value. This is because the device is designed to operate at multiple power levels so as to use only the power required to reach the network. To avoid the possibility of exceeding the FCC radio frequency exposure limits, human proximity to antenna should be minimized.

RF WARNING STATEMENT

The device has been evaluated to meet general RF exposure requirement. The device can be used in portable exposure condition without restriction.

The term "IC" before the radio certification number only signifies that IC technical specifications were met.

RoHS COMPLIANCE

This device is declared to be in compliance with the European RoHS Directive 2011/65/EU.

CE COMPLIANCE

This product is declared to conform to the essential requirements of the following Directives and carries the CE mark accordingly:

EMC Directive 2014/30/EU

R&TTE Directive 2014/53/EU

Low Voltage Directive 2014/35/EU

16 Warranty

Limited One Year Warranty

Autel Intelligent Technology Corp., Ltd. (the Company) warrants to the original retail purchaser of this MaxiIM Diagnostic Device, that should this product or any part thereof during normal consumer usage and conditions, be proven defective in material or workmanship that results in product failure within one (1) year period from the date of purchase, such defect(s) will be repaired, or replaced (with new or rebuilt parts) with Proof of Purchase, at the Company's option, without charge for parts or labor directly related to the defect(s).

The Company shall not be liable for any incidental or consequential damages arising from the use, misuse, or mounting of the device. Some states do not allow limitation on how long an implied warranty lasts, so the above limitations may not apply to you.

This warranty does not apply to:

- a) Products subjected to abnormal use or conditions, accident, mishandling, neglect, unauthorized alteration, misuse, improper installation or repair or improper storage;
- b) Products whose mechanical serial number or electronic serial number has been removed, altered or defaced;
- c) Damage from exposure to excessive temperatures or extreme environmental conditions;
- d) Damage resulting from connection to, or use of any accessory or other product not approved or authorized by the Company;
- e) Defects in appearance, cosmetic, decorative or structural items such as framing and non-operative parts.
- f) Products damaged from external causes such as fire, dirt, sand, battery leakage, blown fuse, theft or improper usage of any electrical source.

! **IMPORTANT**

All contents of the product may be deleted during the process of repair. You should create a back-up copy of any contents of your product before any repair services.
