User's Manual

Applicable to D800

Revised on 11 April 2023

Contents

Chapter 1: Introduction.....	1
1. Product Profile.....	1
2. Features.....	1
2.1. Diagnostic Function	1
2.2. IMMO	1
2.3. ECU Flasher.....	1
2.4. Personal Center	1
2.5. Data Management.....	1
2.6. Support.....	2
2.7. Settings.....	2
2.8. Upgrade	2
3. Product Information	2
3.1. The whole set	2
3.2. The tablet computer	2
4. Technical Parameters	3
5. Accessories (Standard Configuration).....	3
5.1. Main Test Cable	3
5.2. Other Connectors	3
5.3. Others Accessories.....	3
6. Charge This Device.....	4
7. Using Battery	4
8. Power On/Power Off This Device	5
9. About Desktop.....	5
10. Customize Your Desktop.....	5
10.1. Add Items to the Desktop	5
10.2. Move Items on the Desktop.....	6
10.3. Delete Items from the Desktop.....	6
10.4. Change Your Wallpaper	6
10.5. Create a Folder on the Desktop	6
11. On Using Touch Screen	6
12. Auto-Rotate the Screen	6
13. Lock & Unlock.....	7
13.1. Lock the Screen.....	7
13.2. Unlock the screen	7
14. Notification Bar	7
14.1. Draw Down the Notification Panel.....	7

14.2. Draw Up the Notification Panel	7
15. Input Method	7
15.1. Set Input Method.....	7
16. How to Set as Airplane Mode	8
Chapter 2: Upgrade	9
1. Detect System Upgrade	9
2. Diagnostic Function Upgrade.....	10
Chapter 3: Diag Notes	13
1. Connect VCI Connector.....	13
2. Diagnosis Flowchart.....	13
3. Personal Center	13
3.1. User Registration	14
3.2. User Login	15
3.3. Edit User Information	16
3.4. Change Password.....	17
3.5. View Distributor Information.....	17
3.6. Recover Password.....	18
3.7. Recharge CREDIT.....	19
3.8. Authorization Center	19
3.9. Order History	20
4. Diagnostic Software Main Interface Introduction.....	21
5. Start Diagnosing	22
5.1. Supported Brands	22
5.2. Diagnosis.....	24
5.2.1 DTC	27
5.2.2 Read Data Stream	28
5.2.3 Active Test	30
5.2.4 Special Functions	30
5.3. Interactive Circuit Diagrams.....	33
6. Data Management.....	34
6.1. My Data	34
6.2. Data Playback	35
6.3. Uninstall Model	35
6.4. Diagnose Report	36
6.5. Picture Viewer	36
6.6. File Management.....	37
7. Support.....	37
7.1. Video	38

7.2. Manual.....	38
7.3. FAQ.....	39
7.4. Log Upload.....	39
7.5. TeamViewer.....	40
7.6. Abnormal Feedback.....	41
8. Settings.....	42
8.1. VCI Info.....	42
8.2. Language.....	42
8.3. Unit.....	43
8.4. Workshop.....	43
8.5. Network Test.....	43
8.6. Clear Cache.....	44
8.7. System Settings.....	45
8.8. About.....	45
Chapter 4: Others.....	47
1. Email.....	47
1.1. Add An Email Account.....	47
1.2. Delete An Email Account.....	47
1.3. Send An Email.....	47
1.4. View email.....	48
2. Wi-Fi.....	48
2.1. Turn on WLAN.....	48
2.2. Connect to WLAN.....	48
3. Browser.....	49
3.1. Open the Browser.....	49
3.2. Browser Webpage.....	49
3.3. Zoom In/Zoom Out the Page.....	49
3.4. Save Favorite Webpages to Bookmarks.....	50
3.5. Open Multiple Pages.....	50
3.6. Customize Internet Settings.....	50
4. Calculator.....	50
5. Calendar.....	50
6. Camera.....	51
6.1. Turn On/Off the Camera.....	51
6.2. Take a Photo.....	51
6.3. View a Photo.....	51
6.4. Record a Video.....	51
6.5. View a Video.....	52

6.6. Customize Camera Settings	52
6.7. Customize Video Camera Settings	52
7. Gallery	52
7.1. Open the Gallery.....	53
7.2. View a Photo.....	53
8. Clock.....	53
8.1. Add an Alarm	53
8.2. Delete an Alarm	53
8.3. Customize Your Alarm	53
8.4. Timer Setting	54
8.5. Stopwatch Setting.....	54
9. Music.....	54
10. ES File Explorer	54
11. Display	55
11.1. Brightness	55
11.2. Auto-Rotate the Screen	55
12. Set Screen Lock.....	55
13. Application	55
13.1. View Installed Applications	55
13.2. View the Running Applications	56
14. Language & Input	56
14.1. Language Setting:	56
14.2. Input Method Setting:	56
15. Set Date & Time.....	56
16. Restore to Factory Settings.....	57
17. Storage	57
18. App Installation/Uninstallation.....	57
Chapter 5: FAQ.....	58
1. Startup Failure	58
2. Touchscreen Interference.....	58
3. Slow or Failed Upgrade.....	58
4. Crash.....	58
5. Test Failure	58
6. Unable to Charge.....	59
7. Upgrade Software.....	59
8. Delete Software.....	59
9. Switch the System Language	59
Chapter 6: Remarks.....	60

1. Copyright Information	60
2. Trademark Information	60
3. Safety Precautions	61
4. Precautions on Using This Device	62
5. Precautions for ECU Operation	62
6. Safety Warnings and Precautions	62
7. Medical Equipment	62
8. Flammable and Explosive Area	63
9. Traffic Safety	63
10. Operating Environment	63
11. Child Health	64
12. Environmental Protection	64
13. Original Accessories	64
14. Usage of the Battery and the Charger	64
15. Repair and Maintenance	65
16. Warranty	66
17. Order Notification	66
18. Customer Service Center	66
19. Disclaimer	67

Chapter 1: Introduction

1. Product Profile

D800 is OBDSTAR's new generation device for marine (jet ski/ outboard/ inboard/ generator) intelligent diagnosis.

Based on Samsung Exynos processor, it is equipped with an 8-inch display screen, which is extremely fast and smooth.

D800 adopts the latest 3.0 APK platform and has shortcut functions such as auto-identification, intelligent retrieval, and one-click feedback. The equipment, with its fast upgrade performance and built-in help materials, is a good helper for marine maintenance engineers!

2. Features

2.1. Diagnostic Function

Diagnose the electronic control system of prevailing vehicle models covering Asia, Europe, Americas. Diagnosis functions include: ECU information, code reading, code clearing, data flow, freeze frames, action test, setting, coding etc.

The product is specially designed for Android platform, its interface is transparent, and the operation is easy.

2.2. IMMO

Enter IMMO, you can perform anti-theft programming.

2.3. ECU Flasher

This function can read ECU data and program ECU.

2.4. Personal Center

User information and the device's configuration information.

2.5. Data Management

It includes My Data, Data Playback, Uninstall Model, Diagnose Report, Picture Viewer and File Management.

2.6. Support

Equipped with powerful database. A large collection of how-to videos helps users to operate the device easily.

2.7. Settings

It can set VCI Info, Language, Unit, Workshop, Network Test, Clear cache, System Settings and About.

2.8. Upgrade

Built-in WIFI mode can realize application downloading and diagnostic function by one-click upgrade.

3. Product Information

3.1. The whole set

The package contains one tablet computer, one main test cable and some adapter cables.

3.2. The tablet computer



4. Technical Parameters

- Operation system: Android 5.1.1
- CPU: Exynos4418 Quad Core ARM Cortex A9 1.4GHz
- Battery: 3700mAh, rechargeable polymer lithium battery
- Expansion memory card: 32G Micro SD (TF) card supported
- LCD: 8.0 inch
- LCD resolution: 1280*800
- Touch screen: Capacitive touch screen
- Wi-Fi: Supported
- Working temperature: -10°C ~ 55°C (14°F ~ 131°F)
- Storage temperature: -20°C ~ 70°C (-4°F ~ 158°F)
- Weight: about 1.0kg
- Dimension: 254mm*174mm*35mm

5. Accessories (Standard Configuration)

5.1. Main Test Cable

The main cable varies with configuration.

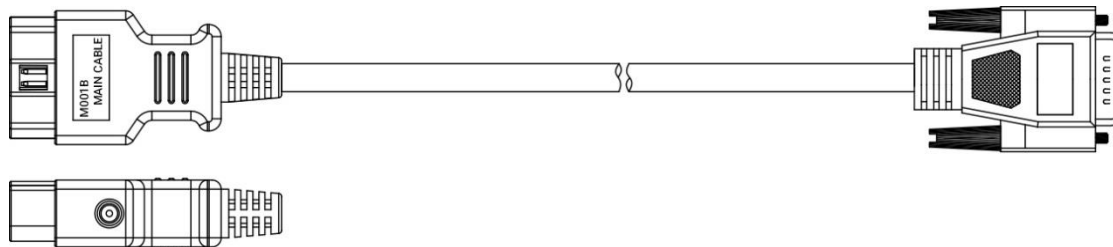

5.2. Other Connectors

Other connectors are used to connect the diagnosis socket of specific models. Choose the connector according to the marine brand and models.



Note: Accessories vary with configurations.

5.3. Others Accessories

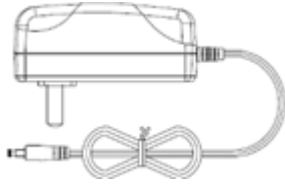
DC Power Adapter (Output DC 12V/2A) powers the tablet by connecting to an external power source.



6. Charge This Device

- a) Connect the in-package USB cable with charger.
- b) Plug the charger into AC outlet.
- c) When it connects to charger, battery logo indicates , it indicates that the battery is charging.
- d) When battery logo changes into , it indicates that the battery is fully charged.
- e) Unplug USB cable on the charger from this device. 

7. Using Battery

- If the battery keeps unused for a long time or battery is completely discharged, it is normal if it cannot be turned on while being charged. Please charge it for a period and then turn it on.
- Using data service will cause more power consumption and shorten the standby time.
- The charging time of battery varies with temperature condition and battery consumption status.
- While this device has low battery, a beep will sound. If the battery is running very low, this device will be switched off automatically.

Note: Do one of the followings to save power :

- When this device keeps unattended, press POWER key to turn off the LCD.
- Shorten the standby time: Enter the main menu, choose "Settings" > "DEVICE" > "Display" > "Sleep" to select a shorter standby time.

- Decrease the brightness of LCD display: Enter main menu, choose "Settings" > "DEVICE" > "Display" > "Brightness", and then drag the slider to adjust it.
- Change "Live wallpaper" into "Gallery".
- Set Bluetooth off: Enter the main menu, choose "Settings" > "Bluetooth", and then switch to OFF.
- Press VOLUME key to decrease the volume.

8. Power On/Power Off This Device







8.1. Power On

Press and hold Power button for 3 seconds to turn on this device.

8.2. Power Off

Press and hold Power button for 3 seconds to turn off this device.

9. About Desktop

ICON	FUNCTION	DESCRIPTION
	Back button	Go back to previous interface or exit program.
	Print screen	Make a quick screenshot and save it to gallery.
	Home button	Return to the desktop.
	Touch screen menu button	Press this key to quickly switch between open windows.
	DP button	Enter diagnose and program interface.
	VCI button	Enter system settings.

10. Customize Your Desktop

10.1. Add Items to the Desktop

On the main menu, tap and hold the desired item, the system will automatically enter the desktop and place the icon into the

circle. Tip: If many applications occupy the desktop, tap and hold the desired one to move it to an extended desktop.

10.2. Move Items on the Desktop

Tap and hold the item to be moved. After a movable circle appears on the screen, drag it to the target location.

10.3. Delete Items from the Desktop

Tap and hold the desired item, "Delete" will appear in the upper middle of the screen. Drag the item to "Delete", and release it when the item icon turns red.

10.4. Change Your Wallpaper

Tap and hold a blank area on the desktop, a pop-up wallpaper will be shown on the screen. Choose desired wallpaper. Click upper left corner "v" to set wallpaper.

10.5. Create a Folder on the Desktop

Drag one icon to another icon, the system will create a folder automatically. Then, input the folder name.

11. On Using Touch Screen

- Tap: Tap the corresponding item with your finger to confirm the selection or start the application.
- Long tap: Long tap an icon or an input field to open the operation option menu of the current interface.
- Slide: Slide your finger horizontally or vertically on the screen.
- Drag: Long tap the selected item with your finger, and then drag the item to any position on the screen.

12. Auto-Rotate the Screen

To perform such operation as browsing webpage, viewing images etc., rotate this device, the screen will automatically change the

display direction. To disable this function, enter “Settings” and click “Display”, then unselect the option “Auto-rotate the screen”.

13. Lock & Unlock

13.1. Lock the Screen

- When the device is ON, press POWER key to lock the screen.
- The system will lock the screen automatically if this device remains on standby for a long time.

13.2. Unlock the screen

- Press POWER key to activate the screen and then drag the lock to "Unlock position".

14. Notification Bar

The notification bar is used to display some activities or messages to remind and inform users.

14.1. Draw Down the Notification Panel

- When a new notification icon appears on the status bar, slide the status bar downwards to open it.
- In the notification panel, click the desired notification item to open it.

14.2. Draw Up the Notification Panel

- When the notification panel is unfolded, tap on the blank area of the screen, and then the notification panel will automatically retract.

15. Input Method

15.1. Set Input Method

- Enter the main menu and then select "Settings"-> "Personal" -> "Language & input" to choose the desired input method.

-
- The default input method supports a powerful word stock engine, multiple keyboard modes. Android keyboard and Google input methods make input easier.
 - To start the text input mode, please click any text input field.

16. How to Set as Airplane Mode

- According to the regulations of some countries or regions, PC device must be turned off before boarding on the airplane.
- One of the methods to disable the functions of this device is to set it as airplane mode. In this mode, all radio waves of this product are turned off, including mobile network, Bluetooth and WLAN.
- Do one of the followings to enable or disable airplane mode:
 - Press POWER key, then swipe down from the top of the screen and tap "Airplane mode" in the drop-down box.
 - Access the main menu, and choose "Settings" > "WLAN" > "More" > "Airplane mode".

Chapter 2: Upgrade

1. Detect System Upgrade

The system APK automatically detects the version. If there is a version update, a red dot will appear in the upper right corner of the upgrade icon. Click the upgrade icon, the prompt "Whether to upgrade software?" will pop up.

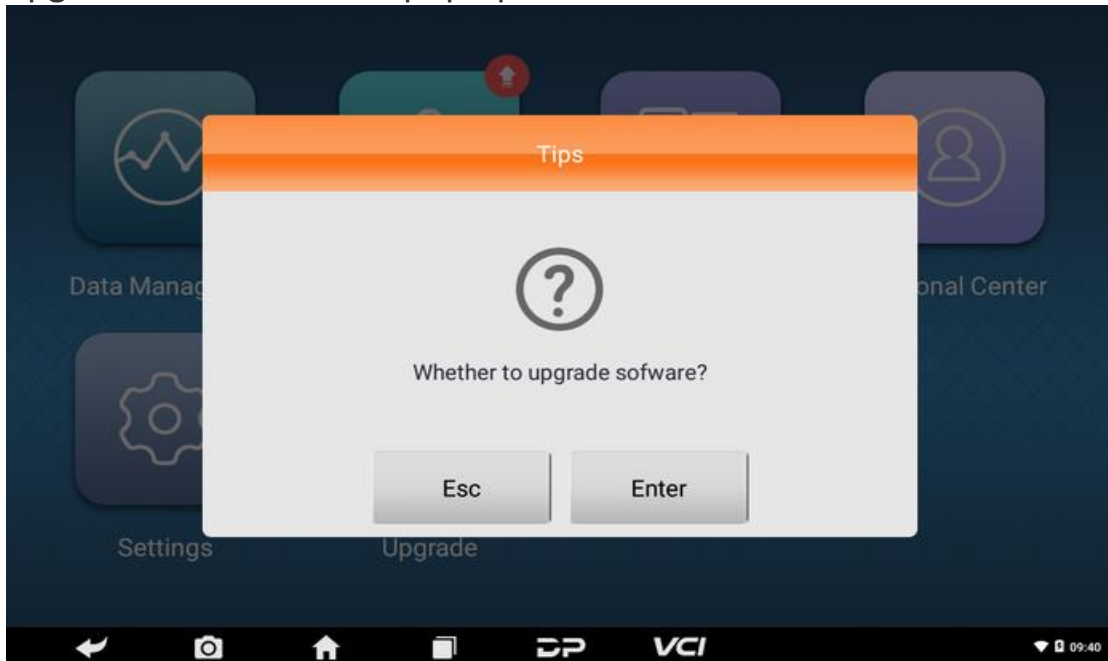

If you "Esc" the upgrade, it will directly return to the main interface; if you "Enter" APK upgrade, an installation message box will pop up.

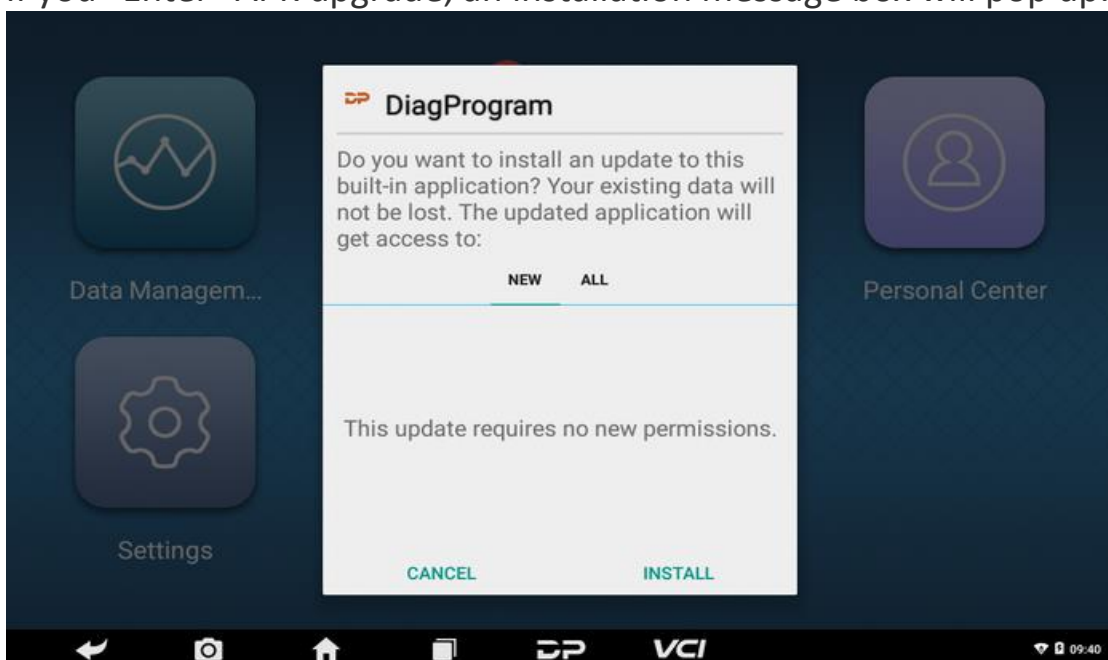

Click "INSTALL" to upgrade and install the APK. After the upgrade, a disclaimer will appear, then click on "Agree" to enter the diagnostic function interface.

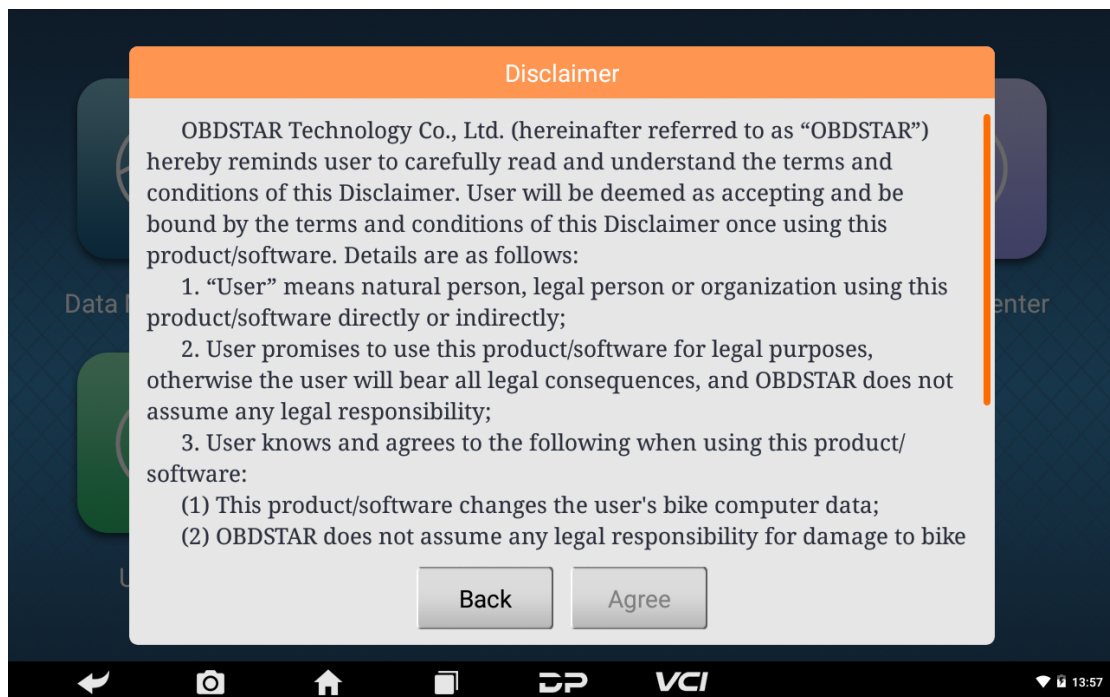

2. Diagnostic Function Upgrade

If more than one downloaded model diagnosis software needs to be upgraded, download and upgrade software by bulk upgrade. The software provided in the following is for reference only.

Upgrade					
<input checked="" type="checkbox"/>	Software name	Current version	Downloadable	Upgrade(25/25)	Upgrade Content
<input checked="" type="checkbox"/>	BASIC DATA-COMM	-	10.35	725.51 KB	
<input checked="" type="checkbox"/>	BasicData-Software	-	-	-	
<input checked="" type="checkbox"/>	BasicData-Info	-	-	-	
<input checked="" type="checkbox"/>	DIAG-MARINE-BRP	-	31.05	7.20 MB	
<input checked="" type="checkbox"/>	DIAG-MARINE-EVINRUDE	-	31.01	1.91 MB	
<input checked="" type="checkbox"/>	DIAG-MARINE-HONDA	-	31.10	7.70 MB	
<input checked="" type="checkbox"/>	DIAG-MARINE-JOHNSON	-	31.02	1.91 MB	
<input checked="" type="checkbox"/>	DIAG-MARINE-KAWASAKI	-	31.00	7.07 MB	
<input checked="" type="checkbox"/>	DIAG-MARINE-MERCURY	-	31.02	60.86 MB	

At the bottom of the table, there are two tabs: 'All' (selected) and 'Favorites'. To the right of the tabs is an upward-pointing arrow icon. The background shows a dark interface with some icons and the text 'Data' and 'enter'.

Click the icon below the Upgrade Content to view the details of the software upgrade.

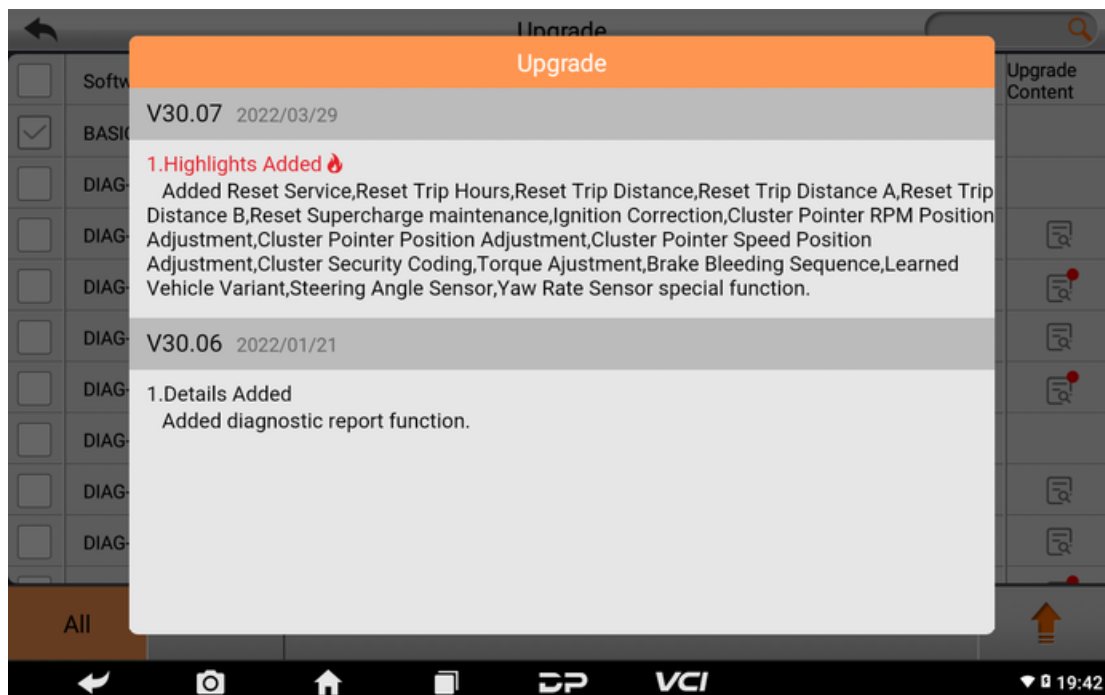

Click the check box in front of the software name, and then click upgrade icon at the bottom to start downloading and updating.

<input checked="" type="checkbox"/>	Software name	Current version	Downloadable	Upgrade(1/25)	Upgrade Content
<input checked="" type="checkbox"/>	BASIC DATA-COMM	-	10.35		
<input checked="" type="checkbox"/>	BasicData-Software	-	-	6.73 MB(0/7) 2.81 MB	
<input checked="" type="checkbox"/>	BasicData-Info	-	-	5.47 KB(1/10) 0.00 KB	
<input checked="" type="checkbox"/>	DIAG-MARINE-BRP	-	31.05	7.20 MB	
<input checked="" type="checkbox"/>	DIAG-MARINE-EVINRUDE	-	31.01	1.91 MB	
<input checked="" type="checkbox"/>	DIAG-MARINE-HONDA	-	31.10	7.70 MB	
<input checked="" type="checkbox"/>	DIAG-MARINE-JOHNSON	-	31.02	1.91 MB	
<input checked="" type="checkbox"/>	DIAG-MARINE-KAWASAKI	-	31.00	7.07 MB	
<input checked="" type="checkbox"/>	DIAG-MARINE-MERCURY	-	31.02	60.86 MB	

If a software needs to be canceled, just tap the corresponding check box. You can search for the model to be upgraded in the search box (Fuzzy Search function). As the following photo shown:



After the upgrade is completed, you can enter the diagnostic programming to view the upgrade version description and the version number, and you can perform relevant diagnostic operations.

Tips: Ensure Internet connection is normal when updating. Besides, it may take several minutes when the upgrade task is heavy, please wait patiently.

Chapter 3: Diag Notes

1. Connect VCI Connector

Procedure:

- a) Locate the marine diagnostic socket. Diagnostic socket connectors are inconsistent across models, so it is necessary to use the corresponding adapter of the model. You can check the approximate location of the model adapter in the diagnostic bitmap in the software data.
- b) Plug the diagnostic connector of this device into the diagnostic socket.

2. Diagnosis Flowchart

For new users, please register and log in before using this product. Connect the diagnostic connector →user registration→user login→>download or upgrade software→select function or vehicle type→>proceed diagnosis.

3. Personal Center

This is used to set up and manage account details and to check dealer's information:

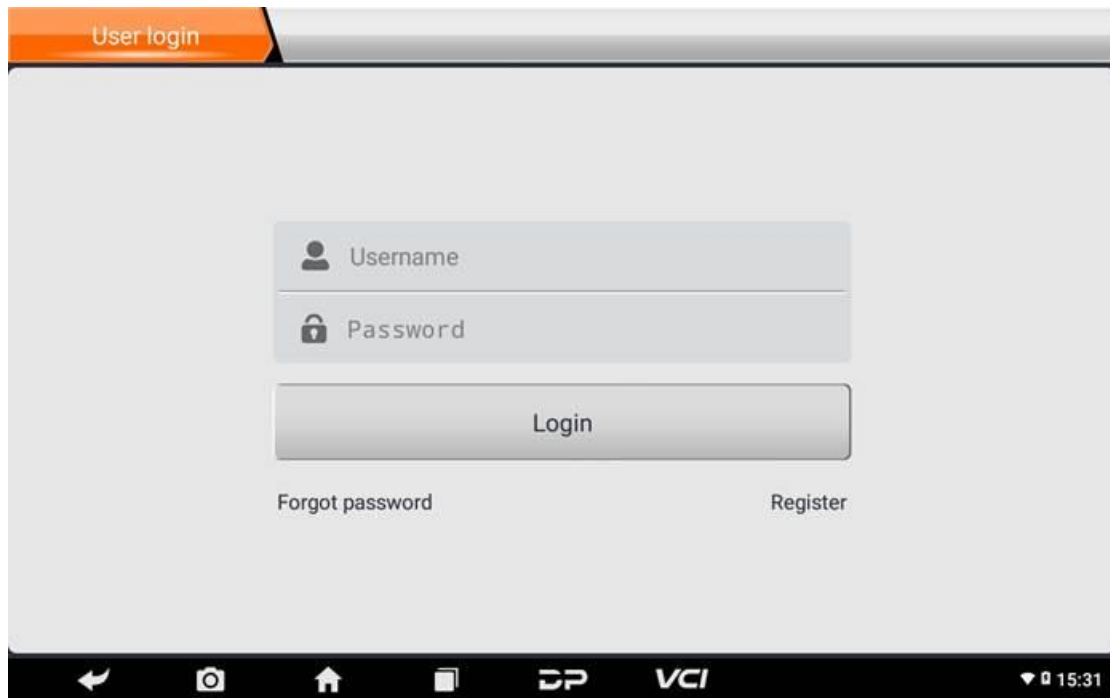

3.1. User Registration

Enter Personal Center, then login interface will be shown. If you are a new user, click the “Register” button in the lower right corner to enter the user registration interface. As shown:

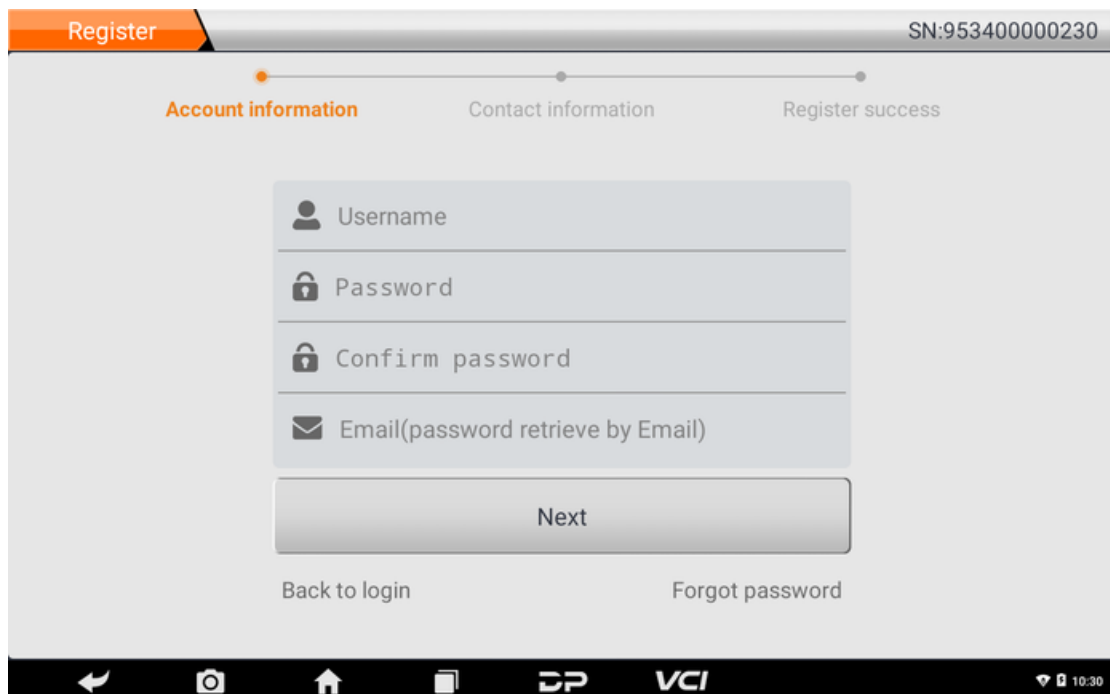

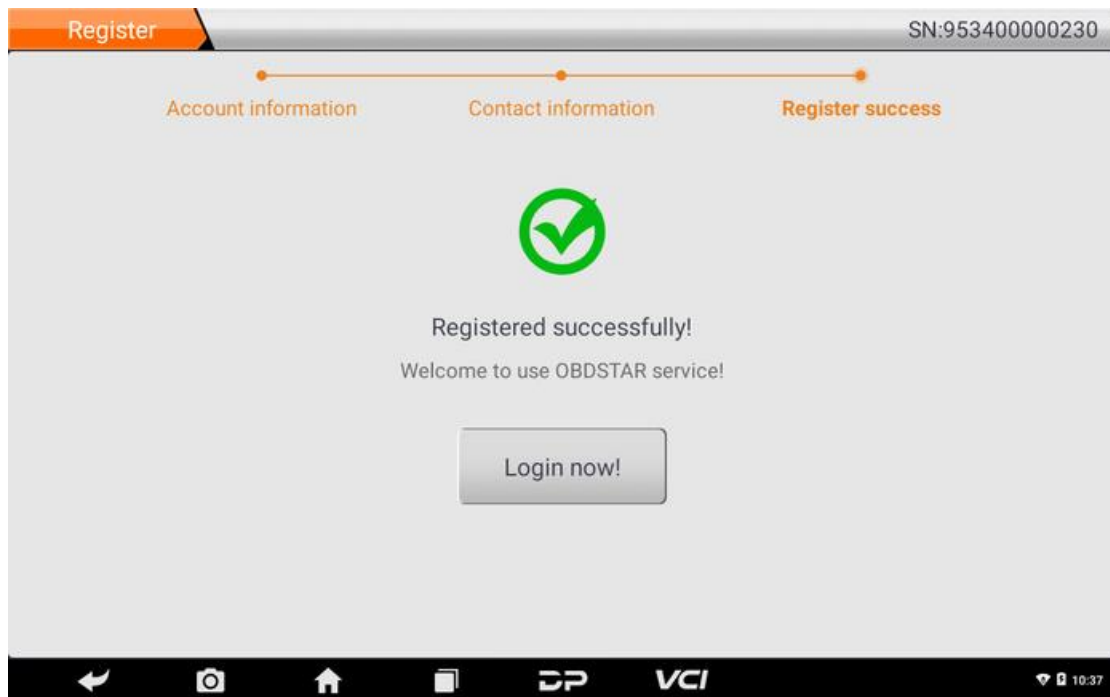
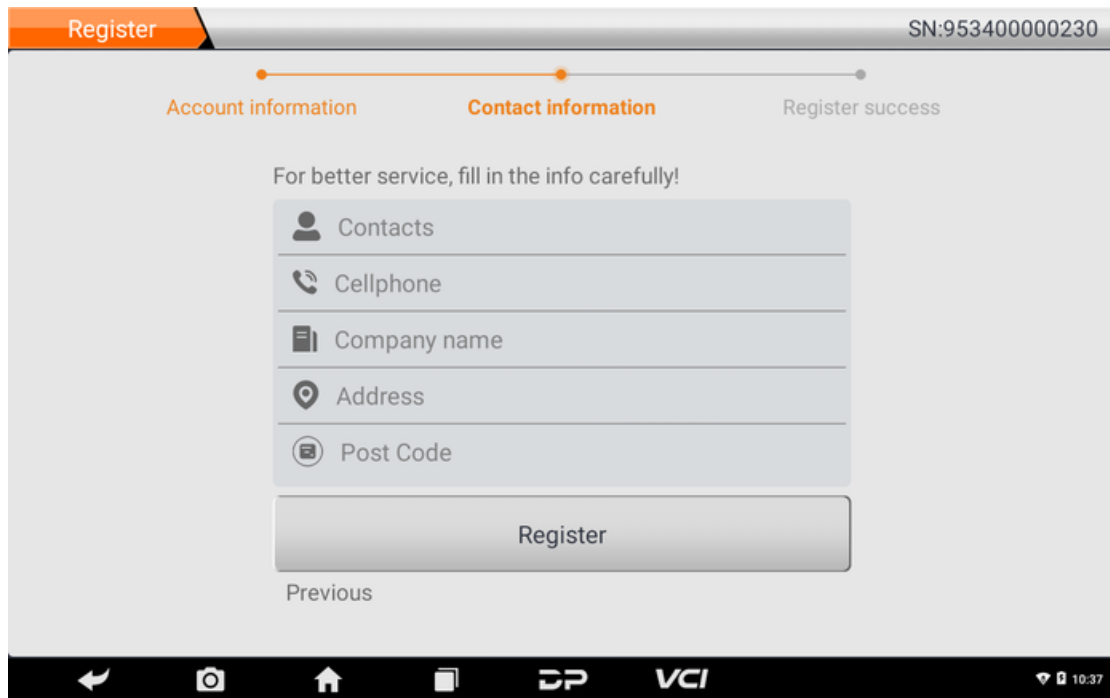

Fill in the information in each field. After that, you will be prompted with “Registered successfully!”. Click “Login now!”

3.2. User Login

If you have already registered as a member, click “User login” to enter user login page. Fill in your account number and password,

then click login. See the picture below:

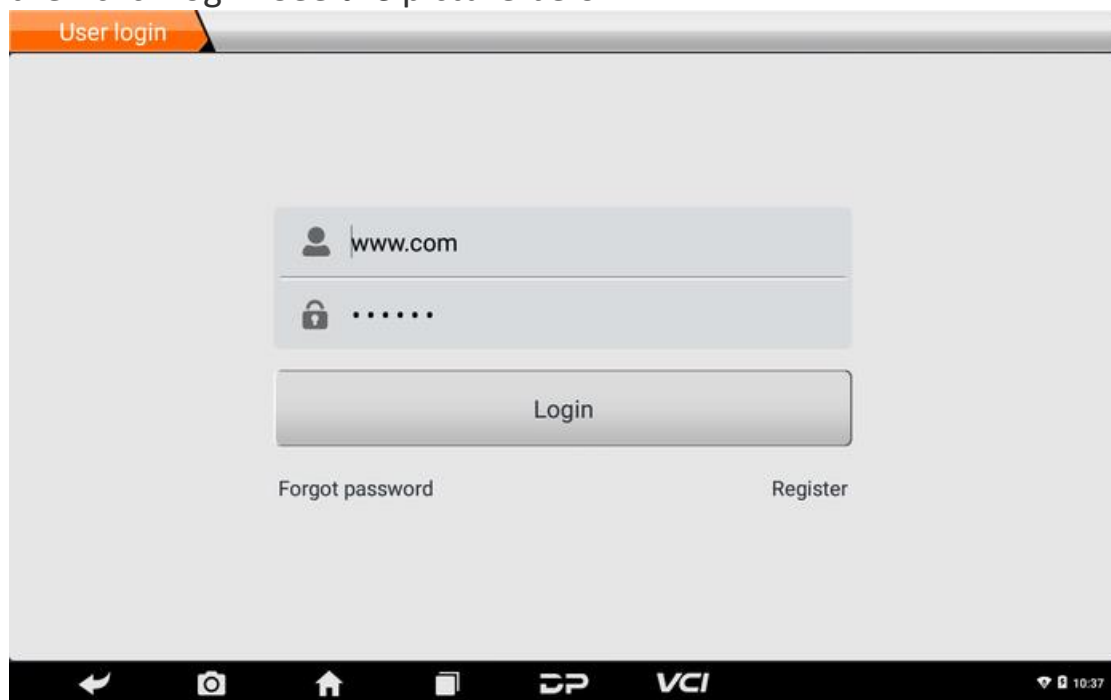

Your personal information will be displayed, and you can modify the information and the password.

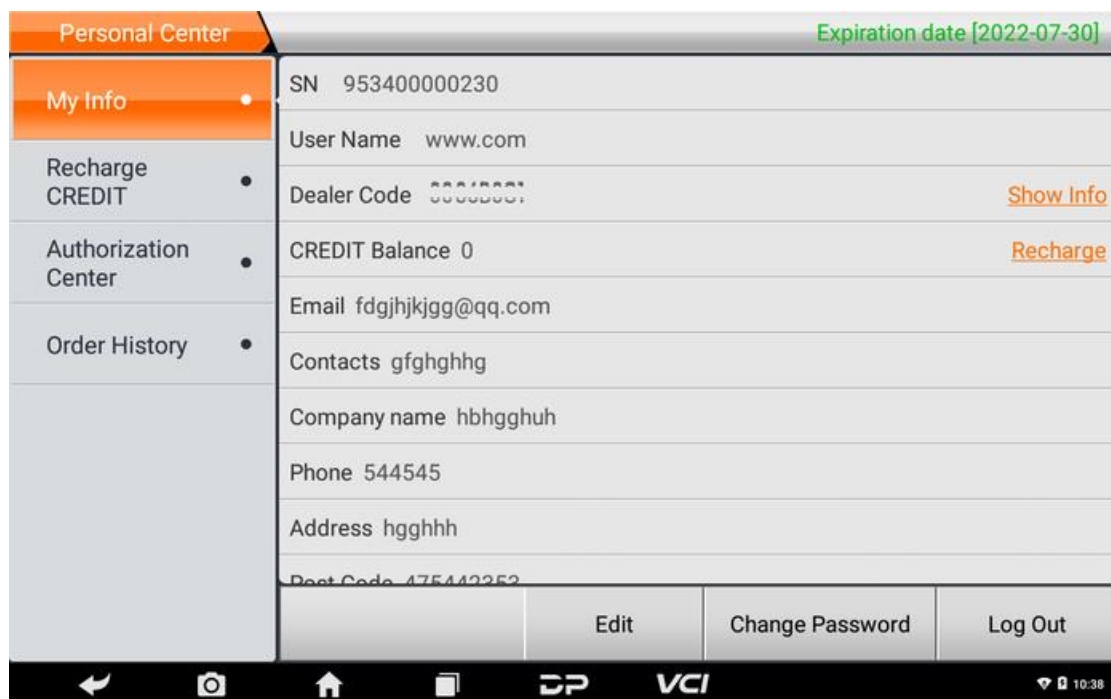

3.3. Edit User Information

Tap the Edit at the bottom of the screen, and you can fill in or modify your information.

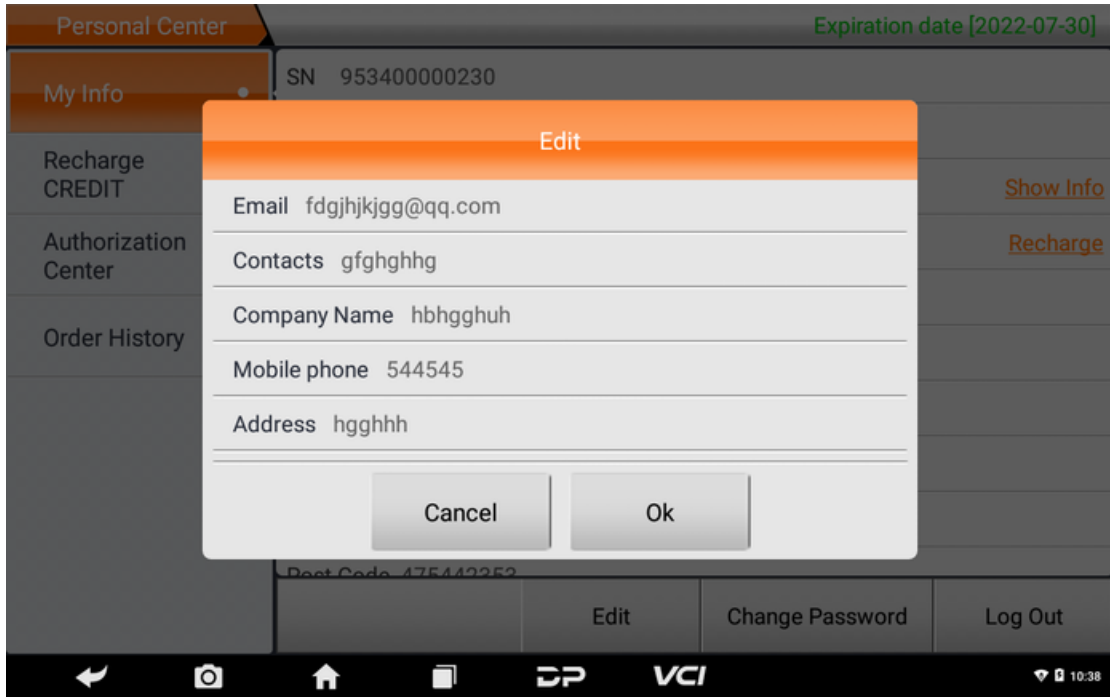

3.4. Change Password



3.5. View Distributor Information

Click "Show Info" in the My Info interface to view Distributor Contact Information.

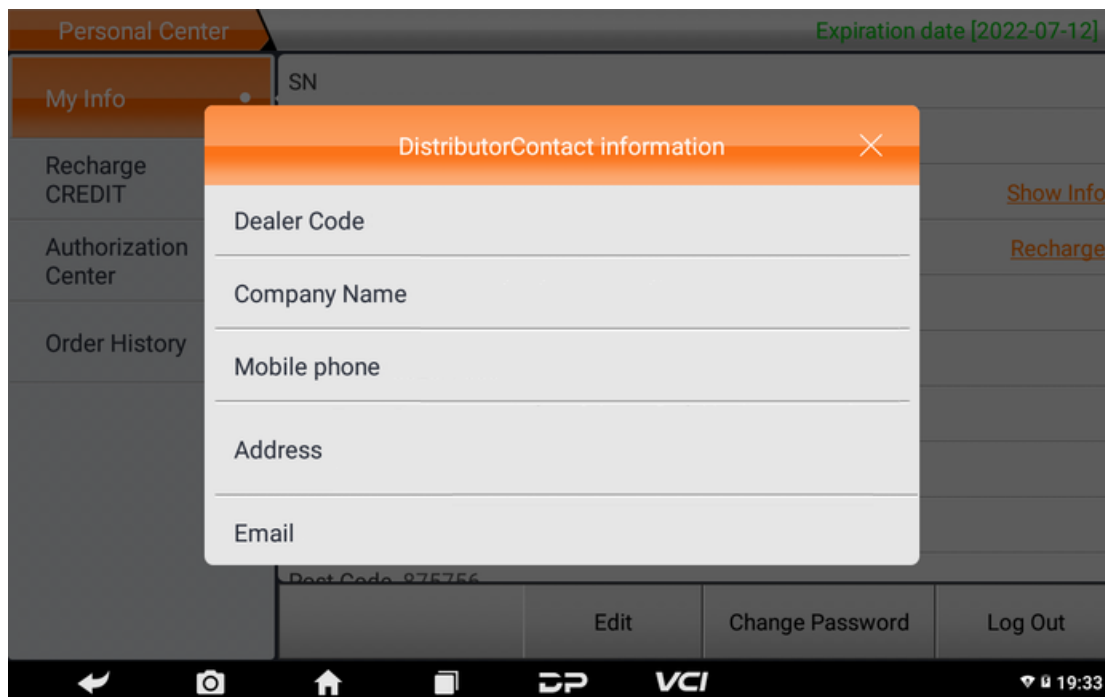

3.6. Recover Password

Click on the forgotten password in the login interface to enter the password recover interface, then fill in the relevant information to recover the password.

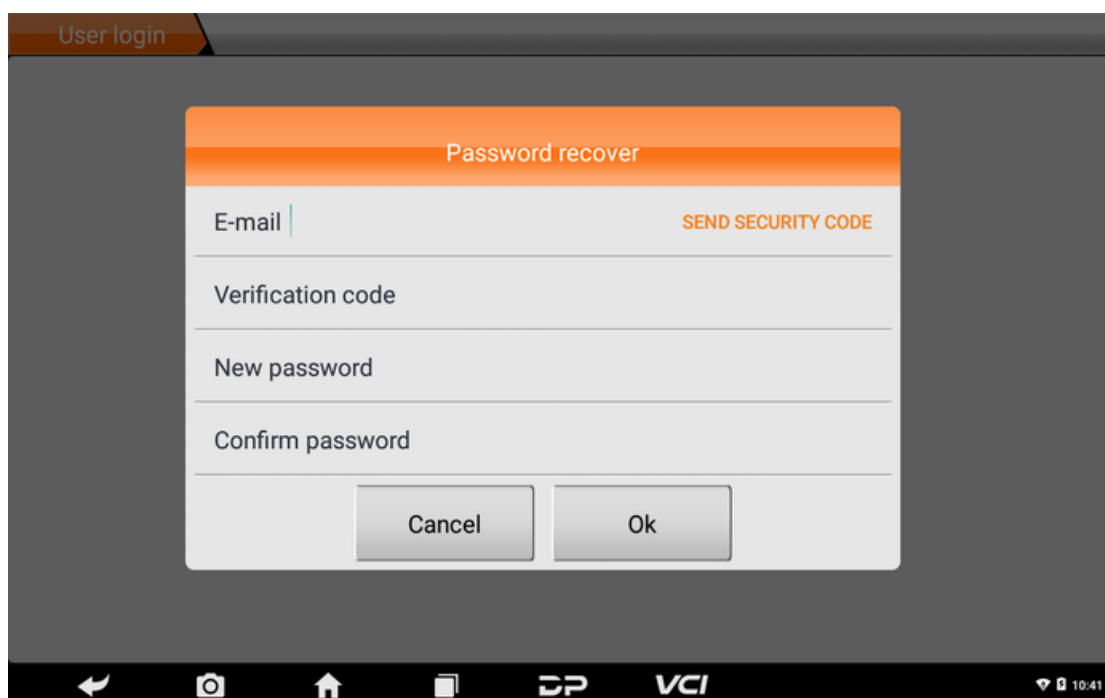

3.7. Recharge CREDIT

Click "Recharge CREDIT", there are two contract methods.

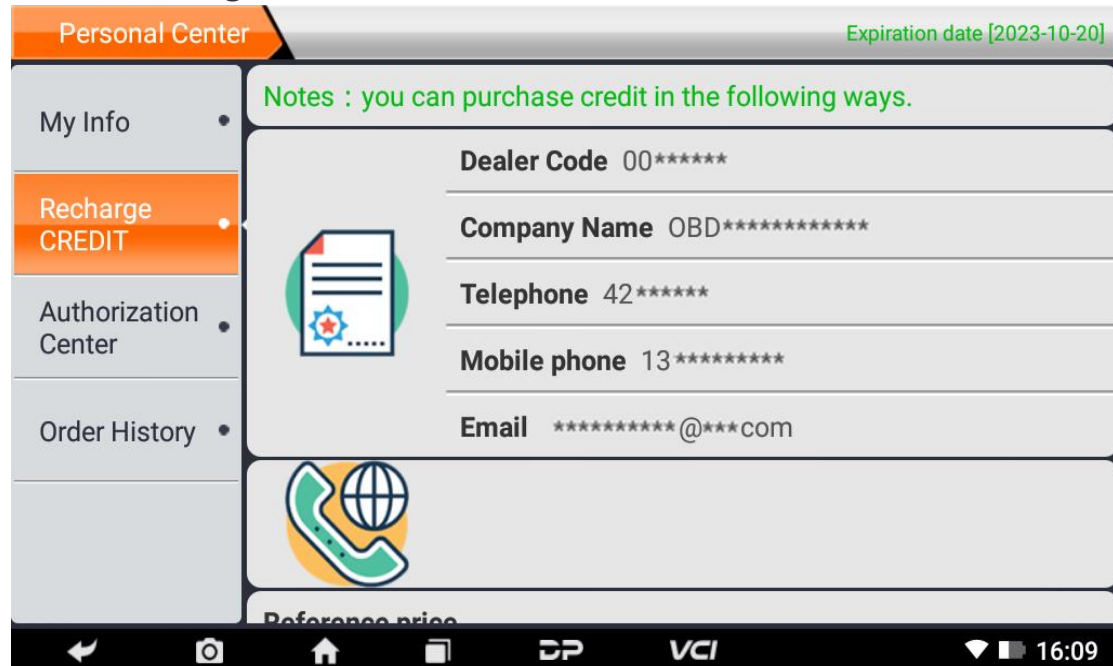

3.8. Authorization Center

Click "Authorization Center" for the Annual Subscription and Upgrade Configuration.

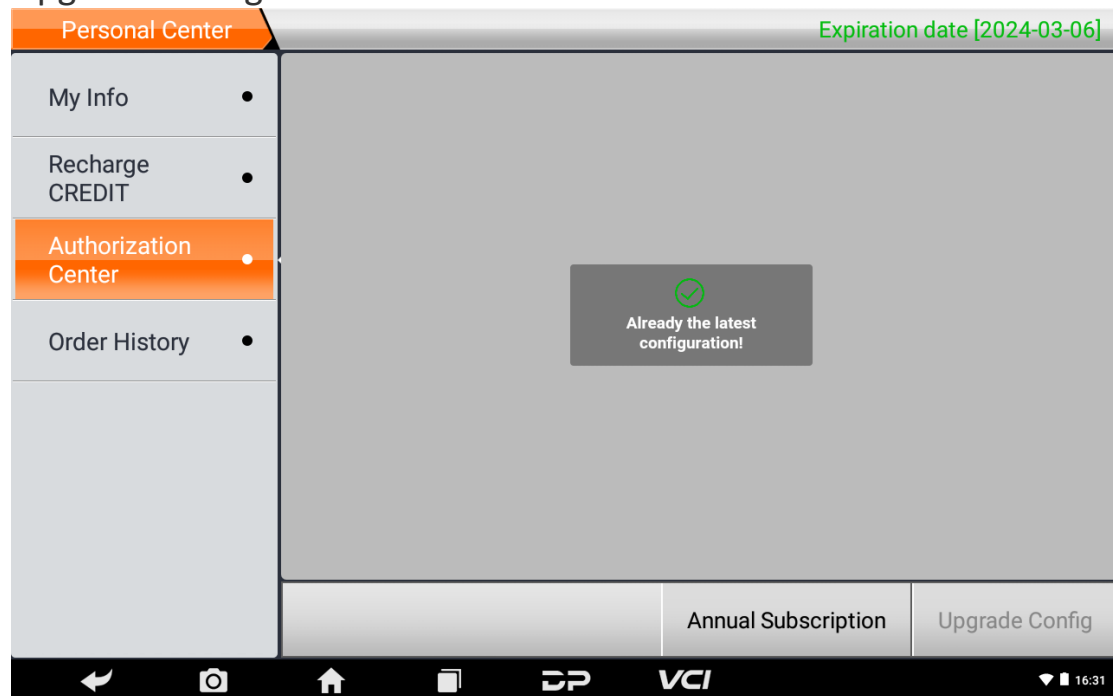

Choose the desired period to recharge.

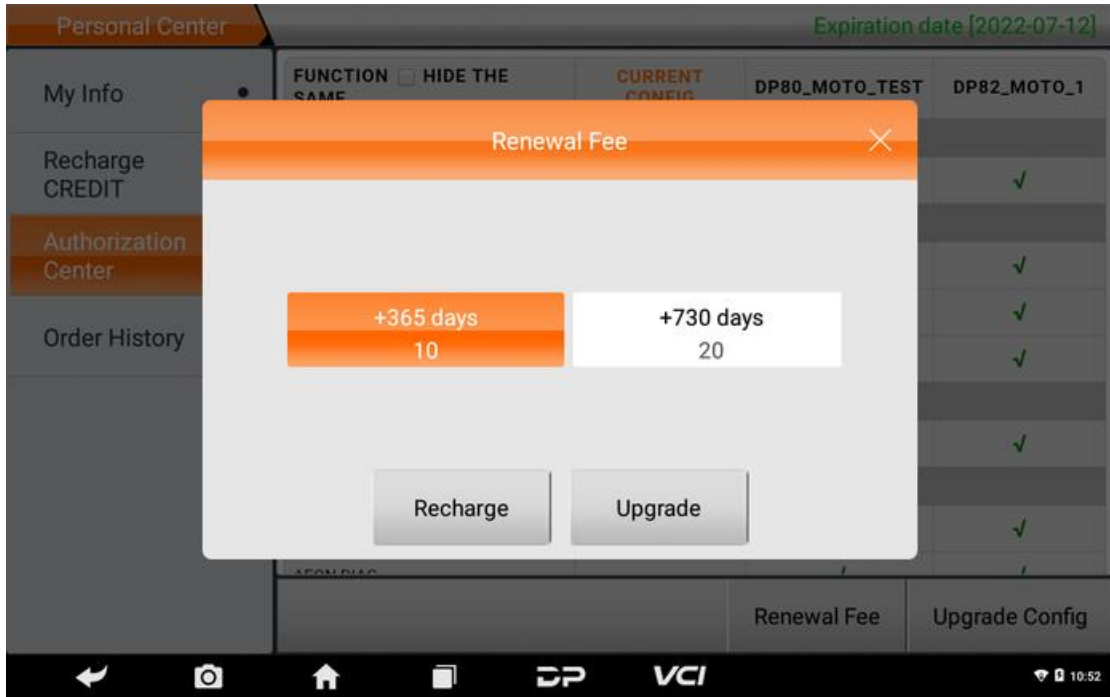

Choose the configuration you would like to upgrade.

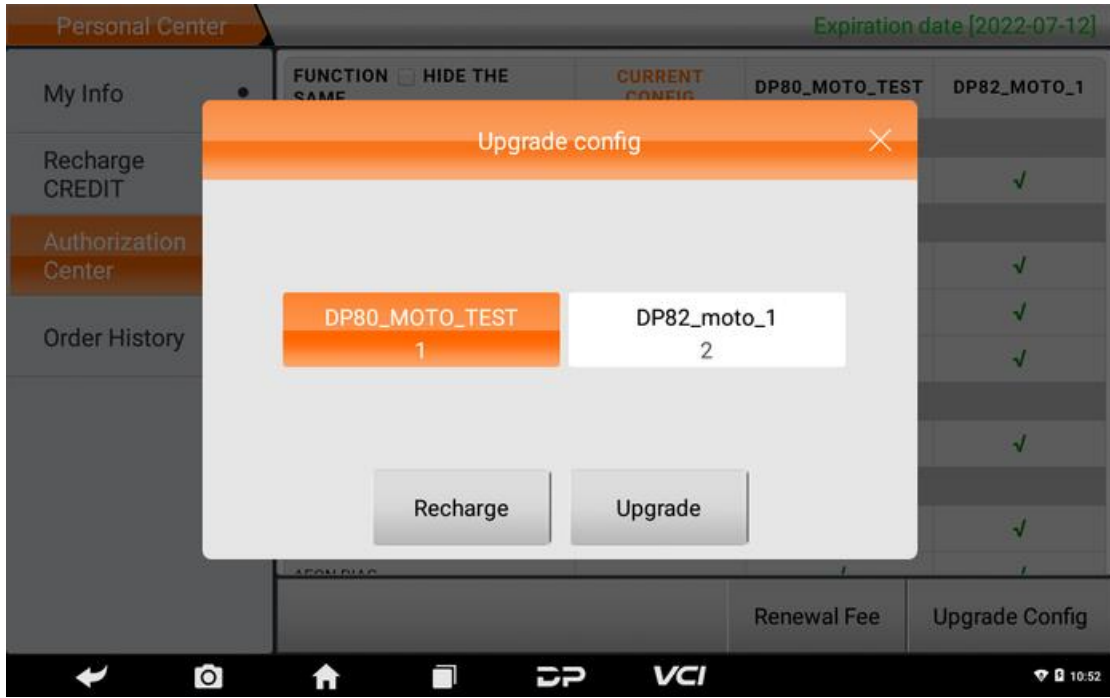

3.9. Order History

Click "Order history" to view the history of orders.

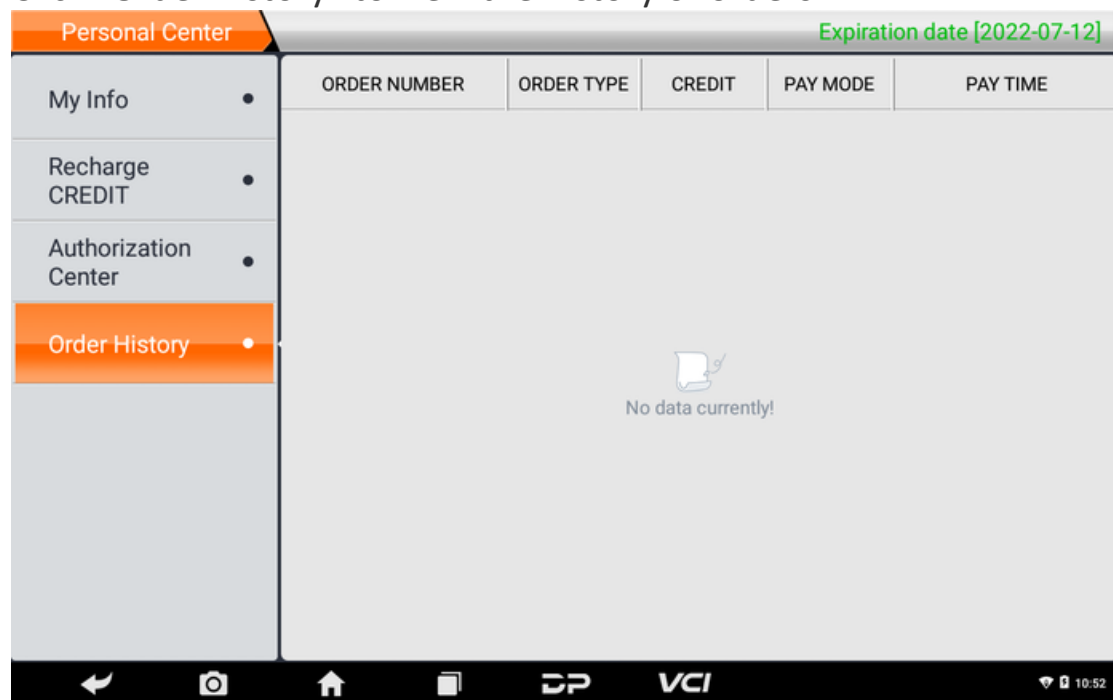

4. Diagnostic Software Main Interface Introduction

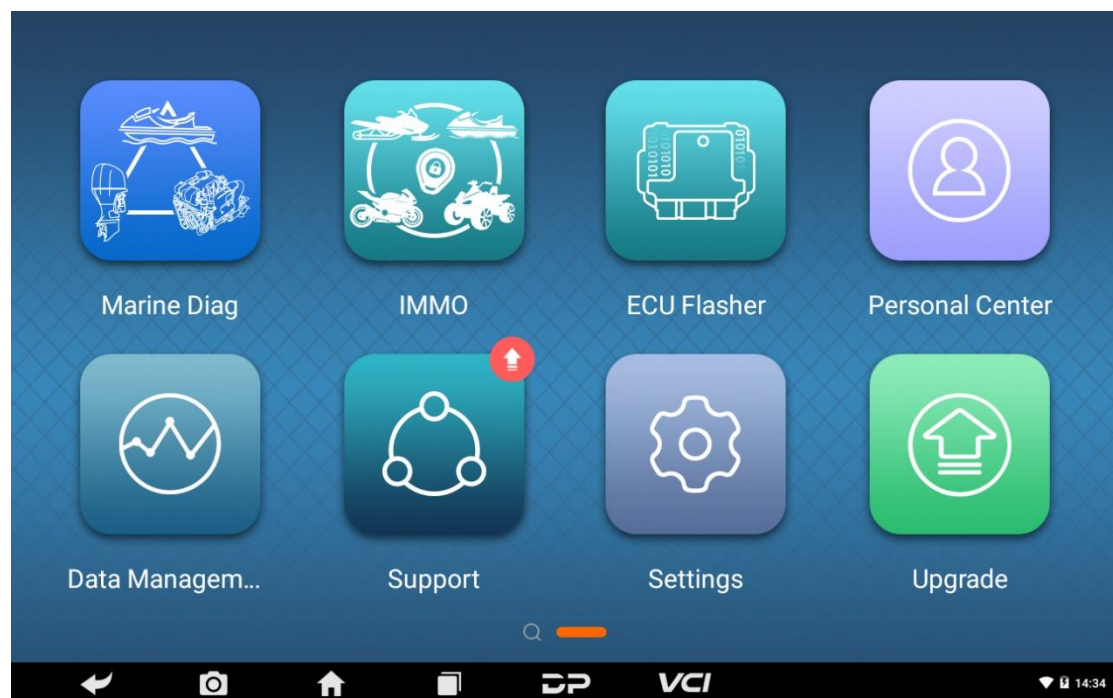

The main interface contains the following functions:

FUNCTIONS	DESCRIPTIONS
MARIEN DIAG	To enter the maritime diagnostic programming function.
IMMO	To enter the anti-theft programming function.
ECU Flasher	To enter ECU Flasher function.
Personal Center	It includes new user registration, login, user information management, dealer information inquiry, etc.
Data Management	Includes My Data, Data playback, Uninstall Model, Diagnose Report, Picture Viewer and File Management.
Support	Includes Video, Manual, FAQ, Log Upload, Team Viewer and Abnormal Feedback.
Settings	It includes VCI Info, Language, Unit, Network Test, Clear Cache, System Settings, About.
Upgrade	To download diagnostic software or upgrade diagnostic software to the latest version.

5. Start Diagnosing

5.1. Supported Brands

Click "Marine Diag" in the main interface to enter model selection interface, and you will enter the "All" menu path by default. See below:



Select the Favorites menu, click "+" to enter the interface of marine brand options of each area. Check the box in the upper right corner of the brand logo, and then click "Add" in the upper right corner of the interface to add the brand to Favorites.

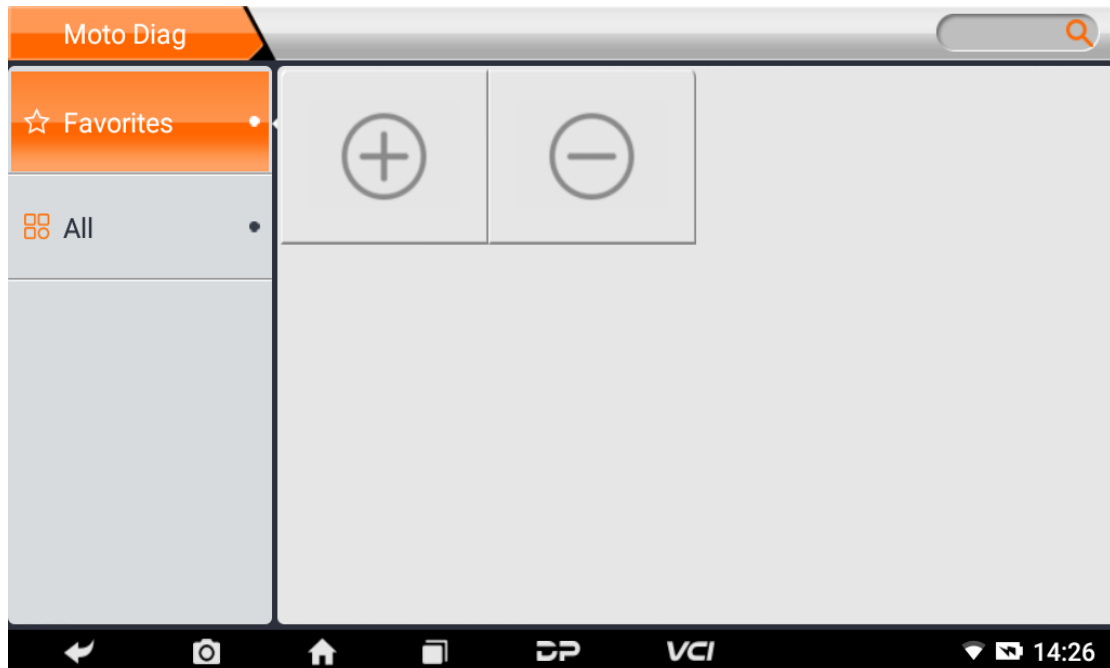

If you want to delete your favorite marine series from Favorites, click "-" to enter the interface of your favorite marine series. Check the box in the upper right corner of the brand name logo, and then

click "Delete" in the upper right corner of the interface to delete from Favorites.



Select from the menu, you can see all the downloaded software configured in this device.

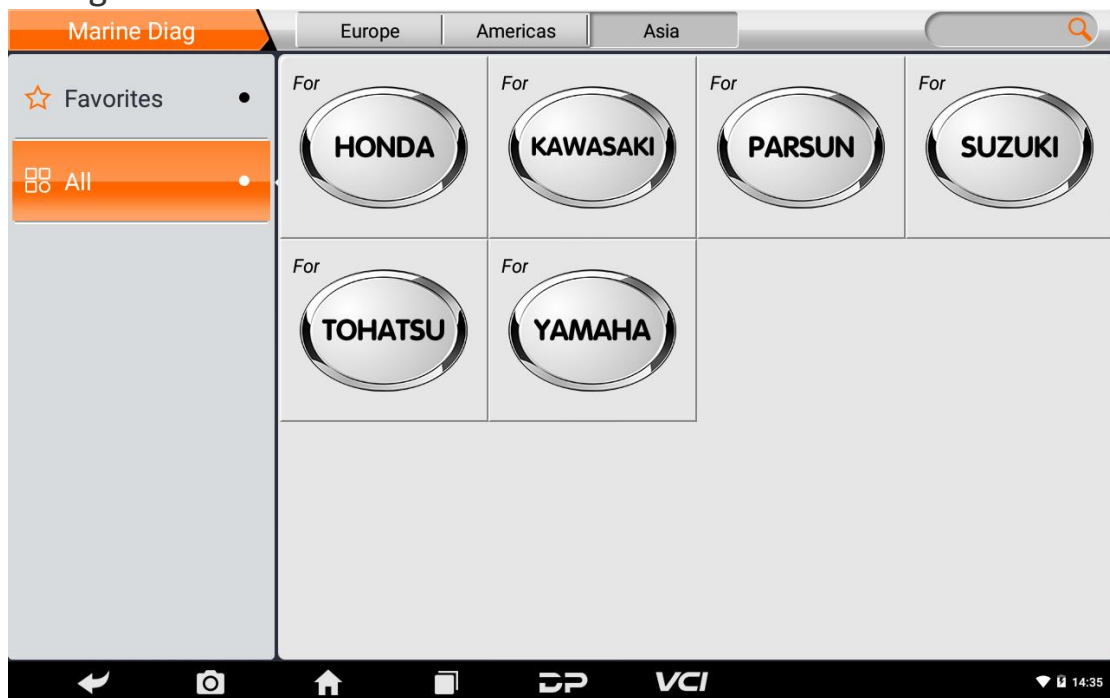

5.2. Diagnosis

The following example of HONDA demonstrates how to start the diagnosis. From All menu, select Asia and click the "HONDA" brand

name box. See below:

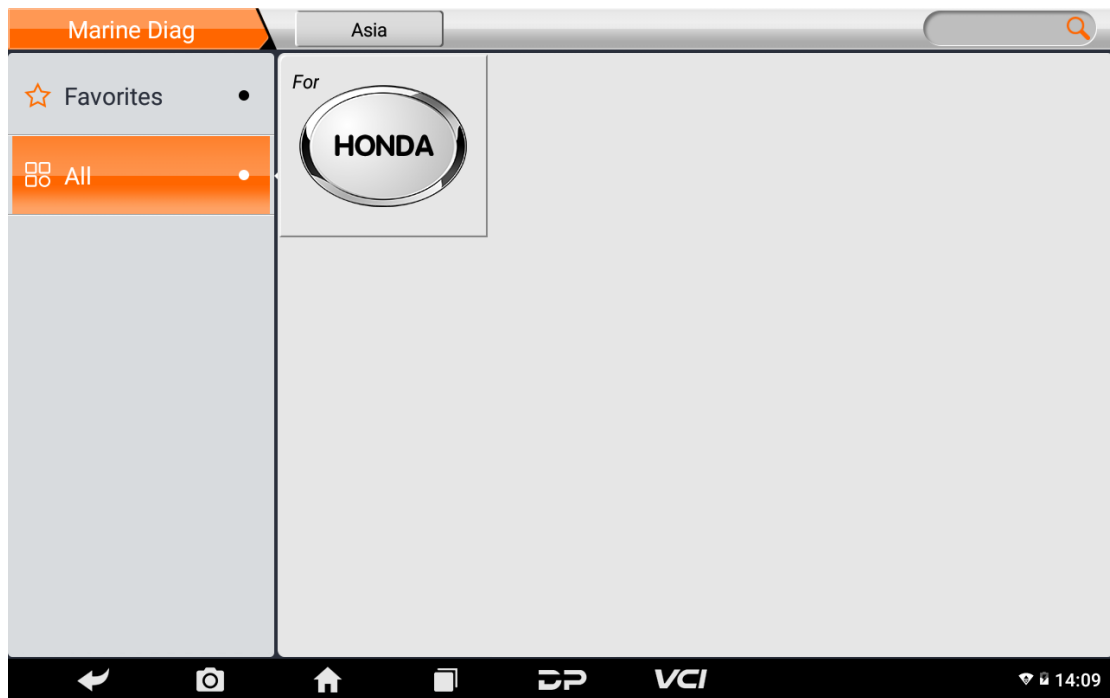

Then, select the software version:

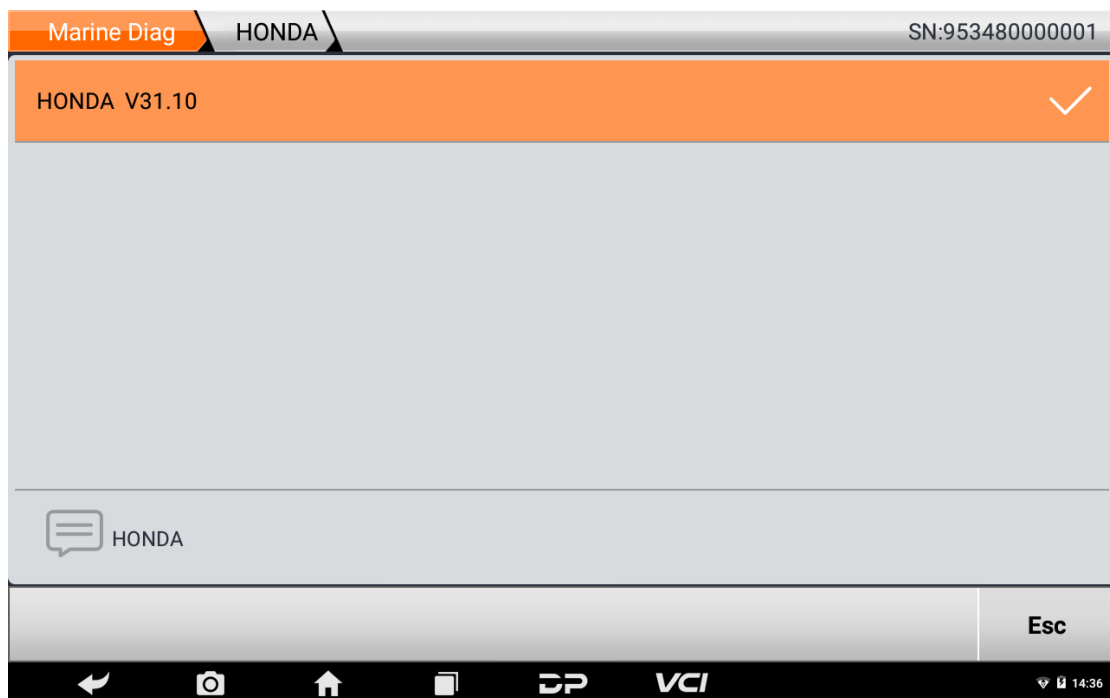

Enter the diagnostic function menu:

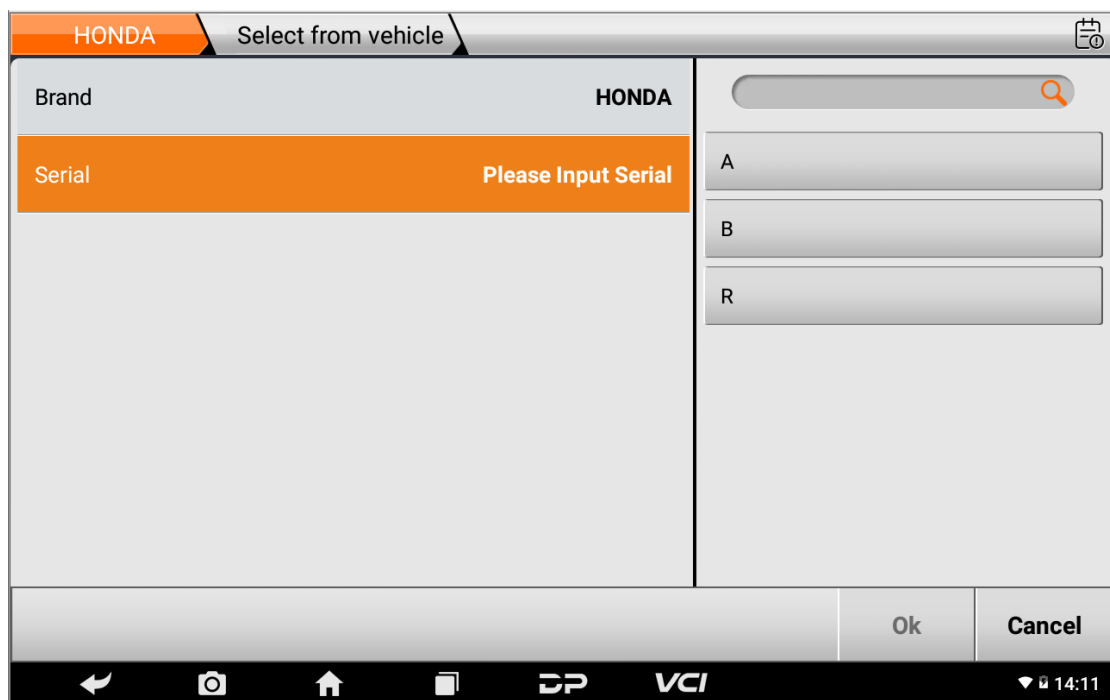

You can select models by Alphabet or input the Model name and search. Here's the example of Aqua Trax F-12(ARX1200N3) 1235 PWC(Personal Watercraft)|(2004-):

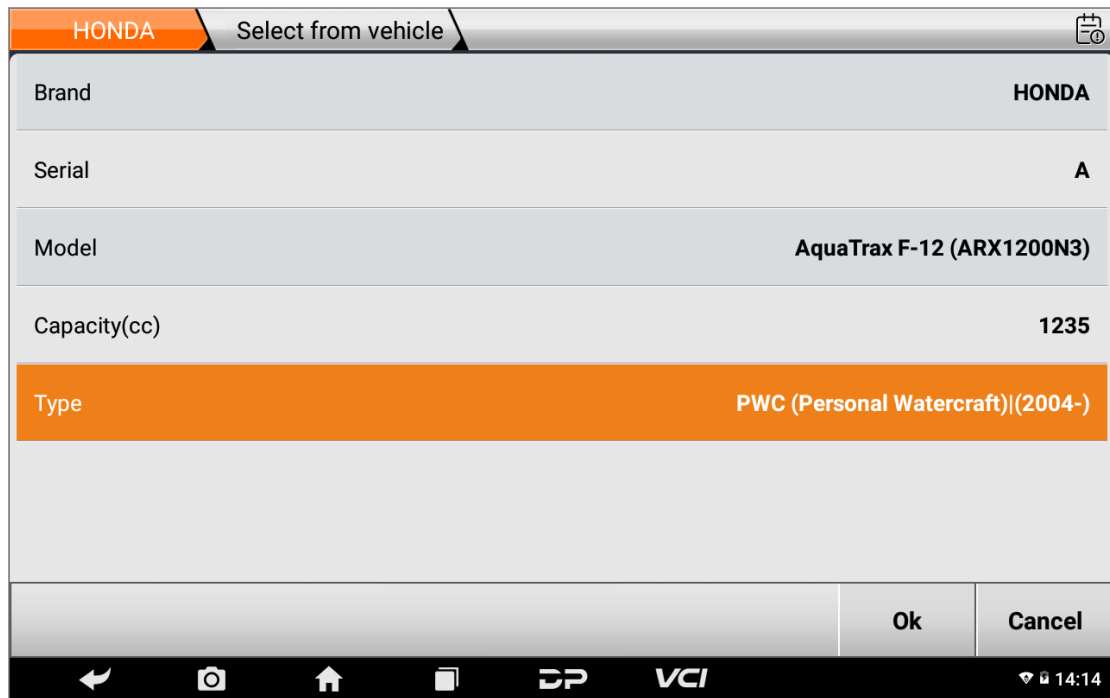

Click OK and click ENG to enter the function menu. See image:



5.2.1 DTC

HONDA		DTC		
DTC Code	DTC Description	State	Maintenance Guide	
00-05	ECM COMMUNICATION FAILURE			
00-08	ECM COMMUNICATION FAILURE			
00-02	ECM INITIAL CHECK FAILURE			
			Back	

All historical fault codes:

HONDA		All DTC History		
DTC Code	DTC Description	State	Maintenance Guide	
41-04	Latest Record-A/F SENSOR HEATER FAILURE			
41-03	2nd new record-A/F SENSOR HEATER FAILURE			
41-04	3rd new record-A/F SENSOR HEATER FAILURE			
41-03	4th new record-A/F SENSOR HEATER FAILURE			
41-04	5th new record-A/F SENSOR HEATER FAILURE			
			Back	

5.2.2 Read Data Stream

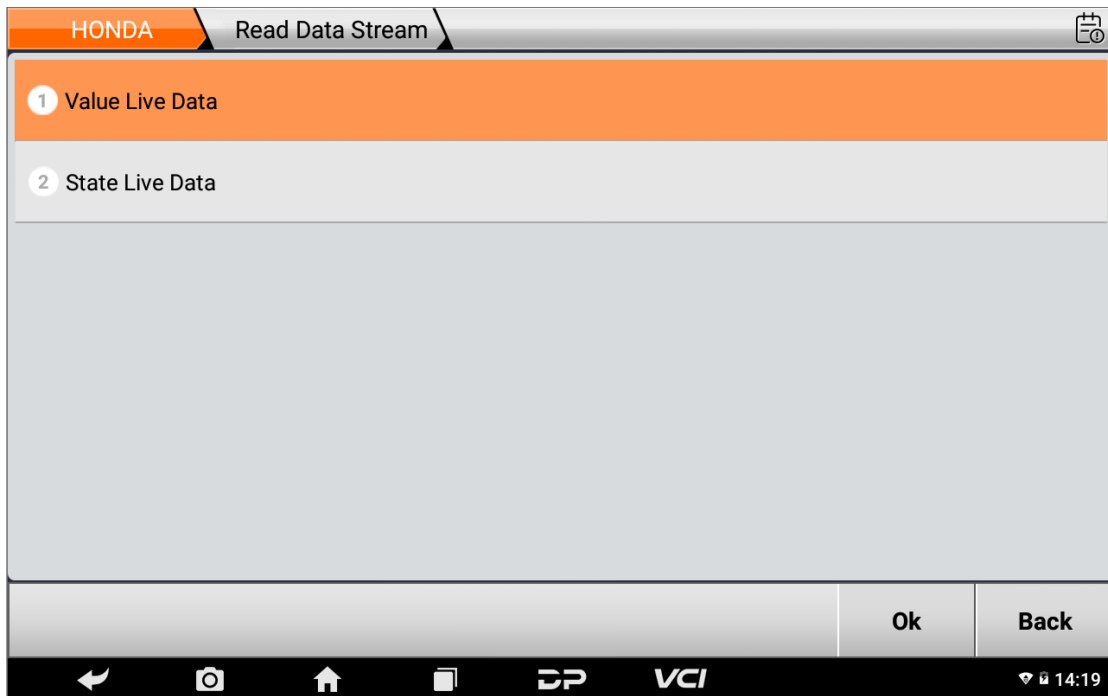

Value Live Data:

<input type="checkbox"/> Name 0/64	Value	Range	Unit	⚙️
<input type="checkbox"/> TP SENSOR	0.45	[0.10...4.92]	V	⌵
<input type="checkbox"/> TP SENSOR	0.0		deg	⌵
<input type="checkbox"/> ECT SENSOR 1	3.06	[0.08...4.92]	V	⌵
<input type="checkbox"/> ECT SENSOR 1	22		degC	⌵
<input type="checkbox"/> ECT SENSOR 1	71.6		degF	⌵
<input type="checkbox"/> IAT SENSOR	3.00	[0.08...4.92]	V	⌵
<input type="checkbox"/> IAT SENSOR	23		degC	⌵

State Live Data:

HONDA		State Live Data		
<input type="checkbox"/> Name 0/13	Value	Range	Unit	
<input type="checkbox"/> VTEC SOLENOID	OFF			▼
<input type="checkbox"/> A/F SENSOR RLY	ON			▼
<input type="checkbox"/> NP SWITCH	ON			▼
<input type="checkbox"/> SCS	OFF			▼
<input type="checkbox"/> EMERGENCY SW				▼
<input type="checkbox"/> STARTER SWITCH				▼
<input type="checkbox"/> WATER SEPARATOR				▼

list instrument diagram top freeze record video Esc

← [Camera] [Home] [App] [VCI] 17:42

5.2.3 Active Test

Here's the example of Igniter 1 Test

HONDA		Igniter 1 Test		
	Igniter 1 Test			
	Igniter 'ON' test Note: Perform this function test in the condition that the ignition switch is ON and the engine is NOT running.			
Data Stream	ON			Cancel

← [Camera] [Home] [App] [VCI] 14:40

5.2.4 Special Functions

Special functions vary by model. Here's the example of HONDA:

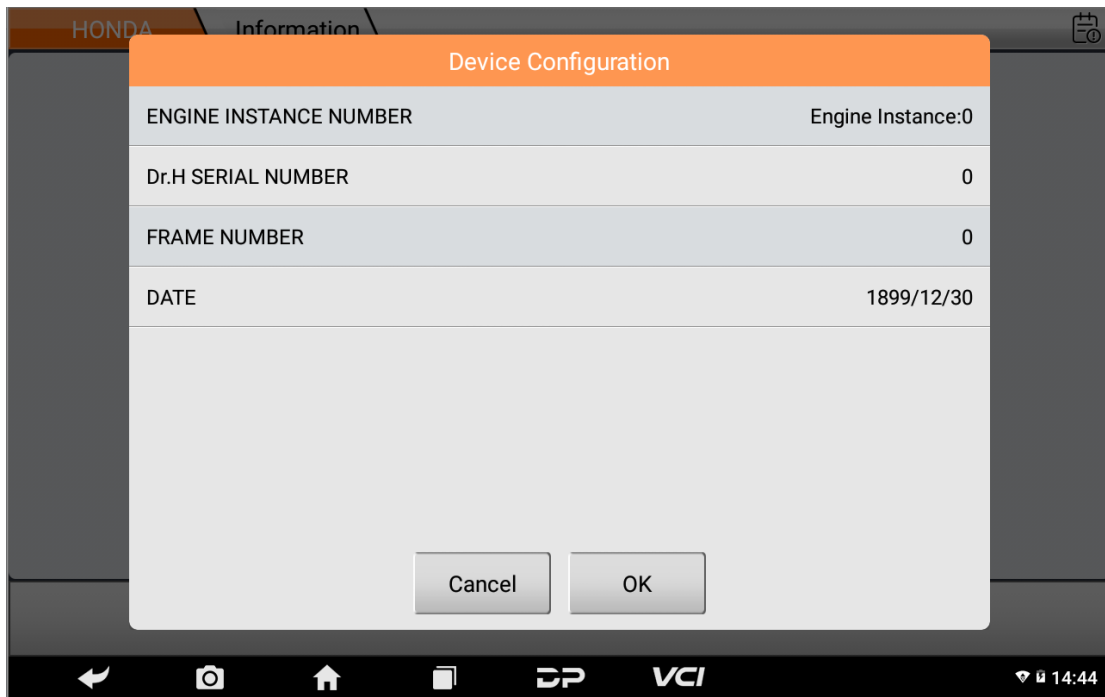
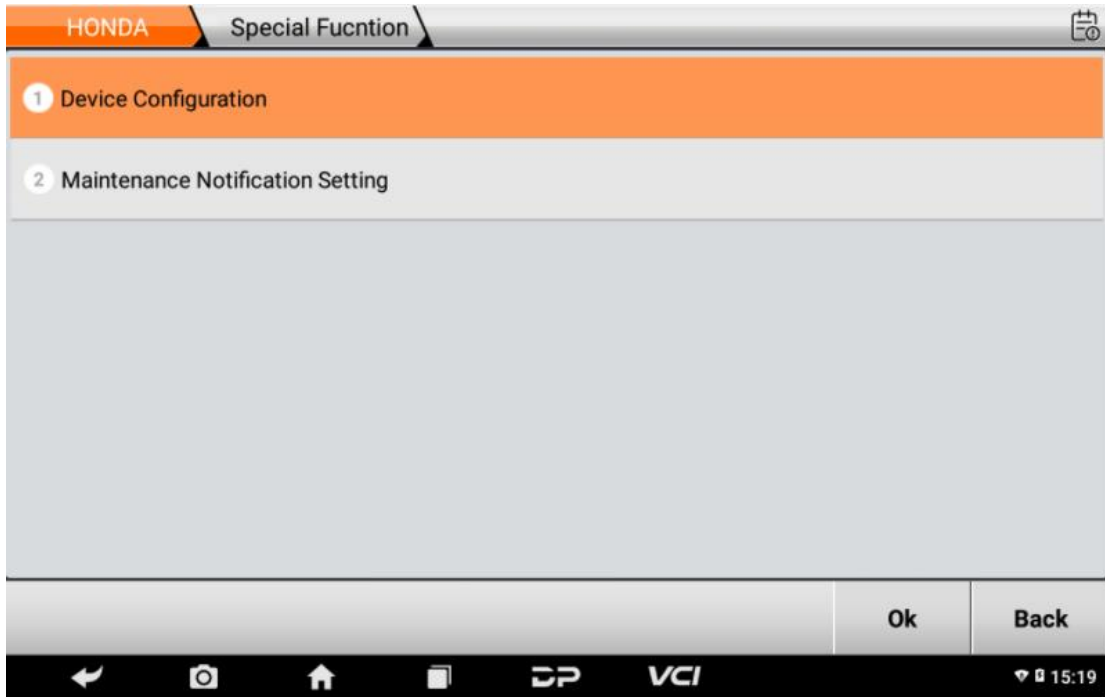

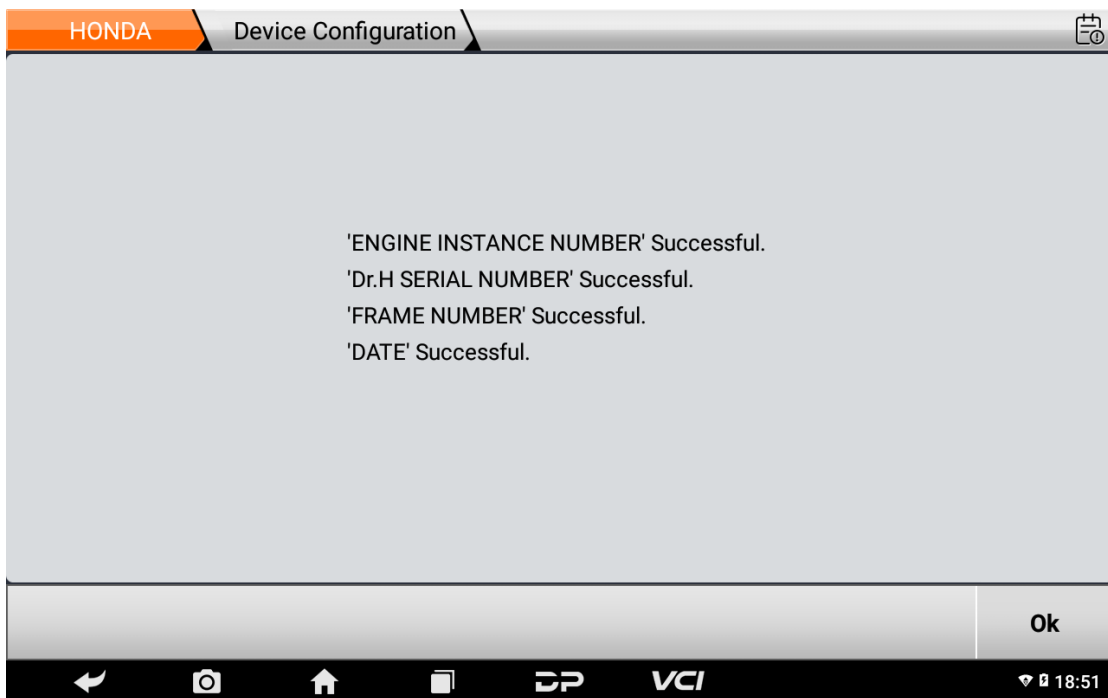
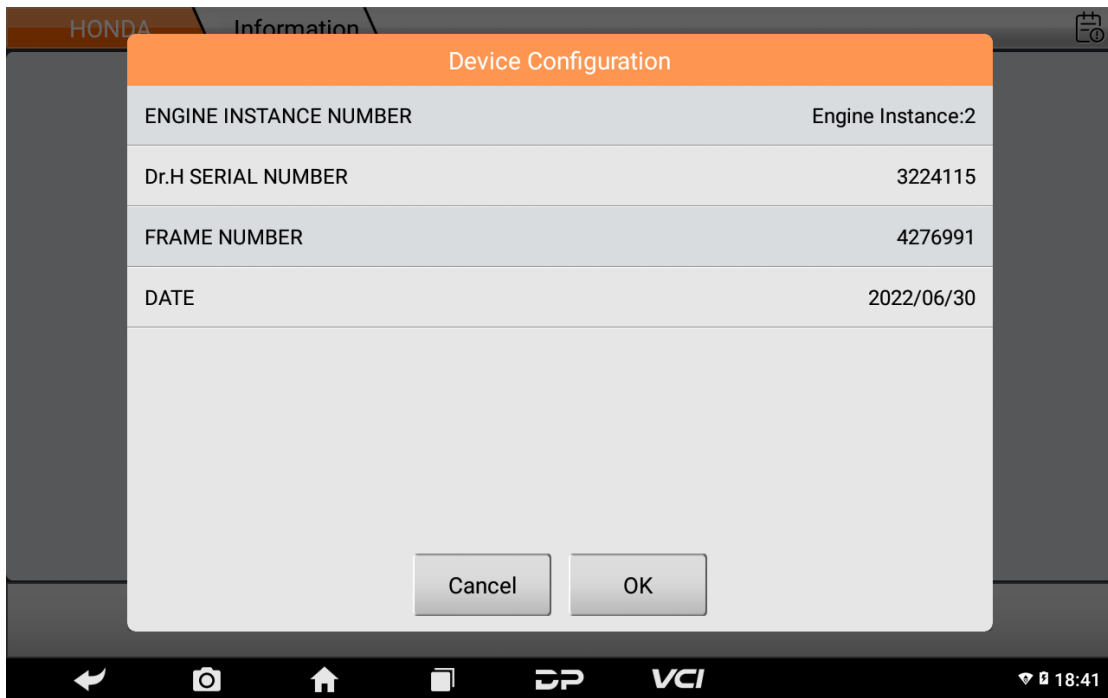

Maintenance Notification Setting

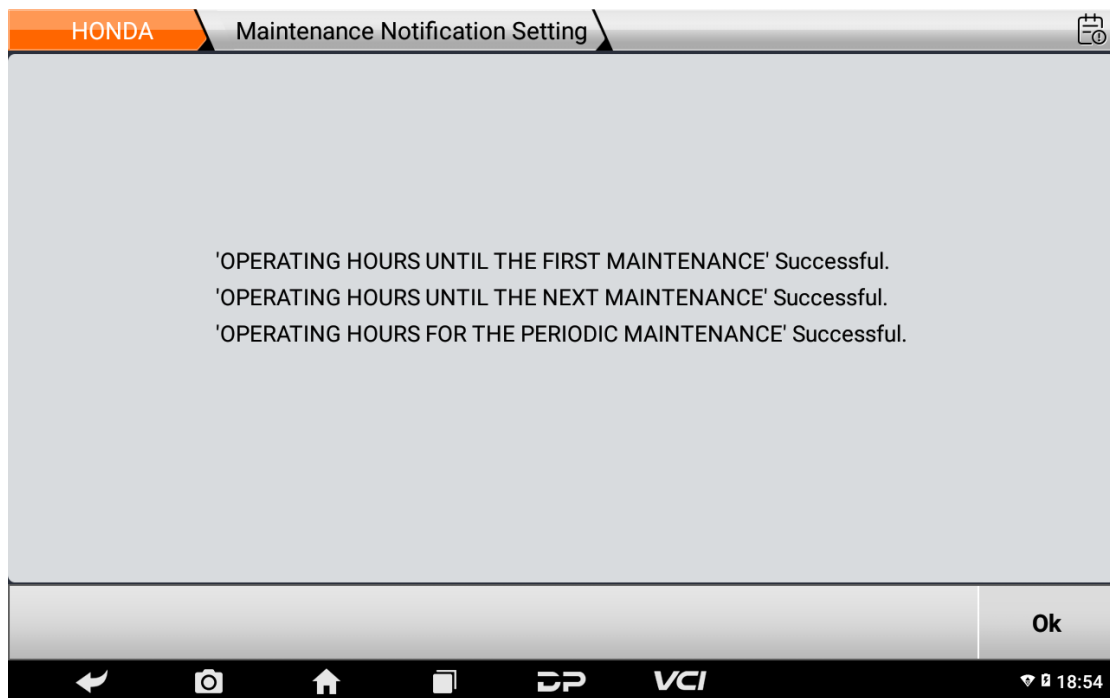
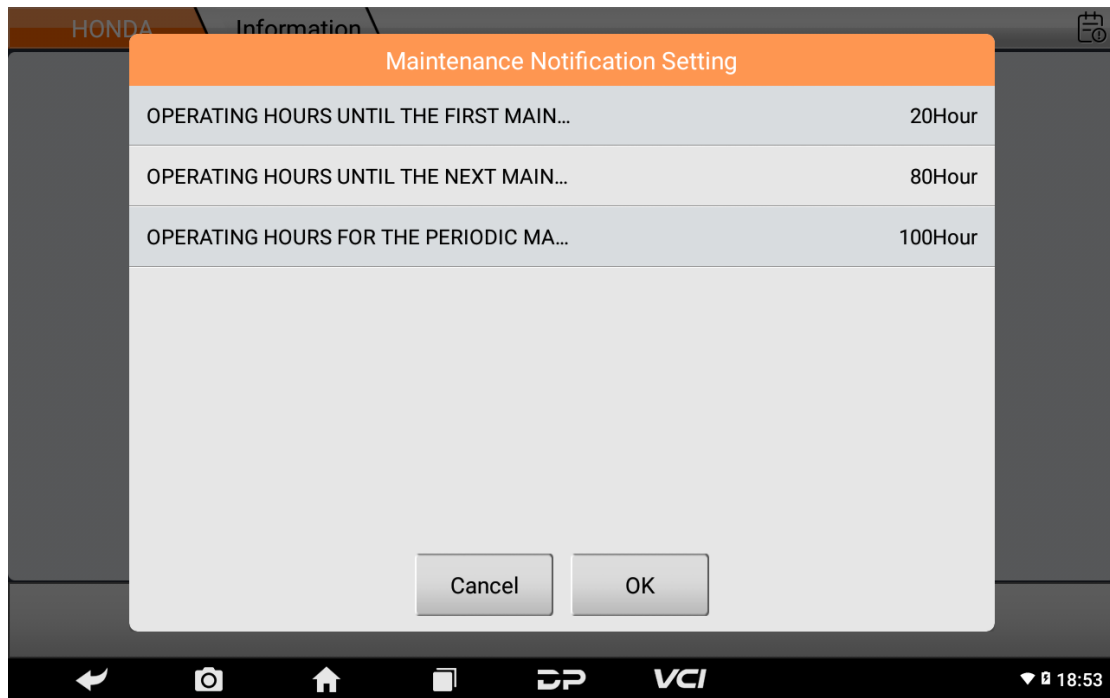

5.3. Interactive Circuit Diagrams

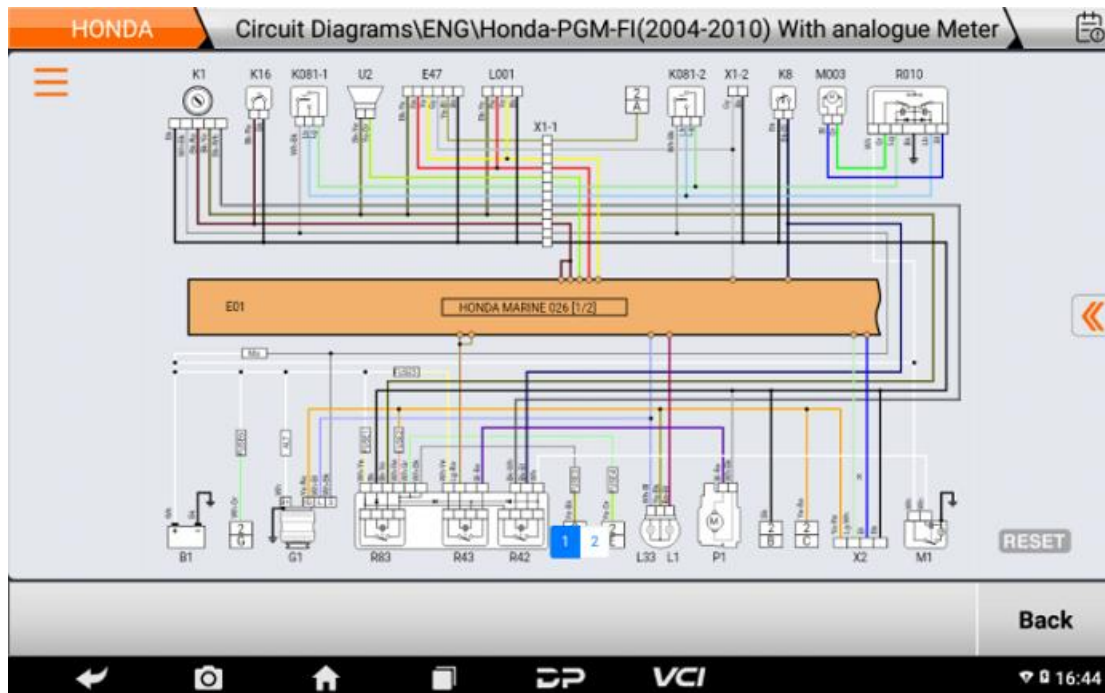

6. Data Management

You can enter My data, Data Playback, Uninstall Model, Diagnose Report, Picture Viewer and File Management.



6.1. My Data

You can view the local backup data and user mobile USB disk.

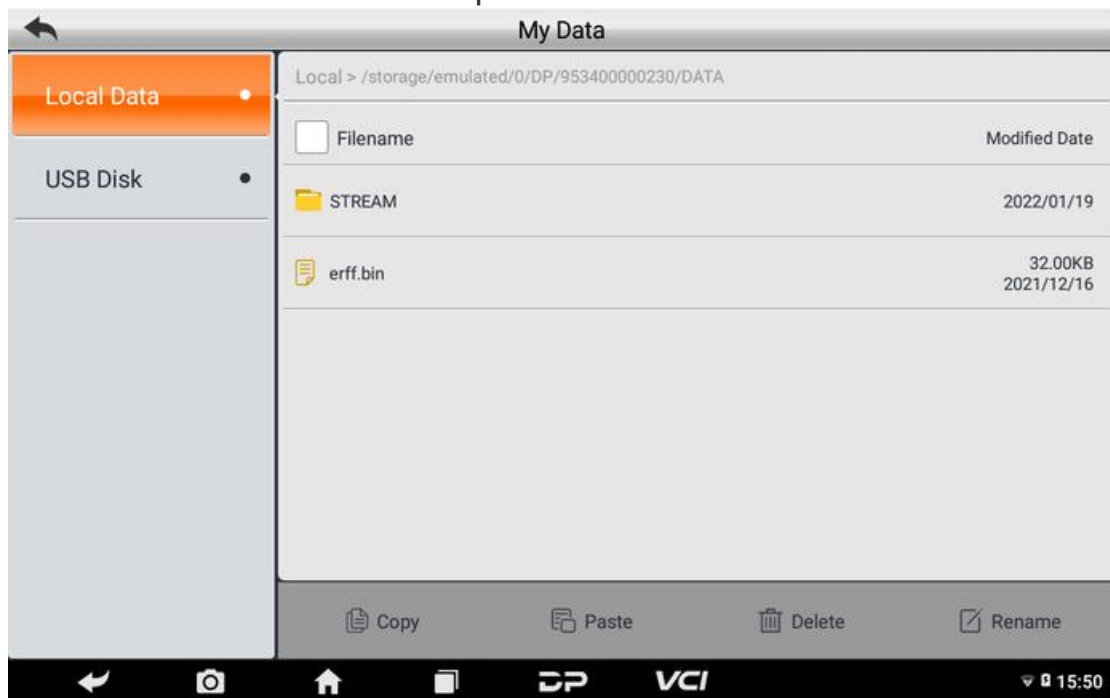

6.2. Data Playback

Data stream has the function of recording and playback, which can realize dynamic data comparison in the same interface, and can easily and quickly find the abnormal data.

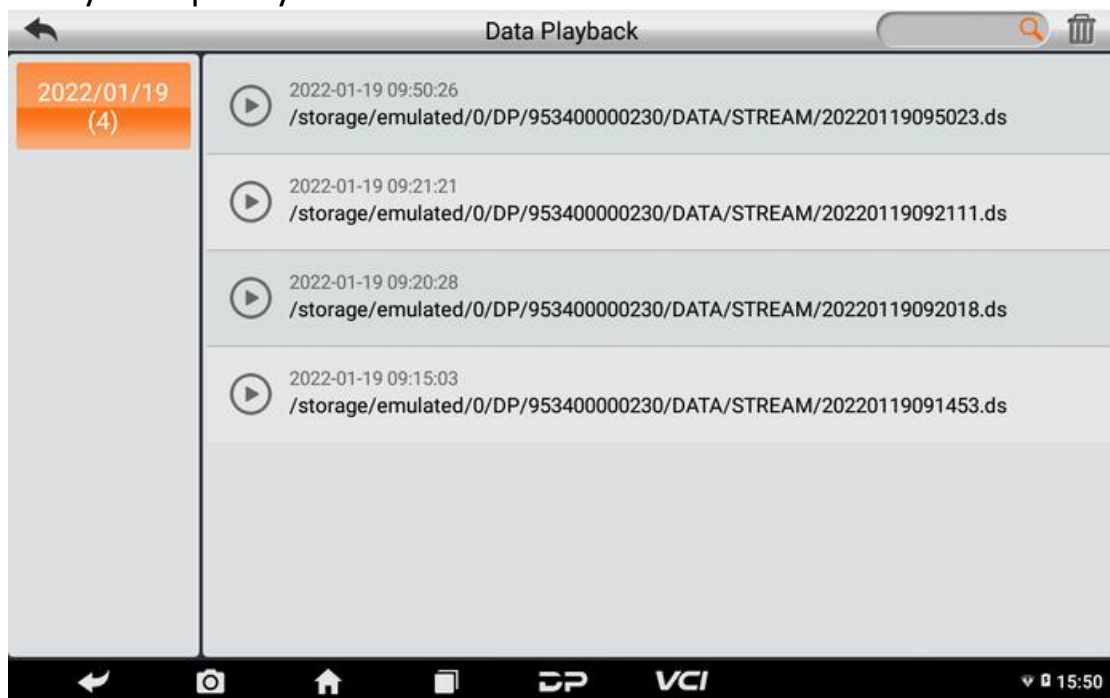

6.3. Uninstall Model

You can uninstall related models;



6.4. Diagnose Report

You can view diagnostic reports.



6.5. Picture Viewer

You can browse the related pictures saved in this device.

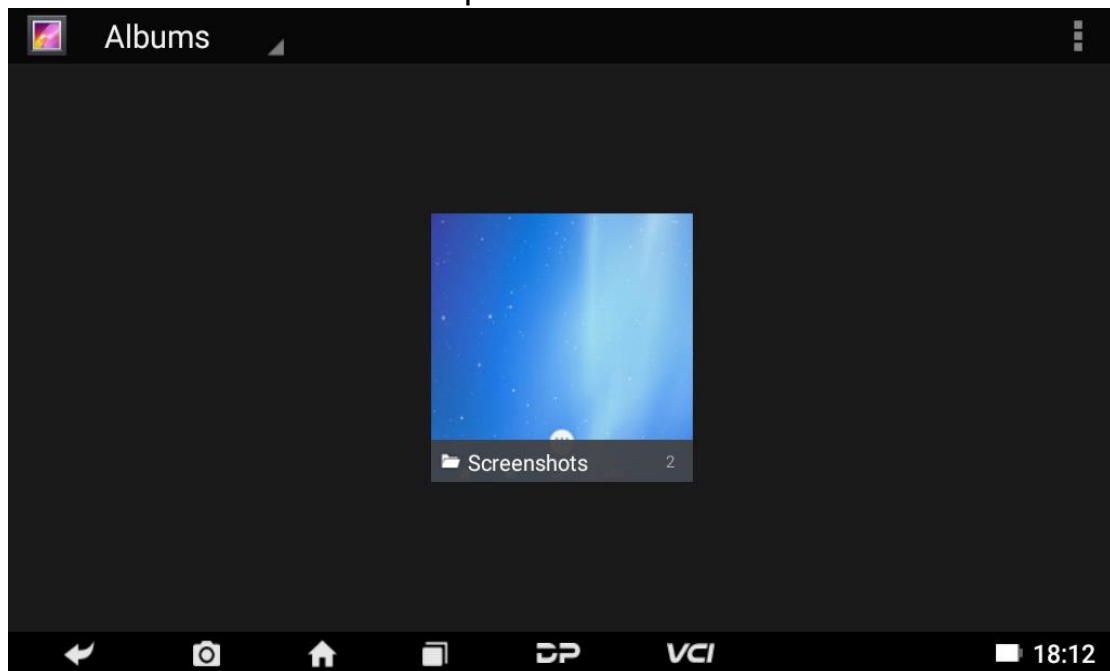

6.6. File Management

You can check the related information in the files.

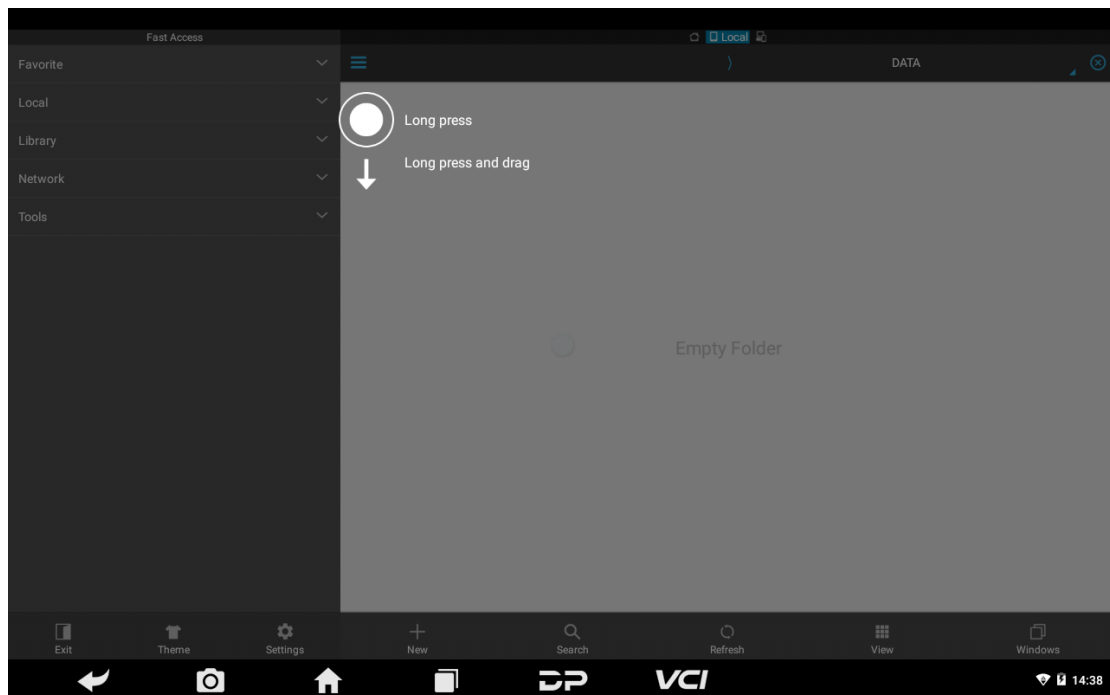

7. Support

We have a powerful maintenance database and detailed product introduction information.

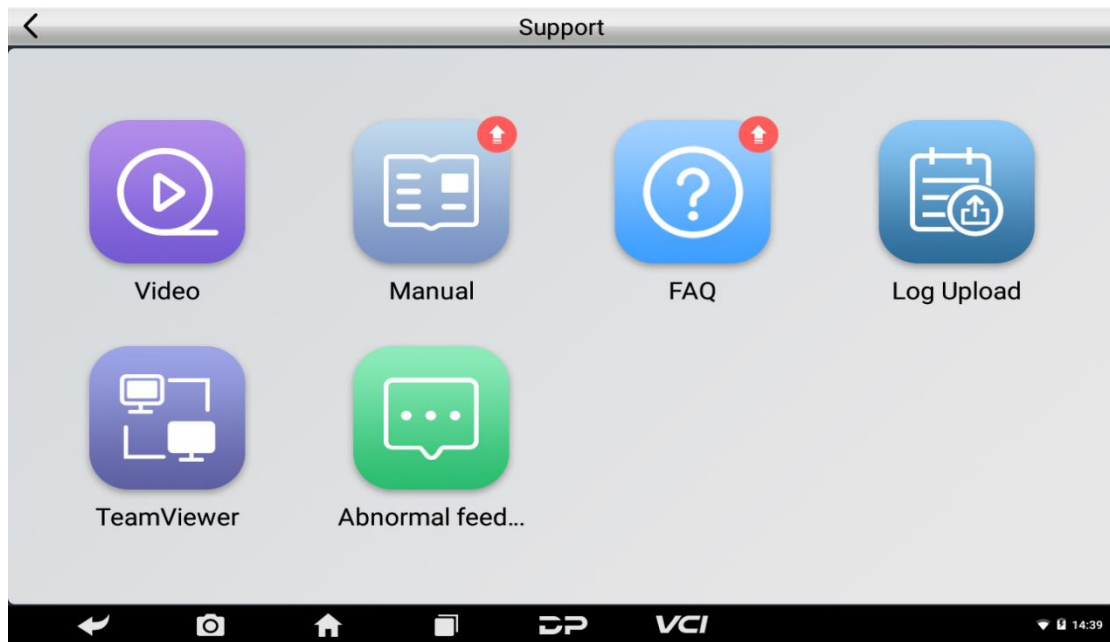

7.1. Video

Scan the QR code, you can watch the operation videos.

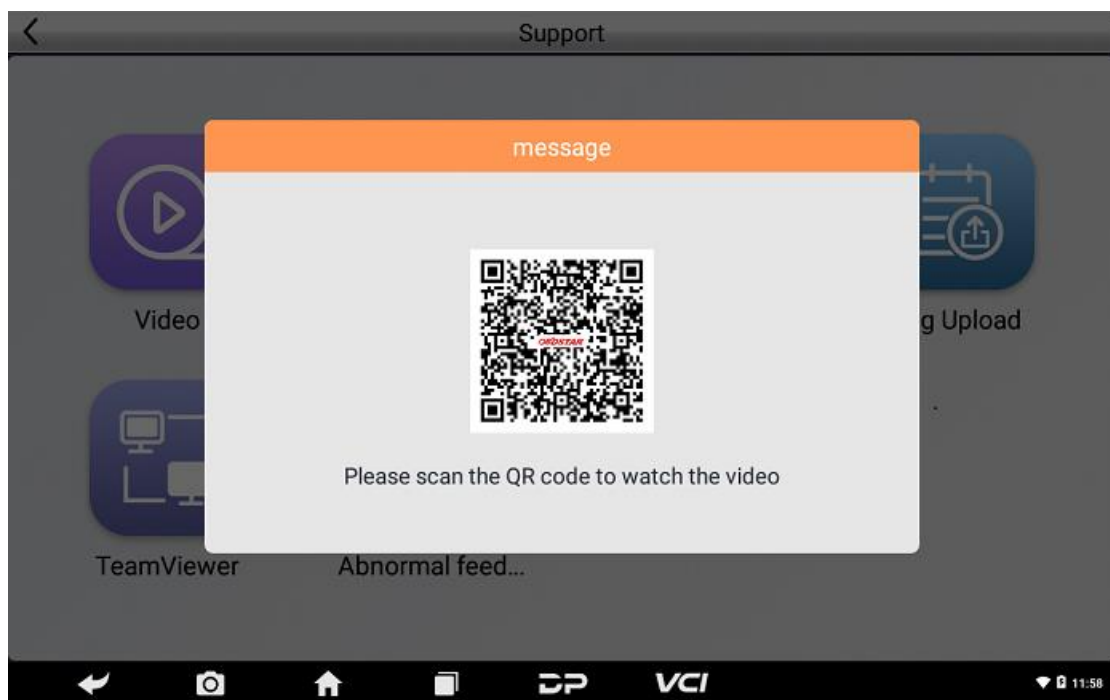

7.2. Manual

It gives a detailed introduction of this product, and exhibits the Introduction, Diag Notes, Upgrade, Others, Remark and Accessories Description.

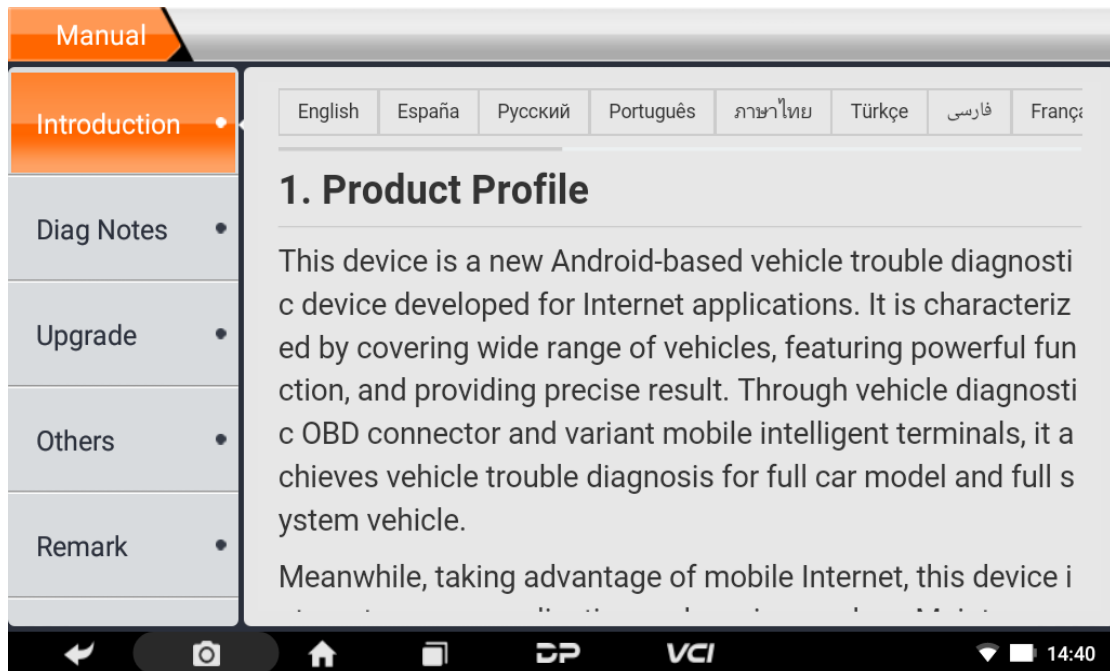

7.3. FAQ

It summarized some common problems you may encounter when using this product.



7.4. Log Upload

For problems encountered during diagnosis, you can upload logs for feedback.

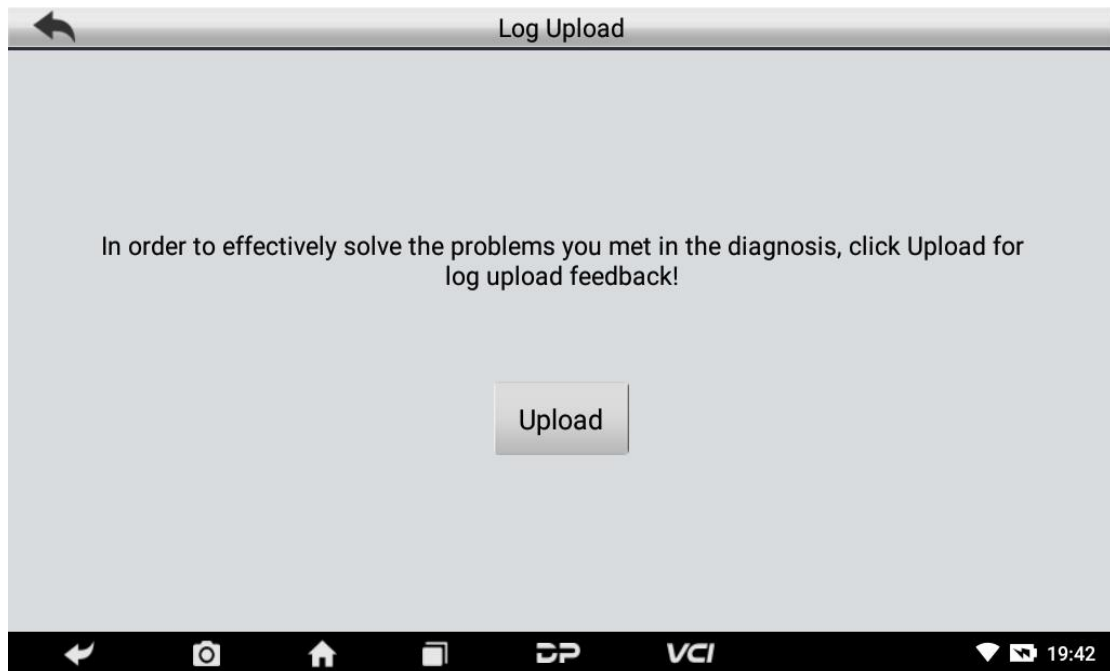

7.5. TeamViewer

This function can realize remote hosting via third party's software: "QuickSupport" or "AnyDesk". (Note: If only QuickSupport is detected when you need to use AnyDesk, you can return to the main menu interface to enter.)

- QuickSupport:

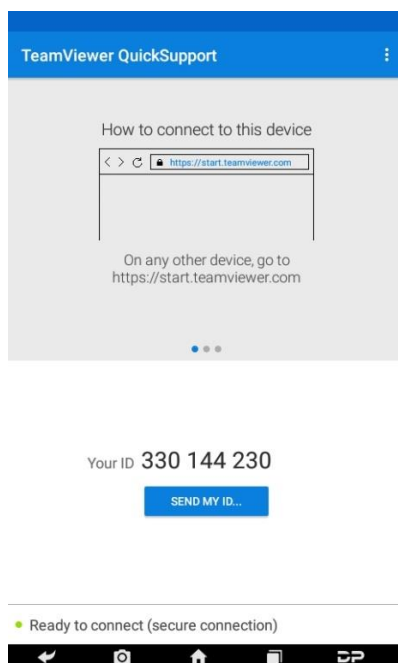

- AnyDesk:

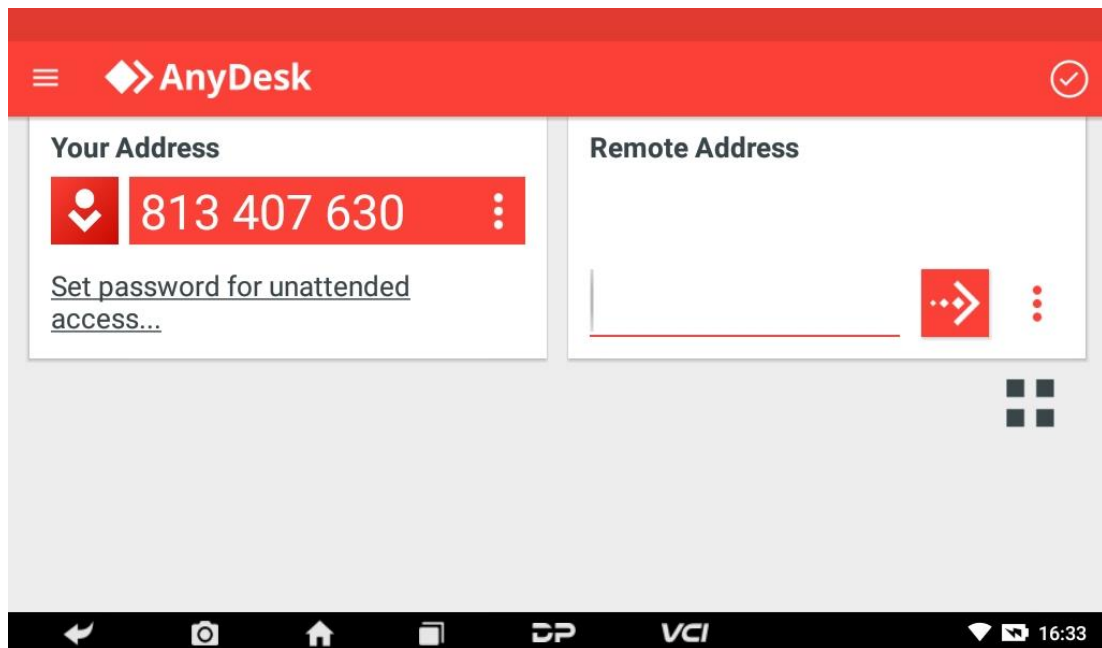

7.6. Abnormal Feedback

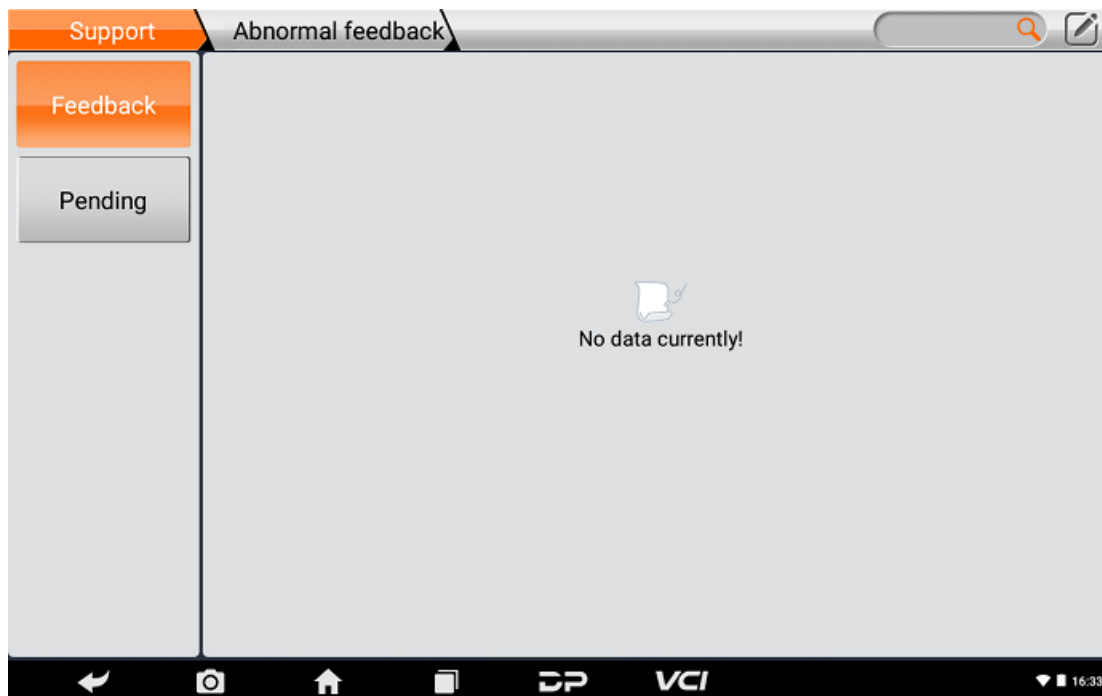

8. Settings

It includes VCI Info, Language, Unit, Workshop, Network Test, Clear cache, System Settings, and About.

8.1. VCI Info

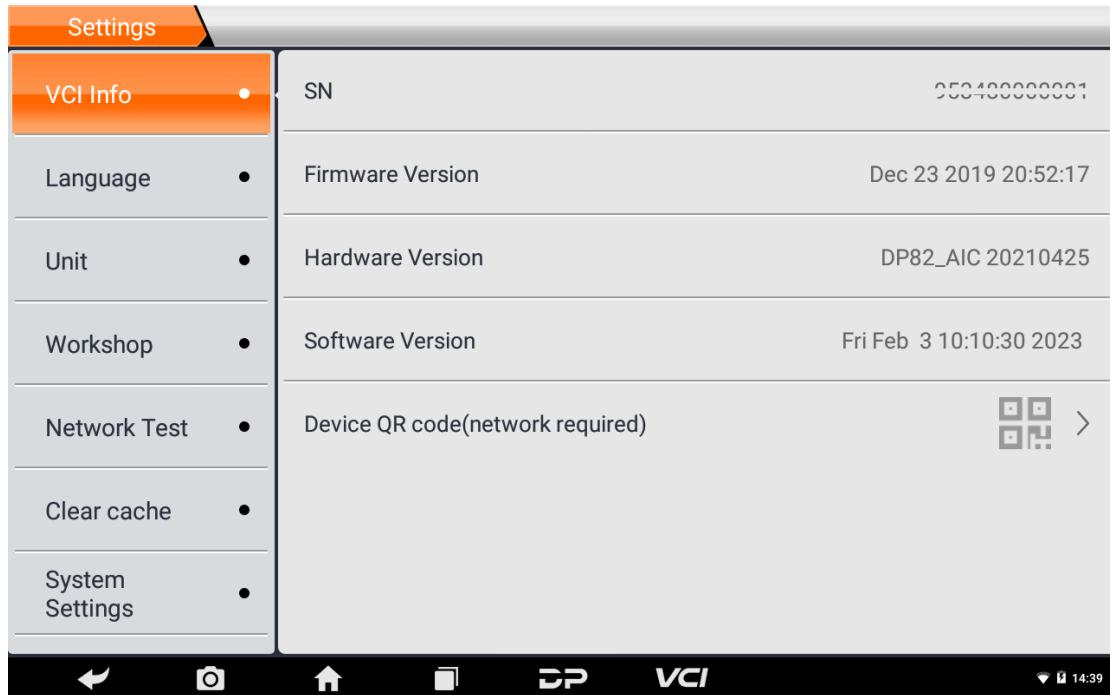

8.2. Language

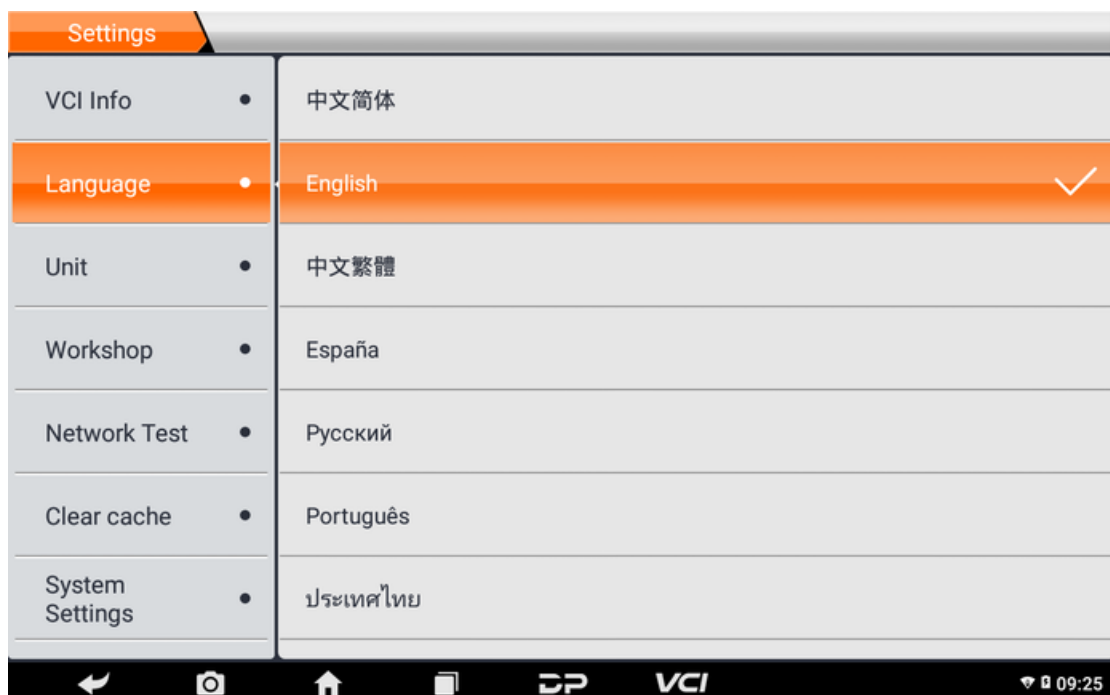

8.3. Unit

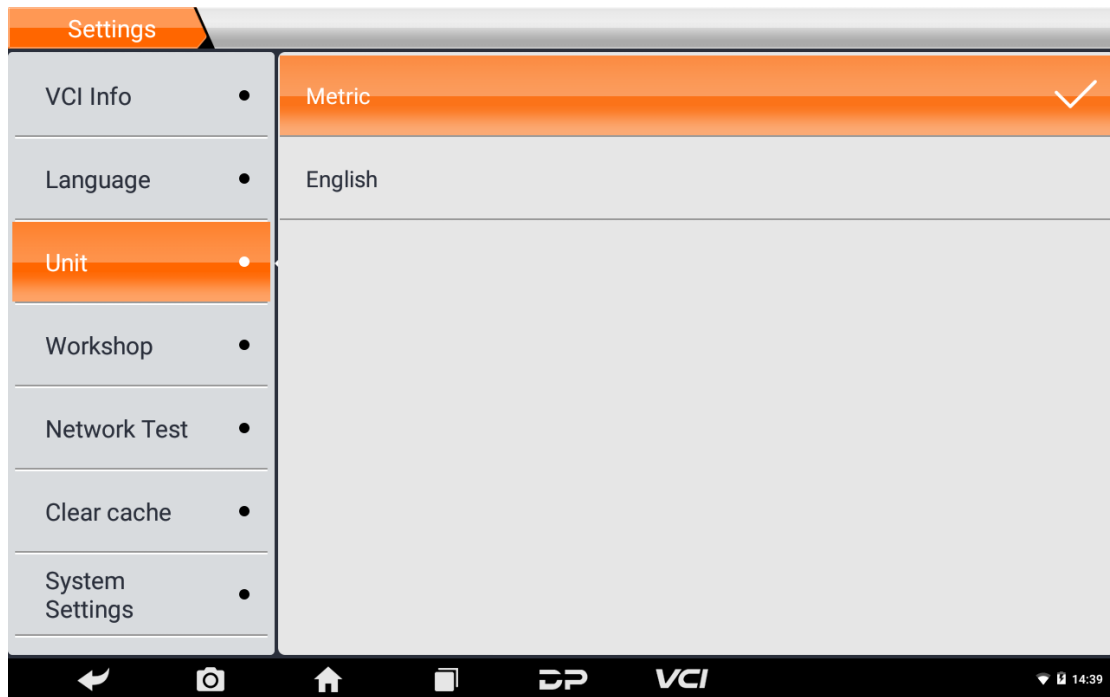

8.4. Workshop

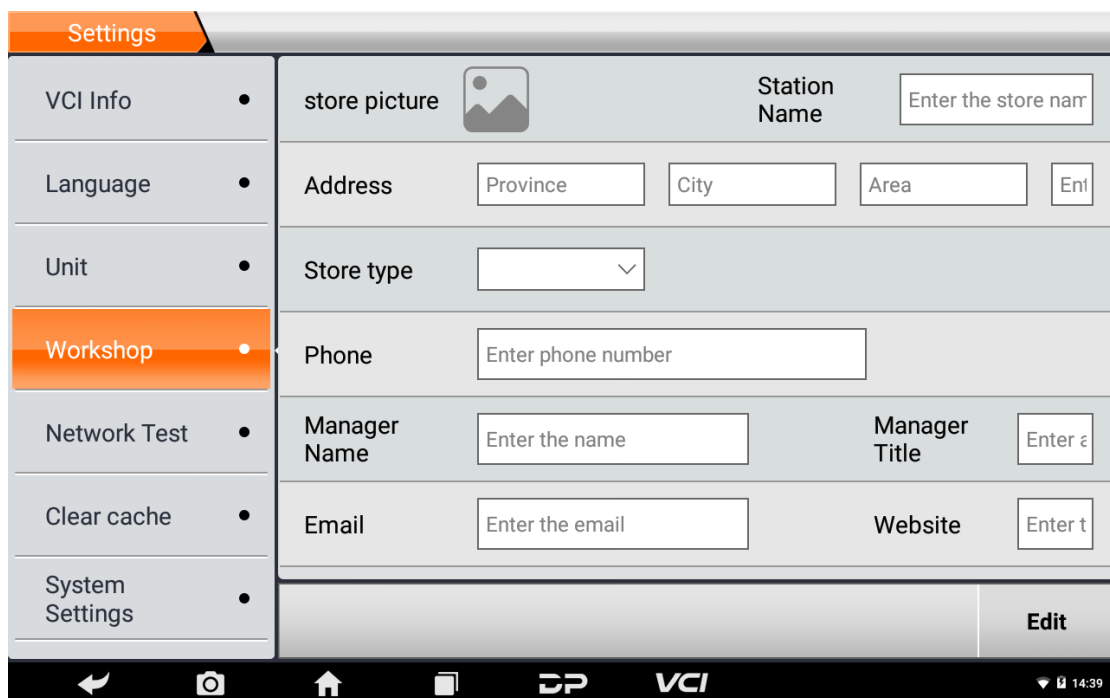

8.5. Network Test

The network test function is used for network connection failure and other phenomena during use. After you perform the test and

submit the logs, engineers can analyze the network status of the device through the test log.

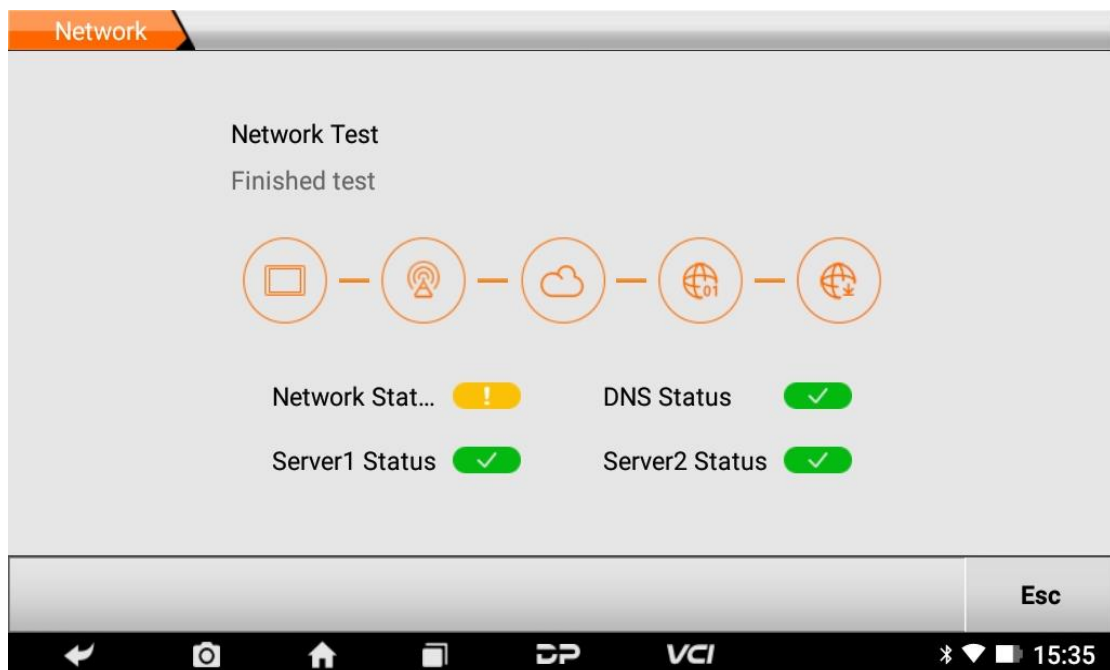
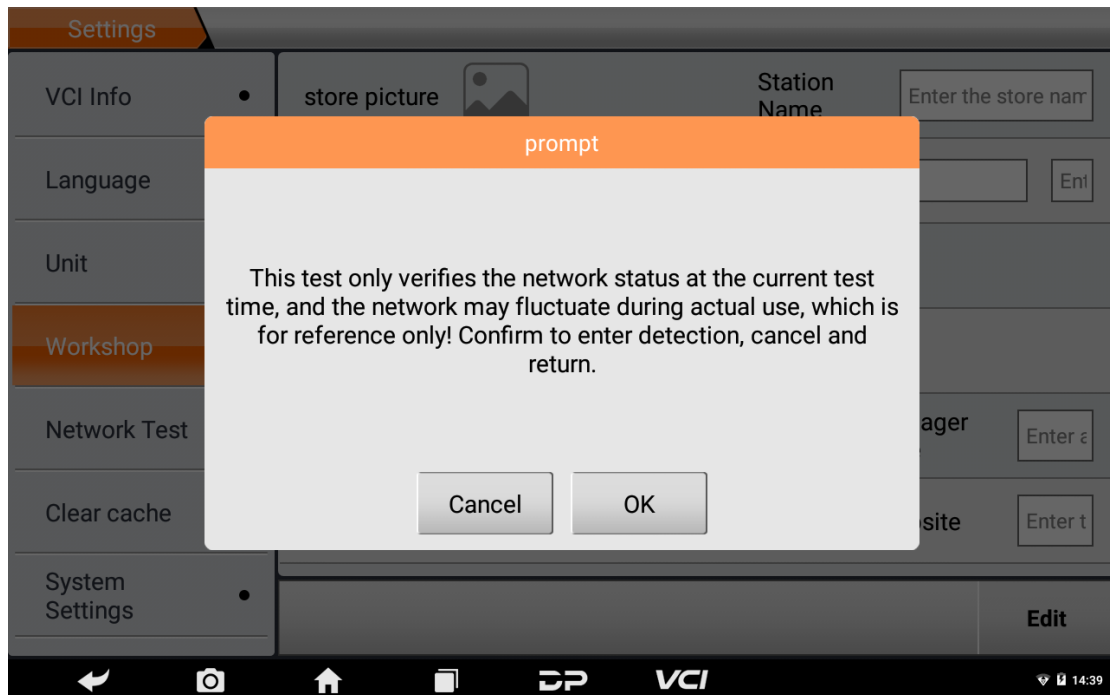

8.6. Clear Cache

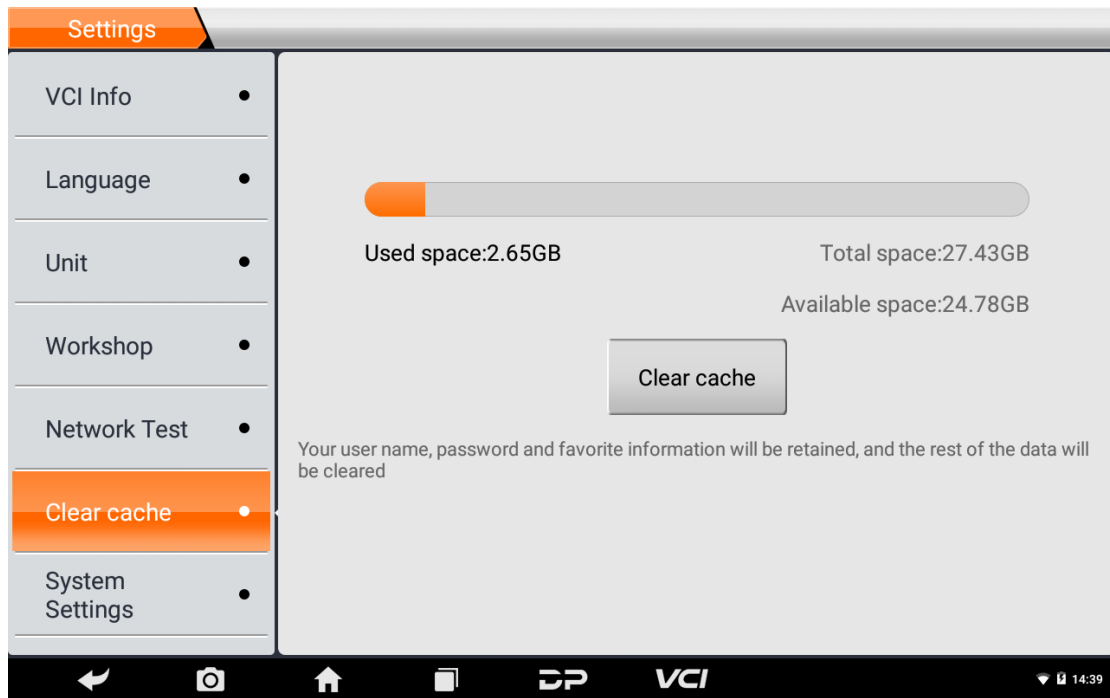

8.7. System Settings

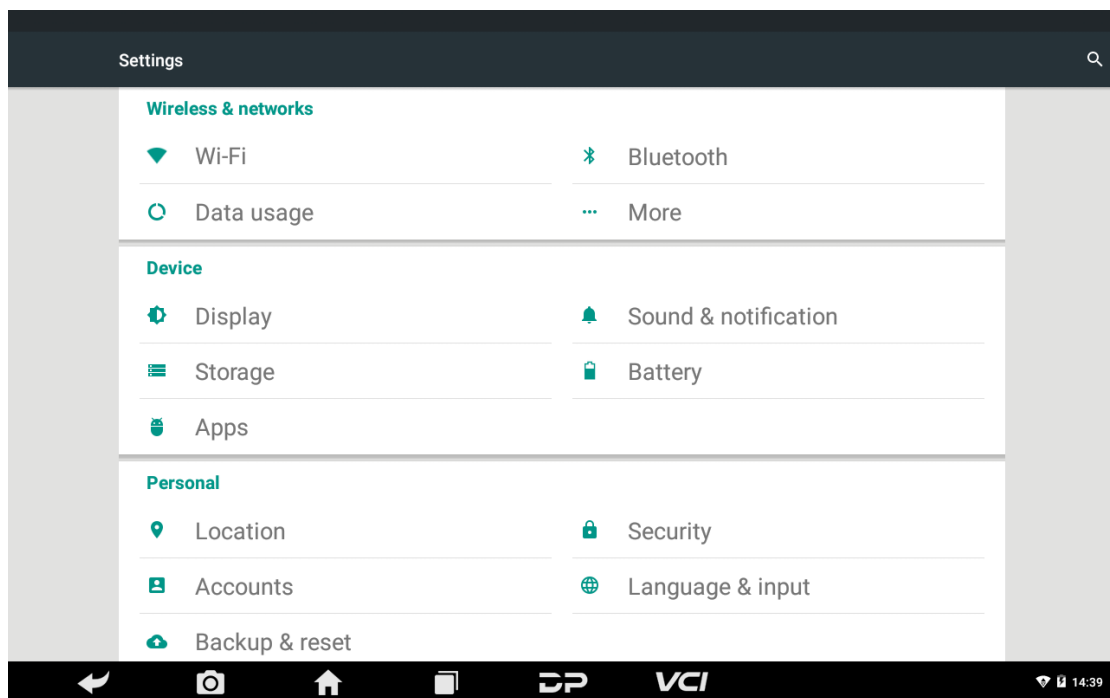

8.8. About

It displays software version updates and product announcements.

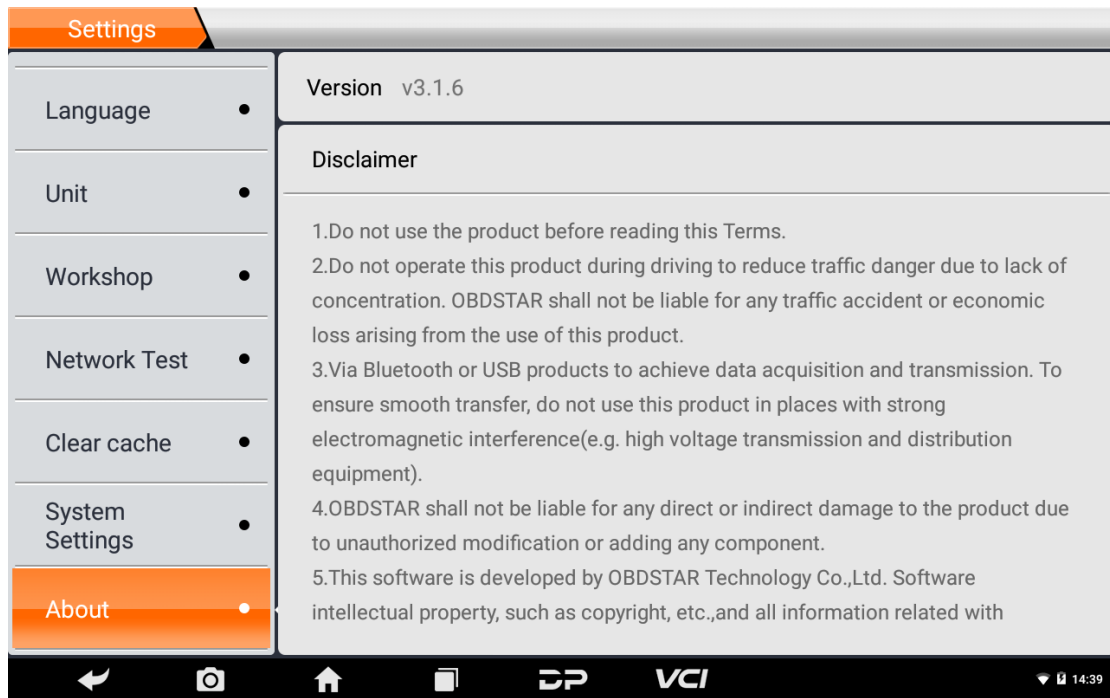



Chapter 4: Others

1. Email

This function allows you to send and receive emails. You can add common web email service provider to this device. For example: Yahoo!®, Sohu, 163 and external device POP3 or IMAP email account of other manufacturers.

1.1. Add An Email Account

Note: Before sending or receiving emails, you have to set up an email account. In addition, this function requires a stable network connection.

- a) On the desktop, tap  to enter main menu, then tap .
- b) Input an email address, tap "next step" or "manual setup".
- c) Tap the desired account type (here take POP3 as an example) to enter the incoming settings screen, tap "Next".
- d) Configure some sending settings, and tap "Next" to enter frequency settings.
- e) After setting, tap "Next" and the system will prompt account setup has been finished.
- f) Tap "Next" to enter email main menu.

1.2. Delete An Email Account

- a) Enter the main menu, and tap to enter account screen.
- b) Tap the desired account, and then tap to choose "Settings".
- c) Tap the account to be deleted and enter, then scroll the screen until "Remove account" appears and tap it to delete.

1.3. Send An Email

- a) Enter the main menu, and tap to enter account screen.

-
- b) Tap the desired email account.
 - c) Tap to enter new mail writing interface.
 - d) Input the receiver address into the field.
 - e) Input a title in Subject column.
 - f) Enter the content in Compose email area.
 - g) After the input is complete, you can perform any one of the followings: attach file, add CC/BCC, save draft, discard and setting.
 - h) Tap to send email.

1.4. View email

- a) Enter the main menu, and tap to enter account screen.
- b) Tap the desired email account.
- c) Tap to refresh the inbox.
- d) Tap the desired one to read.

2. Wi-Fi

This function enables you to enjoy surfing on the Internet and downloading data from the Internet via Wi-Fi.

2.1. Turn on WLAN

- Enter main menu screen, choose "Settings" > "WLAN"
- When the WLAN sign appears blue, it indicates WLAN has been activated already.

Note: To prolong the battery life, please switch WLAN off when unattended.

2.2. Connect to WLAN

After WLAN is enabled, if the device is within WLAN range, it will automatically detect and connect to the available WLAN. Select the desired network and input password, then you can surf the internet.

3. Browser

You can access and use web pages and web-based applications.

3.1. Open the Browser

Enter the main menu interface, click the browser to enter the homepage. You can choose the desired homepage or input a website address to browse.

- Tap to input or edit the web link.



- Web page display area.
- Tap  to view bookmarks, history and saved pages.

3.2. Browser Webpage

- Open the browser.
- Input the web address, and tap the arrow symbol on the keyboard to visit the website.

Tips: You can also select the web link you would like to visit from "Bookmarks/History".

- Once a webpage is open, slide the screen with your fingertip to view other hidden content.

3.3. Zoom In/Zoom Out the Page

You can do the following to zoom in/out while browsing a webpage.

- Tap the screen twice quickly to zoom in on the page, and double-tap the screen to zoom out.

-
- Focus two fingers on the screen where you would like to adjust, then stretch your fingers outward to zoom in on the page, or pinch your fingers together to zoom out.

Note: This function is not specific to the browser only.

3.4. Save Favorite Webpages to Bookmarks

- While browsing a webpage, tap  and choose "Save to bookmarks".
- Edit a label for the bookmark.
- Tap "OK" to confirm and save it.

3.5. Open Multiple Pages

The browser allows you to open multiple web pages and toggle between them.

- While browsing a webpage, tap  to open a new window.
- Enter another web page in the new window.

3.6. Customize Internet Settings

Enter the browser, tap the upper right dots and select "Settings" in the drop-down box, you can view or change browser general settings, privacy & security, accessibility, advanced settings, etc.

4. Calculator

You can use the calculator to perform addition, subtraction, multiplication and division operations, as well as function operations for sin, cos, tan and log.

5. Calendar

This function allows you to view calendar or create to-do lists. Enter main menu screen, tap "Calendar". Swipe up and down to switch months; Tap a day, the followings can be done. Tap  to refresh, search, and hide controls and settings.

6. Camera

6.1. Turn On/Off the Camera

Enter the main menu, tap camera. In shoot mode, tap back button to exit the camera.



6.2. Take a Photo

- a) Open camera, select whether to remember the shoot spot of the photo? Tap the next step.
- b) In shoot mode, aim the camera lens at the object you want to photograph and adjust it as desired.
- c) Tap  to take a photo.

6.3. View a Photo

- a) After a picture is taken, the picture will be stored automatically. Swipe the screen leftwards to view the photo.
- b) While browsing a picture, you can do any one of the followings:
 - Tap to delete the picture.
 - Share, tap to send this picture to your friend or upload it online.
 - Edit, beautify the photo, and view the detailed information of the photo.
 - Tap the back button on photo interface to return to the shoot mode.
- c) Swipe the screen rightwards or leftwards to view the next/previous picture.

6.4. Record a Video

- a) Open the camera, and swipe the screen rightwards to display button , and switch to video mode.
- b) Aim the camera lens at the object you want to photograph and adjust it as desired.
- c) Tap  to start recording.



d) Tap  to stop recording.

6.5. View a Video

a) After a video is recorded, the video will be stored automatically. Swipe the screen leftwards to view the video.





b) The following operations can be done:

- Delete: to delete the video.
- Share: to send this video file to your friend or upload it online.
- Tap the back button to return to the view state.

c) When the video is playing, swipe the screen leftwards and rightwards to control the speed of video playing, and tap  to stop video playing, or tap  to start video playing.



6.6. Customize Camera Settings

In camera mode:

- Tap  to enter camera setting screen;
- Tap  to set camera sudoku mode;
- Tap  to turn on /off flash mode;
- Tap  to set timer of selfie, 3s or 10s.

6.7. Customize Video Camera Settings

In video mode:

- Tap  to enter video setting screen;
- Tap  to turn on/off flash light;
- Tap  to turn on/off sudoku mode.

7. Gallery

This option is used to manage pictures and video files.

7.1. Open the Gallery



Enter main menu screen, tap "Gallery" to access it. The system searches images and videos in this device and SD card automatically, and categorizes it into corresponding folders.

7.2. View a Photo

1. Enter main menu screen, tap "Gallery".
2. Tap the picture folder you want to view.
3. Tap the desired image to browse.
4. Swipe the screen rightwards or leftwards to view the next/previous picture.

8. Clock

8.1. Add an Alarm

- a) Enter main menu, and tap "Alarm".
- b) Tap  to add alarms.
- c) Set the detailed information of the alarm.
- d) Tap  to pack up the alarm to store the setting.

8.2. Delete an Alarm

- a) Enter main menu, and tap "Alarm".
- b) Tap the desired alarm.
- c) Tap  to delete it.





Tips: After the alarm is deleted, you can choose to cancel the deleted alarm on the right side from the option menu.

8.3. Customize Your Alarm

- a) Enter main menu, and tap "Alarm".
- b) Tap menu button, and then choose "Settings".
- c) Alarm volume: Set the volume of alarms.
- d) Set the duration of alarm.
- e) Set the duration the alarm snooze next time.





-
- f) Volume buttons: set what these buttons function when pressed during an alarm.
 - g) Set default ringtone: choose the alarm ringtone.

8.4. Timer Setting

- a) Enter the main menu to tap  to choose timer;
- b) Set countdown time;
- c) Tap  to add timer, and tap  to delete;
- d) Tap  to start the timer, and tap  to stop counting down;

Note: when the countdown ends, the device will sound an alarm.

8.5. Stopwatch Setting

- a) Enter the main menu to tap  to choose stopwatch;
- b) Tap  to start stopwatch, and tap  to stop;
- c) Tap  to reset the stopwatch;
- d) Tap  on the right side to display the smaller unit counter of the stopwatch;

9. Music

Music files are stored into 4 categories: Artists, Albums, Songs and Playlist. Tap the desired music to play music.

Tips: While playing, tap the back button to switch to other applications and the player will be running in background. Open the status bar and choose the audio file to return to the player screen.

10. ES File Explorer

Open ES file viewer and enter the main menu. You can manage SD card, browse by category, and browse and manage all music, pictures, video, document application, package, favorites, installation package, commendations, etc.

11. Display

11.1. Brightness

1. Enter the main menu screen, tap "Settings" > "Display".
2. Tap "Brightness" to enter.
3. Drag the slider leftward to lower the screen brightness. Drag the slider rightward to increase the screen brightness.

11.2. Auto-Rotate the Screen

1. Enter the main menu screen, tap "Settings" > "Display".
2. When setting the rotation of the device, keep the orientation of the rotated screen.

12. Set Screen Lock

You can set a screen lock pattern. When the screen is locked, it will not be unlocked until you draw the right pattern.

- a) Enter the main menu screen, tap "Settings" > "Security" > "Screen lock".
- b) There are several options available for your selection. To define a pattern, follow the on-screen prompts to draw your pattern.
- c) After drawing, tap "Confirm" to save your setting.

13. Application

13.1. View Installed Applications

- a) Enter the main menu screen, tap "Settings" > "Apps" to open the downloaded application list.
- b) The following operations can be done:
 - Tap the desired one to view the application information.
 - Tap and choose "Sort by size" from the pull-down menu, the applications will automatically appear in size order.

-
- Tap and choose "Reset app preferences" from the pull-down menu, a confirmation dialog box will appear on the screen, tap "Reset apps" to proceed; tap "Cancel" to abort.
 - c) To uninstall an application, tap it to enter the application information screen.
 - d) Tap "Uninstall" and then follow the on-screen instructions to finish it.

13.2. View the Running Applications

- a) Enter the main menu, tap "Settings" > "Apps". Swipe the screen from right to left to the RUNNING tab, and you can check the list of currently running applications.
- b) The following operation can be done:
 - Tap any one of the currently running apps to stop it.

14. Language & Input

14.1. Language Setting:

- a) Enter the main menu screen, tap "Settings" > "Language & input"> "Language".
- b) Tap "Language" and choose the desired language in this device.

14.2. Input Method Setting:

The device provides several kinds of input methods. Tap setting before the desired input method.

15. Set Date & Time

This device is preset to use the network-provided date, time zone and time. Note: If Automatic date & time is set as Use network-provided time, date, time and time zone will not be defined.

- a) Enter the main menu screen, and tap "Settings" > "Date & time".

-
- b) Tap "Set date", and scroll the screen upwards or downwards until the desired number appears in the highlight area.
 - c) Tap "Select time zone", and choose the desired one from the time zone list. Scroll the screen upwards or downwards to view more.
 - d) Tap "Set time" and scroll the screen upwards or downwards to adjust the hour and minute. After setting, tap "Done" to confirm.
 - e) Select or deselect "Use 24-hour format" to switch between 12-hour format and 24-hour format.
 - f) Tap "Choose date format" to choose the desired date for this device format from the list.

16. Restore to Factory Settings

This option enables you to restore this device to the default factory settings. Once it is reset, all data (including downloaded applications) will be deleted. Note: Before factory data reset, please back up all important data saved in your device.

- a) Enter the main menu screen, tap "Settings" > "Backup & reset" > "Factory data reset".
- b) Follow the instructions on the screen to proceed.

17. Storage

Enter the main menu, and tap "Settings"> "Storage", check the storage conditions of the device. Store downloads in the default browser to the download list.

18. App Installation/Uninstallation

- Install: Put the application package in the root directory of the SD card, enter "File Manager", and then tap the desired package to start installing.
- Uninstall: Tap "Settings" > "Apps", and choose the desired one to uninstall.

Chapter 5: FAQ

1. Startup Failure

In case of startup failure, please connect the in-package DC power supply and the device can be turned on while charging. If the battery is too low, it may take a few minutes. If the device is still unable to be powered on, please contact after-sales and return to the factory for repair. It may not be able to boot when the ambient temperature is lower than -20°C. Please power on the device in a proper environment. After the device is turned on, it will not be affected by the temperature and can work smoothly.

2. Touchscreen Interference

In case of any abnormal touchscreen, please power off or restart the device, or eliminate static electricity on hands. If the touchscreen is still abnormal, please contact after-sales and return to the factory for repair.

3. Slow or Failed Upgrade

Check if the Wi-Fi connection is normal and the signal is good. If it cannot be solved, please check whether the upgrade period has expired. If so, please contact after-sales to solve it.

4. Crash

If any crash occurs, please long press the power button for more than five seconds to power off the device and then restart.

5. Test Failure

Solution: Exclude software problems ----- re-upgrade the newest software ---- unable to solve ---- offer feedback ---- Exclude vehicle problems ---- the vehicle is flawless ---- (if permitted) exclude main cable problems ---- replace with another main cable of the same

type ---- determined that the problem was with the device and send it back to repair (along with the main cable).

6. Unable to Charge

Check if the charger has a voltage output of 12V. In case of no voltage or abnormal voltage, please replace the charger; if it still doesn't work after replacement, please contact the after-sales service to return to the factory for repair (charger included).

7. Upgrade Software

Solution: DP interface ---- register in personal center ---- log in with your account ---- open the Upgrade app ---- Tick the software to be upgraded ---- click upgrade and done (See Manual for detailed steps, Diag Notes/Personal Center and Upgrade).

8. Delete Software

Method 1: DP ---- Data Management ---- Uninstall Models ----Tick the model to be uninstalled --- Click delete mark in the upper right corner of the screen.

Method 2: Enter the DP interface, click the vehicle logo, enter the software version page, tap and hold until a prompt appears, and then select delete.

9. Switch the System Language

Enter by clicking the multi-function icon in the main interface, select "Settings" ---"Language & input" --- "Language" and then select the desired language.

Chapter 6: Remarks

1. Copyright Information

Without the written consent of OBDSTAR Technology Co., Ltd. (hereinafter referred to as " OBDSTAR"), no company or individual shall copy and back up this manual in any form (electronic, mechanical, photocopying, recording or other forms).

This manual is specially designed for the use of OBDSTAR products, the company does not assume any responsibility for the consequences caused by using it to guide the operation of other equipment.

This manual and all examples contained therein are subject to change without notice.

OBDSTAR and its affiliates shall not be responsible for any damages, losses, or accidents caused by the user or a third party who abuses or misuses the equipment, changes or repairs the equipment without authorization, or fails to comply with the operation and maintenance requirements.

OBDSTAR shall not be liable for any damages or problems of the equipment caused by the use of other optional accessories or consumables rather than the original products of OBDSTAR or the products approved by OBDSTAR.

This equipment is for professional technicians or maintenance personnel.

2. Trademark Information

OBDSTAR is the trademark of OBDSTAR Technology Co., Ltd., which has been registered in China and several overseas countries. In countries where OBDSTAR's trademarks, service marks, domain names, logos and company names have not been registered, OBDSTAR declares that it retains its ownership rights in the unregistered trademarks, service marks, domain names, logos and company names. For other products mentioned in this manual, without the written consent of the owner, no one may use the trademark, service mark, domain name, logo, company name of

OBDSTAR or other companies mentioned. You can visit our official website at www.obdstar.com for product information, or write to OBDSTAR Technology Co., Ltd., at Room 1901, Building T1, Hi Park, Luozu Community, Shiyan Street, Bao'an District, Shenzhen City, Guangdong, P.R.China, to obtain the right to use the Manual and written consent.

3. Safety Precautions

Before using this device, please read the following safety information carefully. For more detailed information, see the appendix "Safety Warnings and Precautions".

- Do not bump, throw, or puncture this product, and avoid dropping, crushing, or bending.
- Do not use this device in exceptionally cold or hot, dusty, damp or dry environments.
- In places where this device is forbidden or using this device may cause interference or generate a potential risk, please turn off it.
- Do not use this device while driving.
- At medical sites, please observe the relevant regulations or rules, in areas close to medical equipment, please turn off this product.
- Turn off this device before boarding an airplane.
- In the vicinity of high-precision electronic equipment, please turn off this product, otherwise it may cause electronic equipment failure.
- Do not dismantle this device by yourself. If there is any inquiry, please contact the dealer.
- Do not place this product and accessories in appliances with strong electromagnetic fields.
- Keep this device far away from magnetic devices because their radiations may erase the data stored in this device.
- Do not use this device in high temperature and other environment with flammable gas, such as gas station.
- Keep this device out of the reach of children and do not allow children to use it unsupervised.
- Please use the battery and charger specified by the company. Otherwise, explosion may happen.

-
- Comply with laws and regulations and respect people's privacy and legal rights when using this product.

4. Precautions on Using This Device

The ignition switch should be OFF while plugging or unplugging the diagnostic connector.

5. Precautions for ECU Operation

- Do not disconnect the inner consumer when the ignition switch is on. High voltage transients may occur when disconnected, which can damage sensors and the ECU.
- Please do not place magnetic objects close to the computer, so as not to cause circuit and component failure in the ECU.
- Do cut off the power supply of ECU system before performing any welding operations on the vehicle.
- Be more careful when carrying out repair work close to the ECU and sensors to avoid damage to them.
- When disassembling and installing the programmable read-only memory (PROM), the operator should wear a grounding metal strap, wrap one end of it around the wrist, and clamp the other end on the vehicle body to avoid ECU circuit failure caused by static electricity.
- Do connect ECU harness connector firmly to avoid damage to electronic components such as integrated circuits inside the ECU.

6. Safety Warnings and Precautions

Before using or operating the device, please read and observe the following precautions to avoid dangerous or illegal conditions and to ensure the best performance of this device.

7. Medical Equipment

- In the express provision for healthcare facilities that prohibits the use of wireless equipment, please comply with the provisions of the premises to shut down this device.

-
- Radio waves generated by this device may affect the normal operation of implantable medical devices or personal medical devices such as pacemakers, cochlear implant, hearing aids. If you are using these medical devices, consult your manufacturer for restrictions on the use of this device.

8. Flammable and Explosive Area

- Do not use this device at a gas station (repair station) or near flammable materials or chemicals, and follow all graphic or text instructions. This device may cause an explosion or fire in or around fuel or chemical storage and transport areas or explosive atmospheres.
- Do not store or transport the equipment and its accessories in the same box as flammable liquids, gases or explosives.

9. Traffic Safety

- Do not hold this device while driving and comply with the regulations in your area or country.
- Do not place the device above the vehicle's airbag or in the area that can be reached after the airbag is deployed, otherwise, when the airbag is inflated, the device will be pushed by a strong external force, causing serious injury to the occupants.
- The wireless device may interfere with the aircraft's flight system, please comply with the relevant provisions of the airline. When the use of wireless devices is prohibited, please turn off this device.

10. Operating Environment

- Do not charge or use this device in a dusty, humid or dirty place, or near magnetic field, so as to avoid malfunction of the internal circuits of the device.
- Do not use this device during thunderstorms to avoid lightning strike or other damage.
- Turn off this device in places where the use of wireless devices is expressly prohibited.

-
- When the device is powered by a power adapter, the selection of product altitude is determined by the matching adapter. For the tropical ambient temperature conditions, keep the ambient temperature between 0°C and 40°C. When the device is powered by batteries, keep the ambient temperature between -10°C and 40°C. Do not use outside the aforementioned temperature range. When the ambient temperature is too high or too low, it may cause malfunction.

11. Child Health

- This device and its accessories may contain small parts, please keep them out of the reach of children.
- Children may unintentionally damage this device and its accessories, or swallow small parts to cause suffocation or other hazards.

12. Environmental Protection

Please comply with local ordinances regarding the disposal of devices, batteries and their accessories, and support recycling initiatives. Do not dispose of the device, battery and its accessories as ordinary household waste.

13. Original Accessories

Use only original accessories provided by the device manufacturer. If you use any non-original accessories, it may affect the performance of this device, violate the warranty terms of this device or the relevant national or regional regulations on communication terminal products, and even lead to personal hazard.

14. Usage of the Battery and the Charger

- When charging is complete, disconnect the device from the power outlet device.

-
- Do not connect metal conductors to the battery or touch the end of the battery, so as to avoid short circuits and bodily injury such as burns caused by overheating of the battery.
 - Do not place the battery or device around the heating equipment, such as a microwave oven, oven or radiator.

Batteries may explode when overheated.

- Do not disassemble or modify the battery to prevent the battery from leaking, overheating, igniting or bursting.
- If the battery leaks, do not expose your skin or eyes to the leaked liquid; if the leakage gets on the skin or eyes, rinse immediately with clean water and go to the hospital for medical treatment.
- If the charger's cable is damaged, please stop use it to avoid electric shock or fire.
- Do not throw the battery into the fire, otherwise the battery will catch fire and explode.

15. Repair and Maintenance

- Keep this device and its accessories dry. Do not use a microwave oven or other external heating equipment to dry it.
- Do not subject the device and its accessories to strong shocks or vibrations, so as not to damage the equipment and its accessories, or cause the battery to burn and explode.
- Do not expose the device or its accessories to excessively high or low temperatures, otherwise it may result in malfunction, fire or explosion of the device, battery and charger. When the temperature is below 0°C, the battery performance will be limited.
- Do not use potent chemicals, cleaning agents or strong detergent to clean the device or accessories. Before cleaning and maintenance, please turn off the device and disconnect the charger.
- Do not disassemble the device and its accessories, otherwise the device and accessories will not be covered by our warranty.

-
- If the device hits a hard object or the device is subjected to strong external impact and the screen is partially broken, do not touch or try to remove the broken part, and please stop using it immediately and contact the designated service point in time.

16. Warranty

The warranty is only applicable to users and distributors who purchase the company products through normal procedures.

Within one year from the date of delivery, the company warrants its electronic products against defects in materials or workmanship. Damage to the device or its components caused by abuse, unauthorized modification, the use for purposes not designed for this product, or the operation not in accordance with the instructions in the manual will not be covered by this warranty.

17. Order Notification

Replaceable parts and optional accessories can be ordered directly from the company's authorized supplier, please specify the following when ordering:

- Order quantity
- Serial number
- Part name

18. Customer Service Center

If you encounter any problem during the operation, please call our Service Hotline: +86-755-86707161.

When the device needs repair, please send it, together with the purchase invoice and problem descriptions, to OBDSTAR Technology Co., Ltd. If the device is covered under the warranty, the company will provide free maintenance; if the device is not under the warranty, the company will charge for repairs and add return freight.

OBDDSTAR Technology Co., Ltd. After-Sales Service Address:

Floor 2, Block B3, Junfeng Industrial Park, Chongqing Road, Peace Community, Fuhai Street, Bao'an District, Shenzhen, 51800, China

19. Disclaimer

OBDDSTAR reserves the right to change the product design and specifications without notice. Physical appearance and color of the actual product may be a little different from the one shown in the instruction manual, please refer to the actual device. We have made every effort to make all descriptions in the manual accurate, but some inaccuracies are still inevitable. If in doubt, please contact the dealer or after-sales service center. The Company shall not be liable for any consequences arising from misunderstandings.

Official statement: The names of other products mentioned in this manual are intended to explain how this equipment is used, and the registered trademark ownership still belongs to the original company.